



sonia[®]

FURNITURE, MIRRORS & LIGHTS
MUEBLES, ESPEJOS & LUCES

 **UNIVERSE**



EDITION / EDICIÓN
2022 - 2023

CATALOGUE / PRICELIST
CATÁLOGO / TARIFA





40 YEARS LOOKING FORWARD

Being part of Arco Valves group provides Sonia 40 years of industrial know-how DNA.

From design, selection of raw materials, manufacturing, packaging, logistics, after sales service. At Sonia, every step is key.

And today more than ever our commitment with the environment and social context.

Sonia is about passion, effort and the goal of being better.

40 AÑOS MIRANDO AL FUTURO

Haber nacido dentro del grupo industrial Válvulas Arco, nos permite hablar de más de 40 años de experiencia.

El diseño, la selección de materiales, la fabricación, el transporte, el servicio post-venta... para Sonia cada paso es relevante.

Hoy, más que nunca, tenemos un sólido compromiso con la desigualdad social, el apoyo a la cultura y el respeto por el medio ambiente.

No dejamos de aprender. La historia de Sonia se basa en el esfuerzo, tratar siempre de alcanzar la excelencia, conseguir el éxito y proporcionar la mejor respuesta al mercado.

HISTORY | 40 YEARS INDUSTRIAL EXCELLENCE BACKGROUND



1980

Ford Fiesta inside door handle.

Ford Fiesta maneta de la puerta interior.

1989

We are recipients of Ford's Q1 Certification.

Obtenemos la certificación Q1 de Ford.

90's

German leading brands such as Hansa, Hansgrohe, Grohe, and Dornbracht rely on our processes to produce some of their products.

Marcas líderes alemanas, como Hansa, Hansgrohe, Grohe y Dornbracht confían en nosotros para producir algunos de sus productos.



2007

E-Plus:
Simplicity and contract collection.

E-Plus:
Simplicidad y colección contract.

2013

S-Cube:
Expanding finish options.

S-Cube:
Ampliando la gama de acabados.

2015

S8 24K:
High end luxury collection.

S8 24K:
Colección lujosa de gama alta.

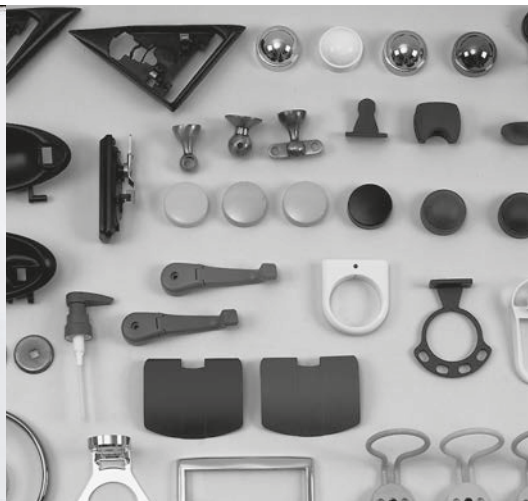

1991

Bola and Norda: The first two Sonia Collections.

Bola y Norda: Las dos primeras colecciones de Sonia.

1995

Our client data base increased with names like: Volvo, Jaguar, Volkswagen Valeo.

Nuestros clientes crecen con nombres como: Volvo, Jaguar, Volkswagen, Valeo.

2005

After developing 20 accessory collections, we expand our product range to vanities, washbasins, mirrors and lighting.

Después de 20 colecciones de accesorios, extendemos nuestra gama de productos a muebles, lavabos, espejos e iluminación.



2017

Luce: Functionality two high end materials with outstanding finishes.

Luce: Funcionalidad con dos materiales de alta gama con acabados excepcionales.

2019

Époque: Natural oak wood craftsmanship.

Époque: Artesanía en madera de roble natural.

2021

Quick: New functionalities.

Quick: Nuevas funcionalidades.

FURNITURE



FURNITURE MUEBLE

| | | EVOLVE | ÉPOQUE | MITTE | PLAY | CODE | PUZZLE |
|---|--------------------|-----------------|---------|-------|-------|-----------|--------|
| FINISHES ACABADOS | LACQUERED LACADOS | 2 | 3 | 2 | 2 | 1 | 2 |
| | MELAMINE MELAMINAS | 2 | - | 3 | 2 | 3 | - |
| | WOOD MADERA | - | 3 | - | - | - | - |
| MODULAR MODULAR | | YES | NO | NO | NO | NO | NO |
| THICKNESS ESPESOR | | 19 mm | 19 mm | 19 mm | 19 mm | 19 mm | 19 mm |
| HARDWARE | | YES | YES | YES | YES | YES | YES |
| HANDLES TIRADORES | TYPES MODELOS | 3 | 1 | - | 1 | - | - |
| | FINISHES ACABADOS | 4 | 5 | - | 5 | - | - |
| TYPES OF BASINS TIPOS DE LAVABOS | BASINS LAVABOS | YES | YES | YES | YES | YES | YES |
| | COUNTER ENCIMERAS | YES | NO | YES | NO | NO | YES |
| ACCESSORIES ACCESORIOS | | NO | NO | YES | NO | NO | NO |
| SIZES TAMAÑOS | <100 | 60 80 | 60 80 | 80 | 80 | 60 80 | 50 |
| | >100 | 100 120 140 | 100 | 100 | 100 | 100 120 | - |
| MOISTURE RESISTANT RESISTENTE A LA HUMEDAD | | YES | YES | YES | YES | YES | YES |
| PRICE PRECIO | | €€€ | €€€ | €€€ | € | €€ | € |

EVOLVE

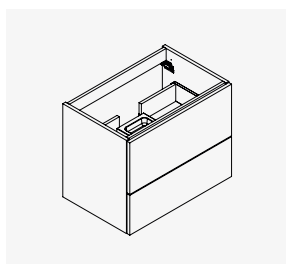

ÉPOQUE



MITTE

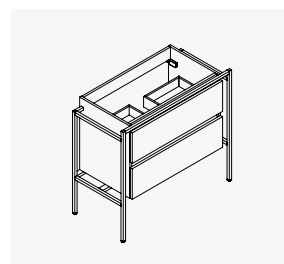

PUZZLE

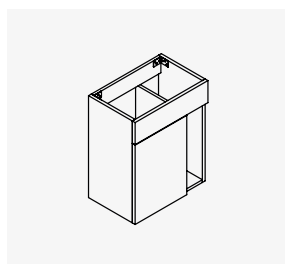

PLAY

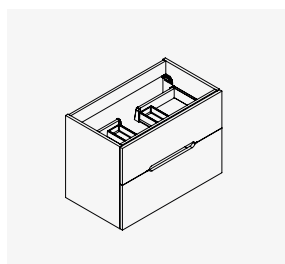

CODE

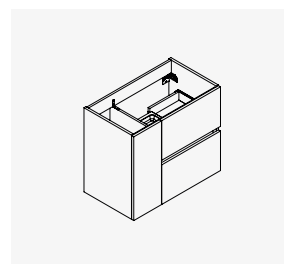

BASINS



BASINS LAVABOS

| | MX1 | MX3 | MX4 | MX8 | | MX10 | | SX7 | SX12 |
|--|---------------|-----------|-------------------|-----------|--------------|-----------|--------------|----------------|------|
| | MINERAL MARMO | | MINERAL COMPOSITE | | MINERAL | | CERAMIC | | |
| | GLOSS BRILLO | MATT MATE | GLOSS BRILLO | MATT MATE | GLOSS BRILLO | MATT MATE | WHITE BLANCO | COLORS COLORES | |
| IMPACT RESISTANCE RESISTENCIA A LOS IMPACTOS | MEDIUM | MEDIUM | HIGH | HIGH | MEDIUM | MEDIUM | LOW | LOW | |
| SCRATCH RESISTANCE RESISTENCIA RASGUÑOS | LOW | MEDIUM | LOW | MEDIUM | LOW | MEDIUM | HIGH | LOW | |
| CHEMICALS RESISTANCE RESISTENCIA A QUÍMICOS | MEDIUM | MEDIUM | MEDIUM | MEDIUM | MEDIUM | MEDIUM | HIGH | MEDIUM | |
| REPAIRABLE REPARABLE | YES | YES | YES | YES | YES | YES | NO | NO | |
| HOLE DRILLING PERFORACIÓN | YES | YES | YES | YES | YES | YES | NO | NO | |
| MINIMUM RADII (MM) RADIOS MÍNIMOS | 2 | 2 | 2 | 2 | 2 | 2 | 5 - 10 | 5 - 10 | |
| GLOSS INTENSITY INTENSIDAD BRILLO | HIGH | N/A | HIGH | N/A | MEDIUM | N/A | HIGH | HIGH | |
| MATT INTENSITY INTENSIDAD MATE | N/A | HIGH | N/A | HIGH | N/A | HIGH | LOW | LOW | |
| ABRASIVE CLEANING LIMPIEZA ABRASIVA | NO | OK | NO | OK | NO | OK | OK | NO | |

MX1

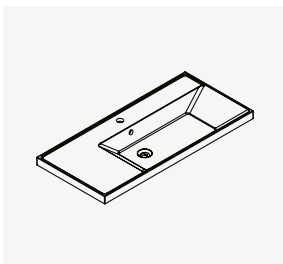

MX3

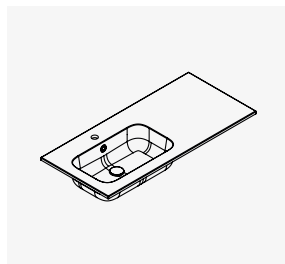

MX4

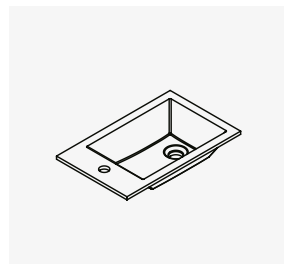

MX8

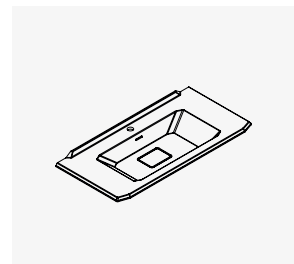

MX10

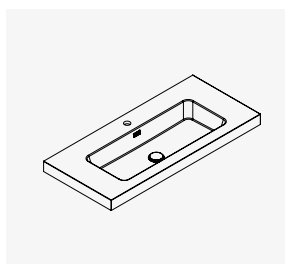

SX7

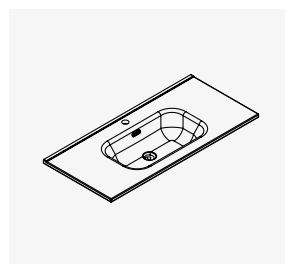

SX12

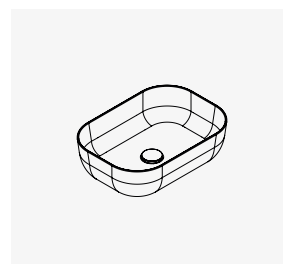

MINERAL MARMO SOLID

MX1 | MX3 | MX4

MX1



SPECS ESPECIFICACIONES

- Material: Mineral Marmo® (White Gloss).
Material: Mineral Marmo® (Blanco Brillo).
- Composition: 75% natural minerals (calcium carbonate and aluminum trihydrates), 25% polyester resin.
Composición: 75% minerales naturales (carbonato de calcio y trihidratos de aluminio), 25% resina de poliéster.
- Standard: 1 faucet hole.
Optional: 3 faucet hole.
Standard: 1 taladro.
Opcional: 3 taladros.
- Overflow: integrated.
Rebosadero integrado.
- Injection modeling.
Modelado por inyección.
- Drain 1 1/4".
Desagüe 1 1/4".

CABINET MATCH COMPATIBILIDAD

- Play.
- Code.

DIMENSIONS MEDIDAS

60

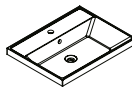

80

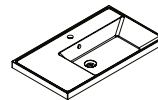

100

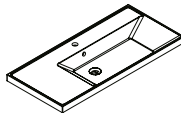

120

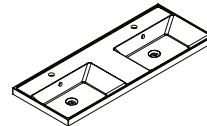

FINISHES ACABADOS

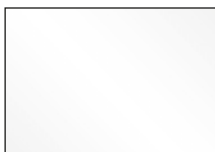

MINERAL MARMO
GLOSS WHITE
BLANCO BRILLO

MX3



SPECS ESPECIFICACIONES

- Material: Mineral Solid® (White Matt).
Material: Mineral Solid® (Blanco Mate).
- Composition: 75% natural minerals (calcium carbonate and aluminum trihydrates), 25% polyester resin.
Composición: 75% minerales naturales (carbonato de calcio y trihidratos de aluminio), 25% resina de poliéster.
- Standard: 1 faucet hole.
Optional: 0 or 3 faucet hole.
Standard: 1 taladro.
Opcional: 0 o 3 taladros.
- Overflow: integrated.
Rebosadero integrado.
- Injection modeling.
Modelado por inyección.
- Drain 1 1/4".
Desagüe 1 1/4".

CABINET MATCH COMPATIBILIDAD

- Play.
- Evolve.

DIMENSIONS MEDIDAS

60
Centered
Centrado

80
Centered
Offset Edge Right / Left
Centrado
Deplazado izq. / dcha.

100
Centered
Offset Edge Right / Left
Centrado
Deplazado izq. / dcha.

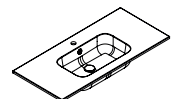
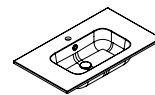

120
Double
Offset Edge Right / Left
Doble
Deplazado izq. / dcha.

140
Double
Doble

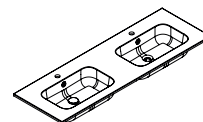
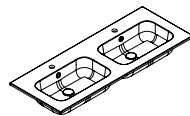

FINISHES ACABADOS



MINERAL SOLID
MATT WHITE
BLANCO MATE



MINERAL MARMO SOLID

MX1 | MX3 | MX4

MX4



SPECS ESPECIFICACIONES

- Material: Mineral Solid® (Matt White).
Material: Mineral Solid® (Blanco Mate).
- Composition: 75% natural minerals (calcium carbonate and aluminum trihydrates), 25% polyester resin.
Composición: 75% minerales naturales (carbonato de calcio y trihidratos de aluminio), 25% resina de poliéster.
- Standard: 1 faucet hole.
Optional*: without faucet hole.
Standard: 1 taladro.
Opcional*: sin taladro.
- Overflow: without.
Sin rebosadero.
- Drain 1 1/4".
Desagüe 1 1/4".

CABINET MATCH COMPATIBILIDAD

- Puzzle.

DIMENSIONS MEDIDAS

50

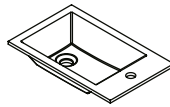

FINISHES ACABADOS



MINERAL SOLID
MATT WHITE
BLANCO MATE

*Consult conditions.
*Consultar condiciones.

MINERAL COMPOSITE

MX8

MX8



SPECS ESPECIFICACIONES

- Material: Mineral Rock composite ground with dolomite. Coated with nanolayer of quartz resin.
Material: Piedra Mineral compuesta con piedra dolomita. Recubierto con nanocapa de resina de cuarzo.
- Composition: 75% ground rock mineral, 25% resin.
Composición: 75% mineral de roca molida, 25% resina.
- Standard: 1 faucet hole.
Optional*: 0 or 3 faucet hole.
Standard: 1 taladro.
Opcional*: 0 o 3 taladros.
- Overflow: integrated.
Rebosadero integrado.
- Drain 1 1/4". Compatible with click clack or fixed valve with small lid.
Desagüe 1 1/4". Compatible con click clack o válvula fija con tapa pequeña.
- Valve cover.
Tapa de válvula.

CABINET MATCH COMPATIBILIDAD

- Époque.

DIMENSIONS MEDIDAS

60

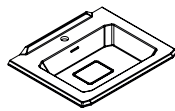

80

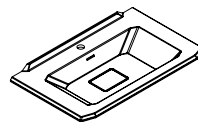

100

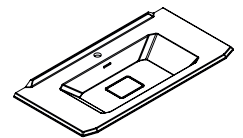

FINISHES ACABADOS

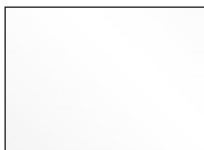

MINERAL COMPOSITE GLOSS
GLOSS WHITE
BLANCO BRILLO



MINERAL COMPOSITE MATT
MATT WHITE
BLANCO MATE

*Consult conditions.
*Consultar condiciones.

CERAMIC

SX7 | SX12

MX10



SPECS ESPECIFICACIONES

- Material: Mineral Solid® (Matt White).
Material: Mineral Solid®.
- Composition: 75% natural minerals 25% polyester resin.
Composición: 75% minerales naturales 25% resina de poliéster.
- Faucet hole:
Standard: 1 faucet hole.
Optional*: 0 or 3 faucet hole.
Standard: 1 taladro.
Opcional*: sin taladro.
- Overflow: integrated.
Sin rebosadero.
- Drain 1 1/4".
Desagüe 1 1/4".

CABINET MATCH COMPATIBILIDAD

- Mitte.

DIMENSIONS MEDIDAS

80

100

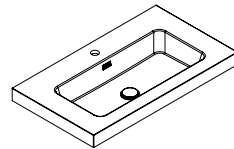
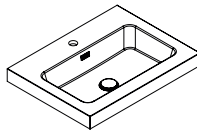

FINISHES ACABADOS

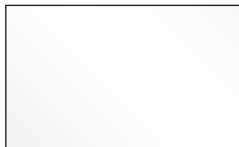

MINERAL GLOSS
GLOSS WHITE



MINERAL MATT
MATT WHITE

CERAMIC

SX7 | SX12

SX7



SPECS ESPECIFICACIONES

- Material: Glazed ceramic.
Material: Cerámica esmaltada
- Composition: natural material composed of clay and kaolin.
Composición: material natural compuesto de arcilla y caolín.
- Faucet hole:
Standard: 1 faucet hole.
Optional*: 0 or 3 faucet hole.
Standard: 1 taladro.
Opcional*: sin taladro.
- Overflow: integrated.
Sin rebosadero.
- Drain 1 1/4".
Desagüe 1 1/4".

CABINET MATCH COMPATIBILIDAD

- Play.
- Code.
- Essence

DIMENSIONS MEDIDAS

60

80

100

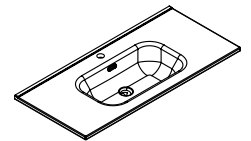
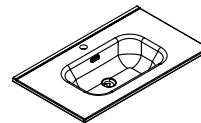
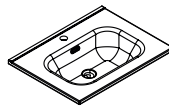

120

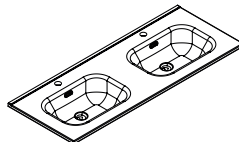

FINISHES ACABADOS

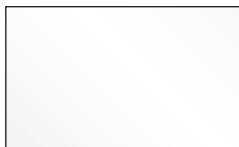

CERAMIC
GLOSS WHITE

CERAMIC

SX7 | SX12

SX12



SPECS ESPECIFICACIONES

- Material: Glazed ceramic.
Material: Cerámica esmaltada.
- Composition: natural material composed of clay and kaolin.
Composición: material natural compuesto de arcilla y caolín.
- Overflow: without.
Sin rebosadero.
- Drain 1 1/4".
Desagüe 1 1/4".
- 3 models.
3 modelos.



CABINET MATCH COMPATIBILIDAD

- Evolve with counter.
Evolve con encimera.
- Mitte whith counter.
Mitte con encimera.
- Puzzle with counter.
Puzzle con encimera.

DIMENSIONS MEDIDAS

44x32

Ø37

Ø28

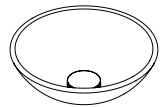
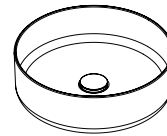
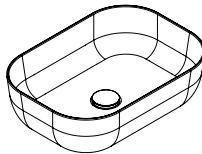

FINISHES ACABADOS



WHITE STONE



TORTORA STONE

*Consult conditions.
*Consultar condiciones.



COUNTERS

| | COUNTER | | | |
|---|---------------|-----------|---------------------|-----------|
| | STONE | | MINERAL MARMO SOLID | |
| | COMPACT STONE | MICROTECH | GLOSS BRILLO | MATT MATE |
| IMPACT RESISTANCE RESISTENCIA IMPACTOS | HIGH | MEDIUM | MEDIUM | MEDIUM |
| SCRATCH RESISTANCE RESISTENCIA RASGUÑOS | MEDIUM | MEDIUM | LOW | MEDIUM |
| CHEMICALS RESISTANCE RESISTENCIA A QUÍMICOS | MEDIUM | MEDIUM | MEDIUM | MEDIUM |
| REPAIRABLE REPARABLE | NO | NO | YES | YES |
| FAUCET HOLE DRILLING PERFORACIÓN | YES | YES | YES | YES |
| CUT CORTE | YES | YES | NO | YES |
| MINIMUM RADIUS (MM) RADIOS MÍNIMOS | 2 | 2 | 2 | 2 |
| MATT INTENSITY INTENSIDAD MATE | MEDIUM | MEDIUM | N/A | HIGH |
| GLOSS INTENSITY INTENSIDAD BRILLO | LOW | LOW | HIGH | N/A |
| ABRASIVE CLEANING LIMPIEZA ABRASIVA | NO | NO | NO | NO |
| MICROFIBER CLEANING LIMPIEZA MICROFIBRA | OK | OK | OK | OK |

STONE COUNTER

MICROTECH



SPECS ESPECIFICACIONES

- Material: Compact stone obtained from natural ground rock with a lamination process.
Material: Piedra compacta obtenida de roca molida natural con proceso de laminación.
- Impact resistant
Resistente a los impactos.
- Water proof.
Resistente al agua.
- Standard: 0 faucet hole.
Optional*: 1 or 3 faucet hole.
Standard: 0 taladro.
Opcional*: 1 o 3 taladros.
- Painted in different colors.
Pintada en diferentes colores.

COMPATIBILITY COMPATIBILIDAD

- Mitte. + Basin SX12.
- Evolve. + Lavabo SX12.
- Puzzle.

DIMENSIONS MEDIDAS

50

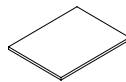

60

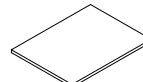

80

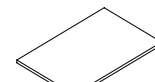

100

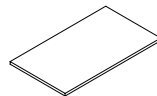

120

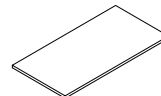

140

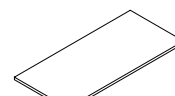

FINISHES ACABADOS

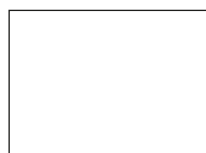

WHITE STONE



TORTORA STONE

*Consult conditions.
*Consultar condiciones.

STONE COUNTER

COMPACT



SPECS ESPECIFICACIONES

- Material: 100% natural stone counter ground and compacted.
Material: Encimeras de piedra 100% natural, molida y compactada.
- Impact resistant
Resistente a los impactos.
- Water proof.
Resistente al agua.
- Standard: 0 faucet hole.
Optional*: 1 or 3 faucet hole.
Standard: 0 taladro.
Opcional*: 1 o 3 taladros.
- To install on a base unit.
Para instalar sobre el mueble.

COMPATIBILITY COMPATIBILIDAD

- Evolve. + Basin SX12.
+ Lavabo SX12.

DIMENSIONS MEDIDAS

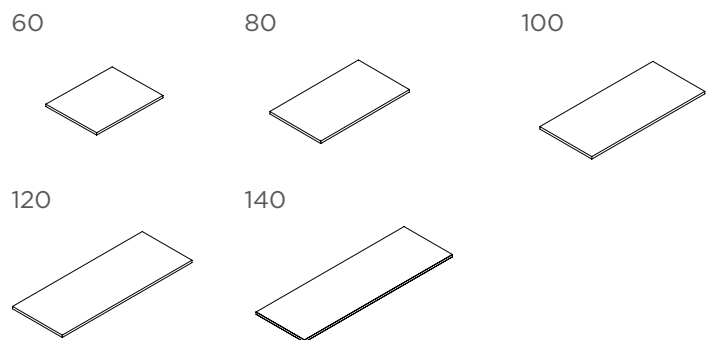

FINISHES ACABADOS

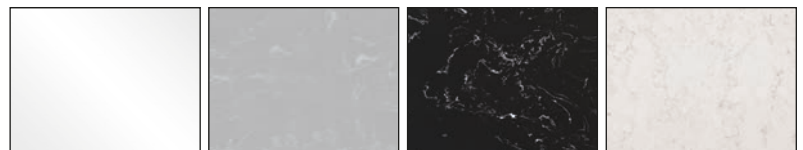

MINERAL MARMO

POLAR STONE

MARQUINA STONE

CALACATTA STONE

*Consult conditions.
*Consultar condiciones.

INDEX ÍNDICE





CODE · PAG 110

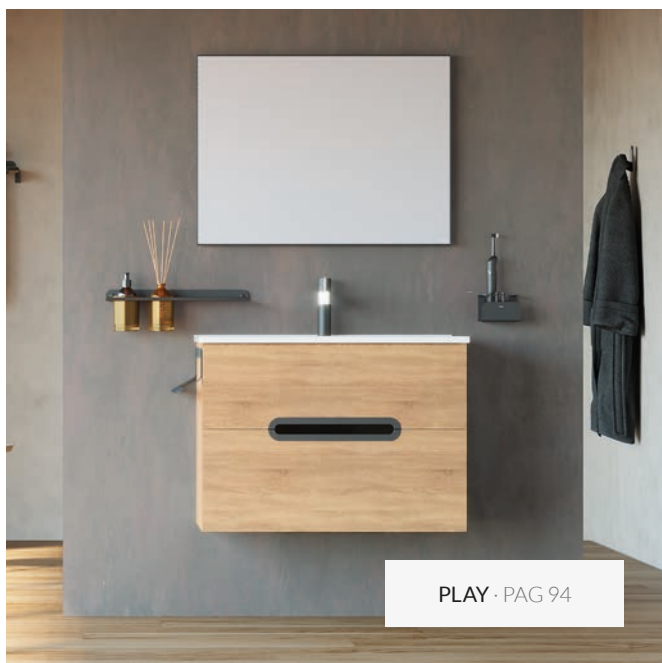

PLAY · PAG 94



PUZZLE · PAG 126



MIRRORS · PAG 136



LIGHTS · PAG 146



EVOLVE



EVOLVE



EVOLVE



EVOLVE





EVOLVE



EVOLVE



EVOLVE





EVOLVE



EVOLVE



EVOLVE





EVOLVE



EVOLVE







EVOLVE



EVOLVE



EVOLVE





EVOLVE





EVOLVE

MOST POPULARS



100CM COMBINATION

- Step 1 | Furniture
+ 187300 | 40 cm | Oak wood
+ 187485 | 60 cm | Blanco Soft
- Step 2 | Metal legs
+ 187812 | 100 cm | Black Matt
- Step 3 | Handles
+ 3 x 167135 | Evo | White
- Step 4 | Basin
+ 168583 | 100 cm | MX3 |
Mineral Solid (White Matt)



120CM COMBINATION

- Step 1 | Furniture
+ 187300 | 40 cm | Oak wood
+ 166909 | 20 cm | Anthracite Soft
+ 187553 | 60 cm | Anthracite Soft
- Step 2 | Metal legs
+ 187812 | 100 cm | Black Matte
- Step 3 | Handles
+ 3 x 181094 | Evo | Brushed Nickel
- Step 4 | Counter 120
+ 191888+(40-20-60:1Ø) | Marquina Stone
Basin
+ 188703 | 43x32 cm | Black Matte Ceramic



120CM COMBINATION

- Step 1 | Furniture
+ 187577 | 60 cm | Oakwood
+ 187577 | 60 cm | Oakwood
- Step 2 | Metallic legs
+ 187812 | 100 cm | Black Matte
- Step 3 | Handles
+ 4 x 187706 | Moon | Black
- Step 4 | Basin
+ 168613 | 120 cm | MX3 |
Mineral Solid (White Matt)

MOST POPULARS



140CM COMBINATION

- Step 1 | Furniture
+ 187485 | 60 cm | Blanco Soft
+ 165933 | 20 cm | Blanco Soft
+ 187485 | 60 cm | Blanco Soft
- Step 2 | Handles
+ 4 x 187720 | Moon | Brushed Gold
- Step 3 | Counter 140
+ 191772+(60:1Ø-20-60:1Ø) | Calacatta Stone
- Step 4 | Basin
+ 2 x 187331 | Ø37 | White Matt Ceramic



140CM COMBINATION:

- Step 1 | Furniture
+ 187546 | 60 cm | Blanco Soft
+ 165933 | 20 cm | Blanco Soft
+ 187546 | 60 cm | Blanco Soft
- Step 2 | Metallic legs
+ 188666 | 140 cm | Black
- Step 3 | Handles
+ 4 x 187706 | Moon | Black
- Step 4 | Counter 140
+ 191895+(60:1Ø-20-60:1Ø) | Marquina Stone
Basin
+ 2 x 187331 | Ø37 | White Matt Ceramic



HUMIDITY RESISTANCE
RESISTENTE A LA HUMEDAD



INSTALLATION TO THE WALL
INSTALACIÓN A PARED



MAX LOAD CAPACITY
CAPACIDAD MÁXIMA



DOUBLE LAYER PAINT
DOBLE CAPA PINTURA



3/4" (19mm) HDF THICKNESS
3/4" 19MM ESPESOR



SOFT CLOSE HARDWARE
CIERRE SUAVE



CRAFTSMANSHIP
HECHO A MANO



DRAWER ORGANIZER
CAJÓN ORGANIZADOR

| | SPECS ESPECIFICACIONES TÉCNICAS | BENEFITS BENEFICIOS |
|---|--|---|
| STRUCTURE ESTRUCTURA | <p>Thicknesses throughout the furniture of 19 mm. Particle board. HDF PVC edges 0.8 mm PUR technology (Reactive Polyurethane) Espesores de todo el mueble de 19 mm. Tablero partículas. HDF Cantos PVC 0.8 mm, tecnología PUR (Polyuretano reactivo).</p> | <p>Structure robustness. Humidity resistance. Estructura robusta. Resistente a la humedad.</p> |
| DRAWERS CAJONES + DOORS PUERTAS | <p>12 mm ultraslim anthracite metal drawer. Drawer depth 19 mm. Full extraction. Load capacity 30 Kg Organizers included. Regulation and adjustments front. Cajón metálico antracita ultra slim 12mm. Fondo cajón 19 mm. Extracción total. Capacidad carga 30 Kg. Organizadores incluidos. Regulación y ajuste frentes.</p> | <p>Design, order and cleanliness. Soft close. Capacity. Diseño, orden y limpieza. Suavidad apertura / cierre silencioso. Capacidad.</p> |
| HANDLES TIRADORES | <p>Materials: stainless steel, zamak, aluminium. Fishing technology: Anodized, PVD, electrolyc, thermosetting coating. Materiales: acero inoxidable, zamak, aluminio. Tecnología acabados: Anodizados, PVD, electrolíticos, recubrimiento termoendurecido.</p> | <p>Wide range of metallic finishes: brushed gold, brushed nickel, white and black. Resistance and durability. Amplia gama de acabados metálicos: oro cepillado, nickel cepillado, blanco y negro. Resistencia y durabilidad.</p> |
| INSTALLATION INSTALACIÓN | <p>Hangers + wall plate. Compliance with all regulations and standarts. Drain valves in faucet finishes: chrome, gold, white, black. Patented flexible siphon. Colgadores + placa de pared. Cumplimiento de todas las normativas y estandares. Válvulas desagüe en acabados grifería: cromo, oro, blanco, negro. Sifón flexible patentado.</p> | <p>Reliability, safety installation. Design and combination with other elements. Maximize drawer space. Reduces costs and facilitates plumbing installation. Fiabilidad, seguridad instalación. Diseño y combinación con el resto de elementos. Maximiza el espacio del cajón. Reduce costes y facilita la instalación de fontanería.</p> |
| LACQUERED FINISHES ACABADOS LACADOS | <p>Double layed paint on laminated fiber. Soft matte finishes. Doble capa de pintura sobre fibra laminada. Acabados mate soft.</p> | <p>No aging. It looks like the first day. Hardness and resistance lacquered surface. No envejece. Mantiene aspecto como el primer día. Dureza y resistencia de superficies lacadas.</p> |
| WOOD FINISHES ACABADOS MADERA | <p>Latest technology laminates with synchronized grain. Laminados última tecnología con veta sincronizada.</p> | <p>Ultra natural realism. They improve the resistance and properties of the natural veneer. Ultrarealismo natural. Mejoran la resistencia y las propiedades de la chapa natural.</p> |
| BASINS LAVABOS | <p>See features / washbasin range Ver características / gama lavabos</p> | |

EVOLVE

THE BEAUTY OF ART DECO



BASE UNIT MUEBLE

20 cm
40 cm
60 cm
70 cm



BLANCO SOFT



ANTHRACITE SOFT



OAK WOOD

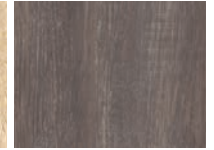

STORM WOOD

FINISHES ACABADOS



METAL LEGS (OPTIONAL) PATAS METÁLICAS (OPCIONAL)

100 cm
120 cm
140 cm



BLACK MATTE

FINISHES ACABADOS



HANDLES TIRADORES

Evo
Line
Moon



BRUSHED GOLD



BRUSHED NICKEL



WHITE



BLACK

FINISHES ACABADOS



BASIN LAVABOS

MX3
SX12 / 44x32
SX12 / Ø37



WHITE MATTE
CERAMIC



TORTORA MATTE
CERAMIC



DARK GREY MATTE
CERAMIC



BLACK MATTE
CERAMIC



MINERAL SOLID

FINISHES ACABADOS



COUNTER ENCIMERA

60cm
80cm
100cm
120cm
140cm

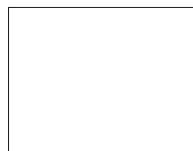

WHITE STONE

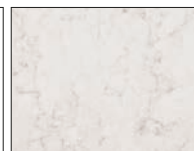

CALACATTA STONE



POLAR STONE

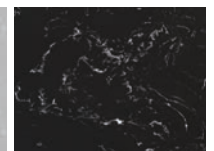

MARQUINA STONE

FINISHES ACABADOS

EVOLVE

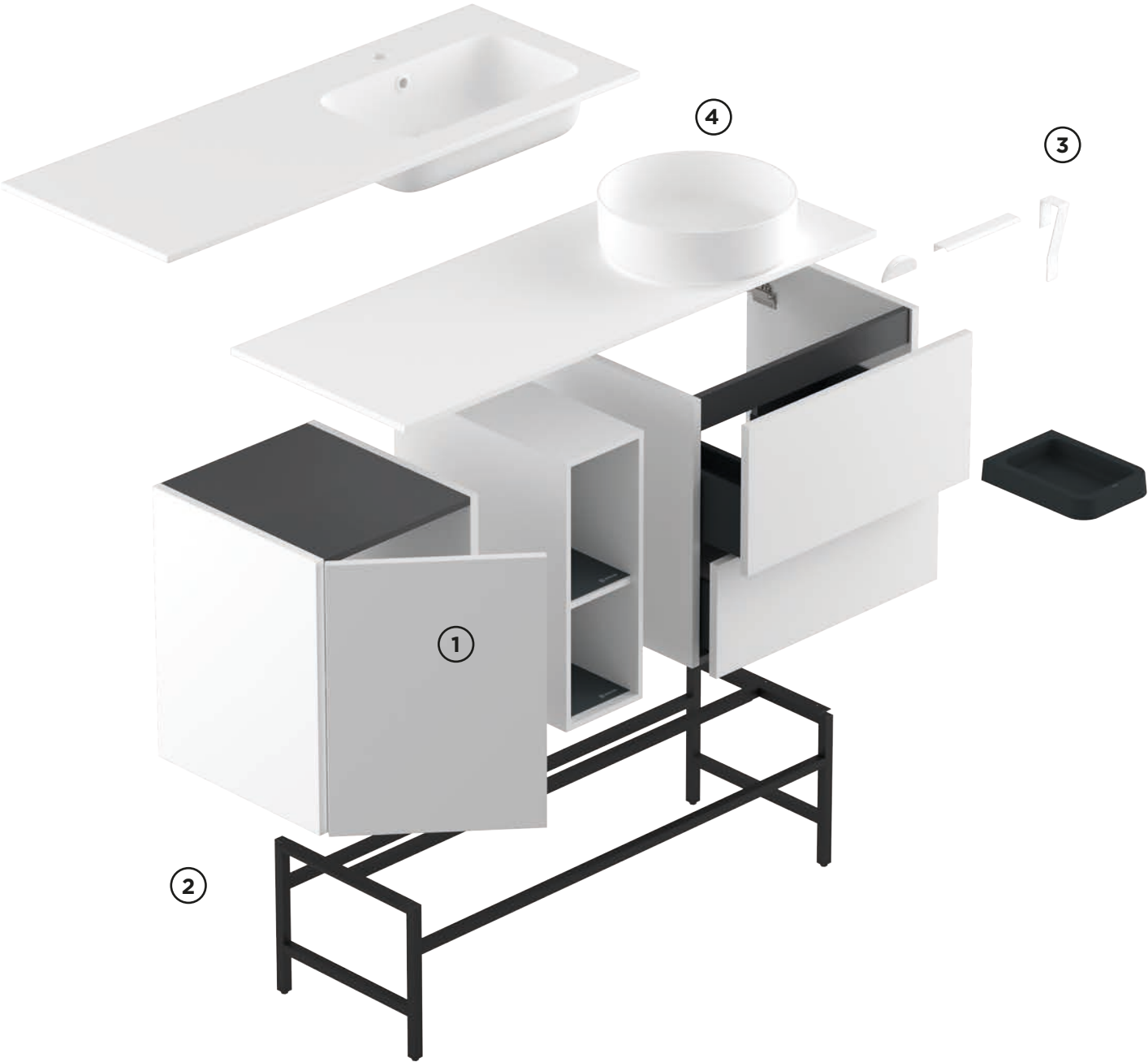

CREATE YOUR EVOLVE CREA TU EVOLVE

STEP 1

SELECT BASE UNITS COMBINATION

SELECCIONA LA COMBINACIÓN DEL ARMAZÓN

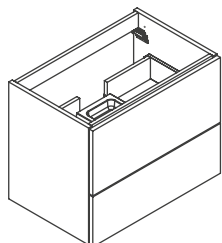

70 cm (28")

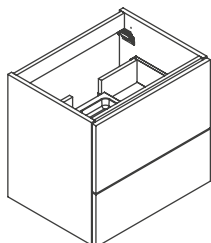

60 cm (24")

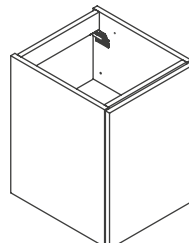

40 cm (16")

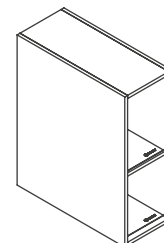

20 cm (8")

STEP 2

SELECT THE METAL LEGS

SELECCIONA LAS PATAS METÁLICAS

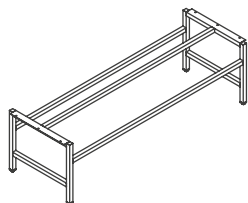

100 cm | 120 cm | 140 cm
40" | 48" | 56"

STEP 3

SELECT THE SET OF HANDLES

SELECCIONA EL SET DE TIRADORES



EVO

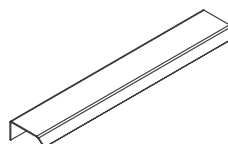

LINE

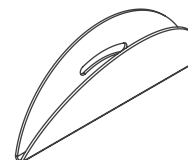

MOON

STEP 4

SELECT THE BASIN

SELECCIONA EL LAVABO

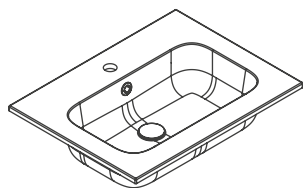

MX3

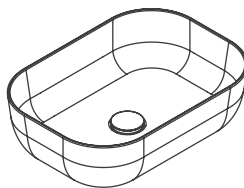

SX12/44x32

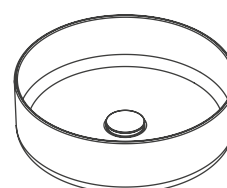

SX12/Ø37

STEP 5

SELECT THE COUNTERTOP

SELECCIONA EL LAVABO

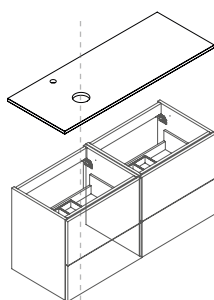

24" + 24"
60 cm + 60 cm

LEFT
IZQUIERDA

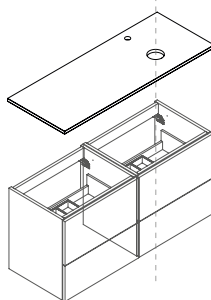

24" + 24"
60 cm + 60 cm

RIGHT
DERECHA

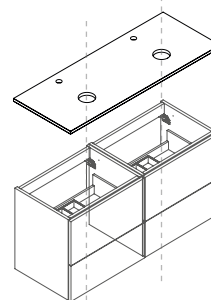

24" + 24"
60 cm + 60 cm

DOUBLE
DOBLE

EVOLVE



BASE UNIT FINISH OPTIONS OPCIONES DE ACABADOS ARMAZÓN

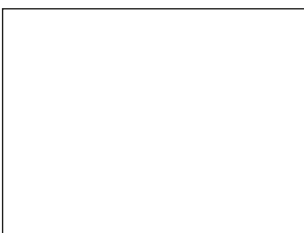

BLANCO SOFT
Ref. 99922240



ANTHRACITE SOFT
Ref. 9992225R

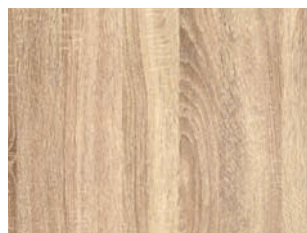

OAK WOOD
Ref. 9992225G

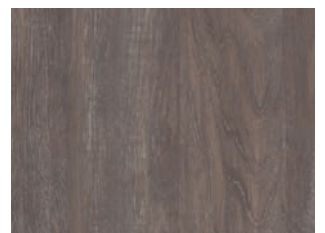

STORM WOOD
Ref. 9992226B

STEP 1
BASE UNIT
ARMAZÓN

STEP 2
METAL LEGS
PATAS METÁLICAS

STEP 3
HANDLES
TIRADORES

STEP 4
COUNTER / ENCIMERA
BASIN / LAVABO

STEP 1 - SELECT THE BASE UNIT
STEP 1 - SELECCIONA EL ARMAZÓN

70 CM TWO DRAWERS BASE UNIT (28")
ARMAZÓN DOS CAJONES 70 CM (28")

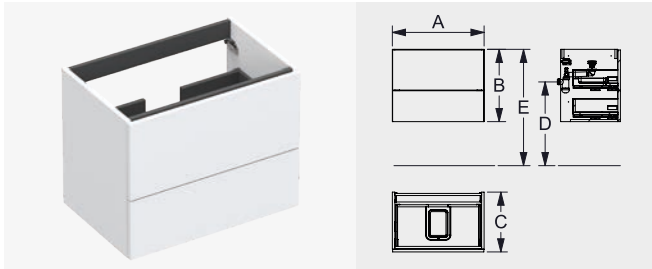

BLANCO SOFT
ANTHRACITE SOFT
OAKWOOD
STORMWOOD

Ref. 181636
Ref. 181612
Ref. 187577
Ref. 187591

A: 698 mm. B: 550 mm. C: 455 mm.
D: 637 mm. E: 885 mm.

60 CM TWO DRAWERS BASE UNIT (24")
ARMAZÓN DOS CAJONES 60 CM (24")

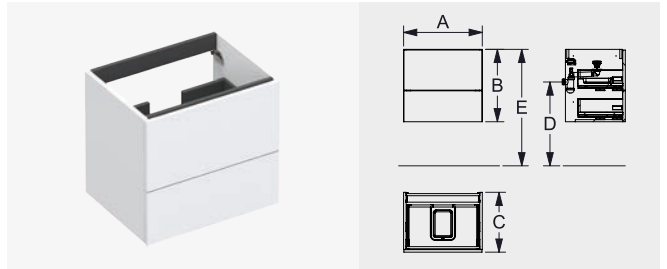

BLANCO SOFT
ANTHRACITE SOFT
OAKWOOD
STORMWOOD

Ref. 187485
Ref. 170555
Ref. 187515
Ref. 187539

A: 598 mm. B: 550 mm. C: 455 mm.
D: 637 mm. E: 885 mm.

40 CM DOOR BASE UNIT (16")
ARMAZÓN PUERTA 40 CM (16")

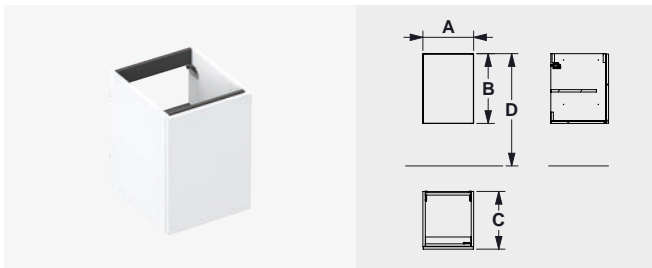

BLANCO SOFT
ANTHRACITE SOFT
OAKWOOD
STORMWOOD

Ref. 166930
Ref. 166954
Ref. 187300
Ref. 187324

A: 398 mm. B: 550 mm.
C: 455 mm. D: 885 mm.

20 CM BASE UNIT (8")
ARMAZÓN 20 CM (8")

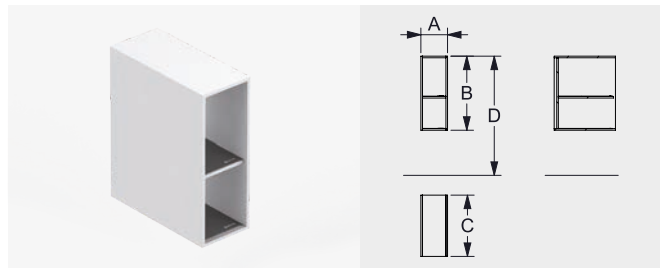

BLANCO SOFT
ANTHRACITE SOFT

Ref. 165933
Ref. 166909

A: 198 mm. B: 550 mm.
C: 455 mm. D: 885 mm.

Reversible doors. Choose right or left opening.
Puertas reversibles. Elije apertura derecha o izquierda.

120 CM WALL VITRINE (47")
COLUMNA 120 CM (47")



BLANCO SOFT
ANTHRACITE SOFT
OAKWOOD
STORMWOOD

Ref. 188161
Ref. 189588
Ref. 172702
Ref. 187256

A: 350 mm. B: 1200 mm. C: 261 mm.

CREATE YOUR EVOLVE / CREA TU EVOLVE

STEP 1
BASE UNIT
ARMAZÓN

STEP 2
METAL LEGS
PATAS METÁLICAS

STEP 3
HANDLES
TIRADORES

STEP 4
COUNTER / ENCIMERA
BASIN / LAVABO

STEP 2 - SELECT THE LEG (OPTIONAL)
STEP 2 - SELECCIONA LAS PATAS (OPCIONAL)

BALCK METAL LEGS
ESTRUCTURA PATAS METÁLICAS NEGRAS

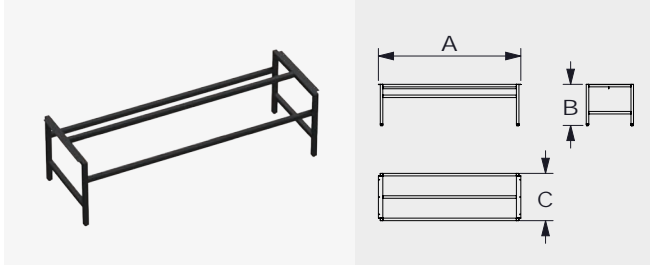

A = 1000 mm
A = 1200 mm
A = 1400 mm

Ref. 187812
Ref. 188642
Ref. 188666

B: 326 mm. C: 375 mm.

METAL LEGS FINISH OPTIONS
OPCIONES DE ACABADO DE LA ESTRUCTURA DE PATAS



BLACK MATTE



STEP 1
BASE UNIT
ARMAZÓN

STEP 2
METAL LEGS
PATAS METÁLICAS

STEP 3
HANDLES
TIRADORES

STEP 4
COUNTER / ENCIMERA
BASIN / LAVABO

STEP 3 - SELECT THE HANDLES
STEP 3 - SELECCIONA LOS TIRADORES

EVO HANDLE
TIRADOR EVO

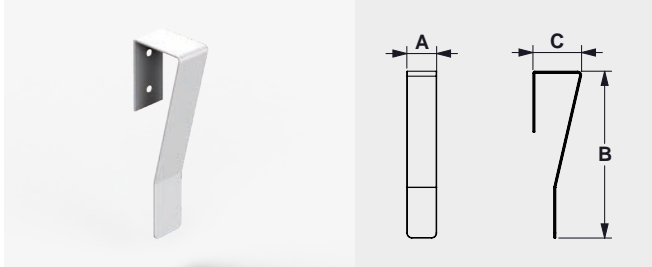

WHITE
BLACK
BRUSHED NICKEL
BRUSHED GOLD

Ref. 167135
Ref. 186198
Ref. 181094
Ref. 181100

A: 30 mm. B: 165 mm. C: 50 mm.

LINE HANDLE
TIRADOR LINE

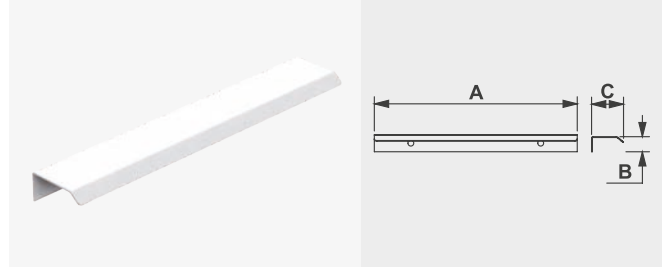

WHITE
BLACK
BRUSHED NICKEL

Ref. 167197
Ref. 189335
Ref. 191918

A: 198 mm. B: 7 mm. C: 20 mm.

MOON HANDLE
TIRADOR MOON

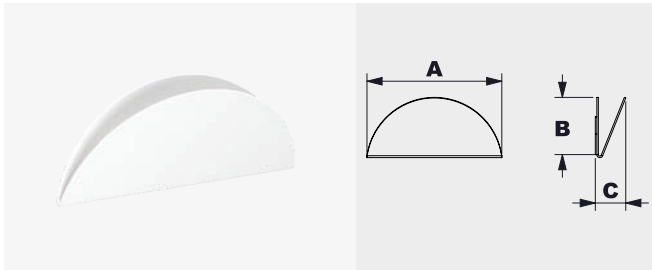

WHITE
BLACK
BRUSHED NICKEL
BRUSHED GOLD

Ref. 187690
Ref. 187706
Ref. 187713
Ref. 187720

A: 90 mm. B: 38 mm. C: 21 mm.

HANDLES FINISH OPTIONS
OPCIONES DE ACABADO DE LOS TIRADORES



WHITE



BRUSHED NICKEL



BLACK



BRUSHED GOLD

EVOLVE

MX3



FINISH COUNTER
ACABADO LAVABO

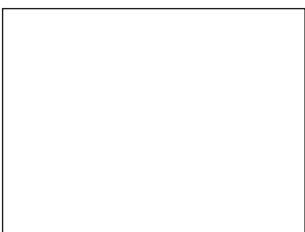

WHITE MINERAL SOLID

STEP 1
BASE UNIT
ARMAZÓN

STEP 2
METAL LEGS
PATAS METÁLICAS

STEP 3
HANDLES
TIRADORES

STEP 4
COUNTER / ENCIMERA
BASIN / LAVABO

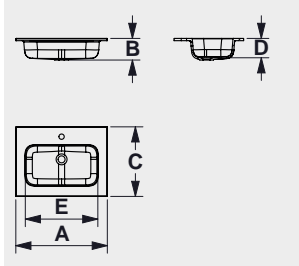

A: 605 mm. B: 143 mm. C: 460 mm.
D: 128 mm. E: 480 mm.



Clicker not included
Clicker no incluido

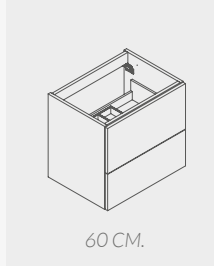

60 CM MX3 BASIN 1Ø (24")
LAVABO MX3 60 CM 1Ø (24")

MINERAL SOLID Ref. 168545

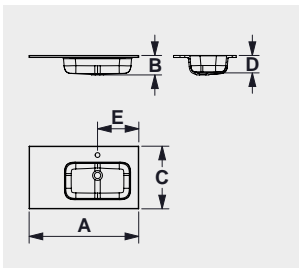

A: 805 mm. B: 143 mm. C: 460 mm.
D: 120 mm. E: 300 mm.



Clicker not included
Clicker no incluido

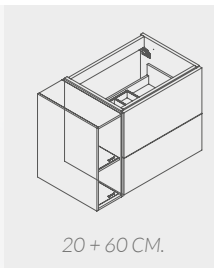

80 CM MX3 BASIN 1Ø OFFSET RIGHT (32")
LAVABO MX3 80 CM 1Ø DCHA. (32")

MINERAL SOLID Ref. 168569

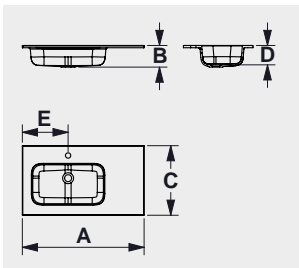

A: 805 mm. B: 143 mm. C: 460 mm.
D: 128 mm. E: 300 mm.



Clicker not included
Clicker no incluido

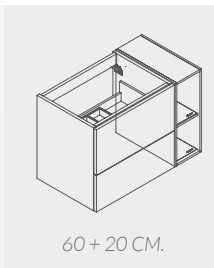

80 CM MX3 BASIN 1Ø OFFSET LEFT (32")
LAVABO MX3 80 CM 1Ø IZDA. (32")

MINERAL SOLID Ref. 168552

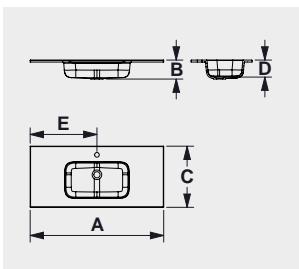

A: 1005 mm. B: 143 mm. C: 460 mm.
D: 128 mm. E: 502,5 mm.



Clicker not included
Clicker no incluido

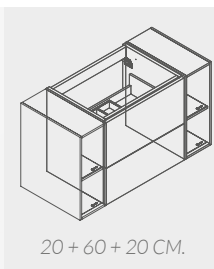

100 CM MX3 BASIN 1Ø (40")
LAVABO MX3 100 CM 1Ø (40")

MINERAL SOLID Ref. 168897

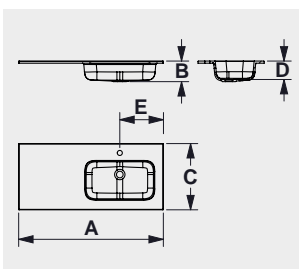

A: 1005 mm. B: 143 mm. C: 460 mm.
D: 128 mm. E: 300 mm.



Clicker not included
Clicker no incluido

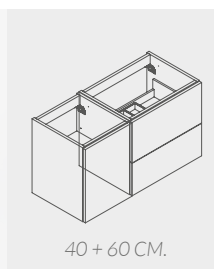

100 CM MX3 BASIN 1Ø OFFSET RIGHT (40")
LAVABO MX3 100 CM 1Ø DCHA. (40")

MINERAL SOLID Ref. 168583

CREATE YOUR EVOLVE

STEP 1
BASE UNIT
ARMAZÓN

STEP 2
METAL LEGS
PATAS METÁLICAS

STEP 3
HANDLES
TIRADORES

STEP 4
COUNTER / ENCIMERA
BASIN / LAVABO

100 CM MX3 BASIN 1Ø OFFSET LEFT (40")
LAVABO MX3 100 CM 1Ø IZDA. (40")

MINERAL SOLID Ref. 168576

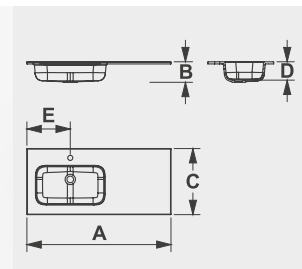
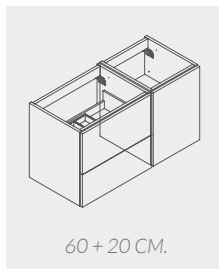

Clicker not included
Clicker no incluido
A: 1005 mm. B: 143 mm. C: 460 mm.
D: 128 mm. E: 300 mm.

120 CM MX3 BASIN 1Ø DOUBLE (48")
LAVABO MX3 120 CM 1Ø DOBLE (48")

MINERAL SOLID Ref. 168613

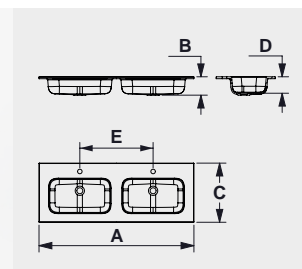
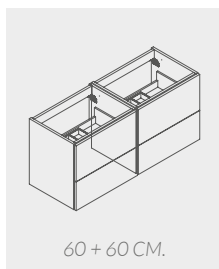

Clicker not included
Clicker no incluido
A: 1205 mm. B: 143 mm. C: 460 mm.
D: 128 mm. E: 570 mm.

120 CM MX3 BASIN 1Ø OFFSET RIGHT (48")
LAVABO MX3 120 CM 1Ø DCHA. (48")

MINERAL SOLID Ref. 168606

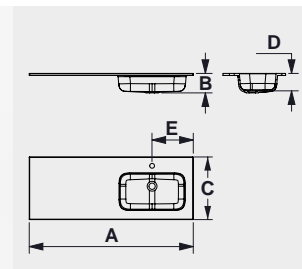
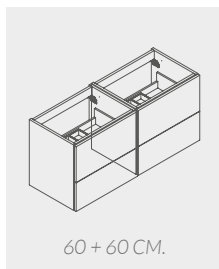

Clicker not included
Clicker no incluido
A: 1205 mm. B: 143 mm. C: 460 mm.
D: 128 mm. E: 300 mm.

120 CM MX3 BASIN 1Ø OFFSET LEFT (48")
LAVABO MX3 120 CM 1Ø IZDA. (48")

MINERAL SOLID Ref. 168590

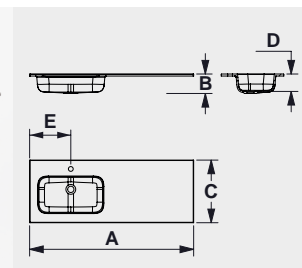
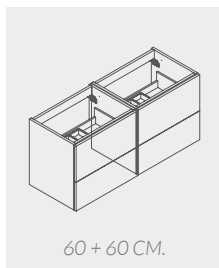

Clicker not included
Clicker no incluido
A: 1205 mm. B: 143 mm. C: 460 mm.
D: 128 mm. E: 300 mm.

STEP 1
BASE UNIT
ARMAZÓN

STEP 2
METAL LEGS
PATAS METÁLICAS

STEP 3
HANDLES
TIRADORES

STEP 4
COUNTER / ENCIMERA
BASIN / LAVABO

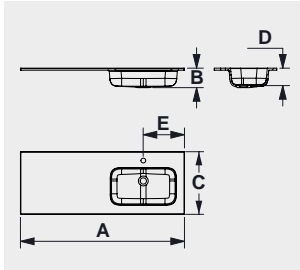

A: 1205 mm. B: 143 mm. C: 460 mm.
D: 128 mm. E: 300 mm.



Clicker not included
Clicker no incluido



240 + 20 + 60 CM.

120 CM MX3 BASIN 1Ø OFFSET RIGHT (48")
LAVABO MX3 120 1Ø DCHA. (48")

MINERAL SOLID Ref. 168506

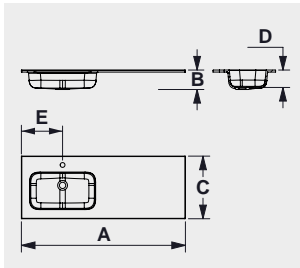

A: 1205 mm B: 143 mm C: 460 mm
D: 128 mm E: 300 mm



Clicker not included
Clicker no incluido



60 + 20 + 40 CM.

120 CM MX3 BASIN 1Ø OFFSET LEFT (48")
LAVABO MX3 120 CM 1Ø IZDA. (48")

MINERAL SOLID Ref. 168590

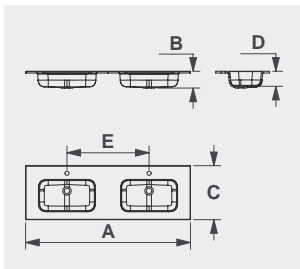

A: 1405 mm B: 143 mm C: 460 mm
D: 128 mm E: 700 mm



Clicker not included
Clicker no incluido

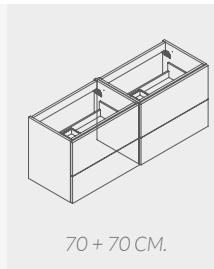

70 + 70 CM.

140 CM MX3 BASIN 1Ø DOUBLE (56")
LAVABO MX3 140 CM 1Ø DOBLE (56")

MINERAL SOLID Ref. 176106

COMPLETE YOUR INSTALLATION
COMPLETA TU INSTALACIÓN

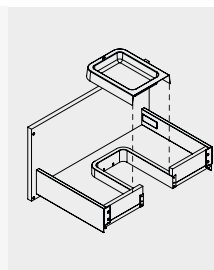
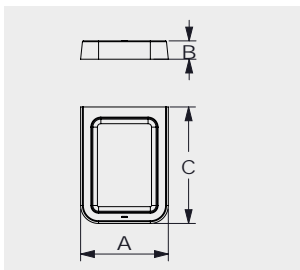

TRAP COVER TRAY
BANDEJA CUBRE SIFÓN

GRAPHITE Ref. 190126
WHITE / BLANCO Ref. 190119



PRELOC + CLICKER
TRAP 1 1/4" + VALVE
SIFÓN 1 1/4" + VÁLVULA

CLICKER CHROME Ref. 161508
CLICKER WHITE Ref. 190102

EVOLVE



SX12 BASIN - FINISHES ACABADOS LAVABOS SX12



WHITE MATT CERAMIC



TORTORA MATT CERAMIC

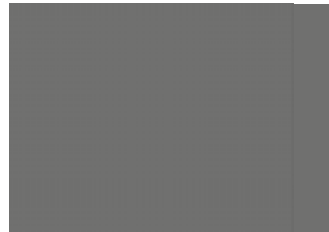

DARK GREY MATT CERAMIC



BLACK MATT CERAMIC

COMPACT COUNTER - FINISHES ACABADOS ENCIMERA COMPACTA

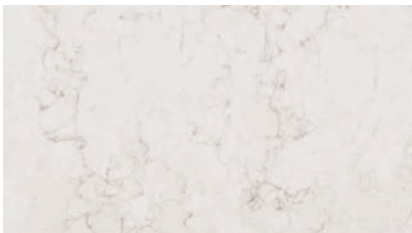

CALACATTA STONE



POLAR STONE

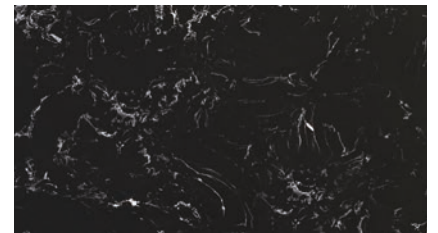

MARQUINA STONE

MICROTECH COUNTER FINISHES ACABADOS ENCIMERA MICROTECH



WHITE STONE

STEP 1
BASE UNIT
ARMAZÓN

STEP 2
METAL LEGS
PATAS METÁLICAS

STEP 3
HANDLES
TIRADORES

STEP 4
COUNTER / ENCIMERA
BASIN / LAVABO

OPTIONS BASIN + COUNTERTOP
OPCIONES LAVABO + ENCIMERA

Example: counter 120 cm.
Ejemplo: encimera 120 cm.

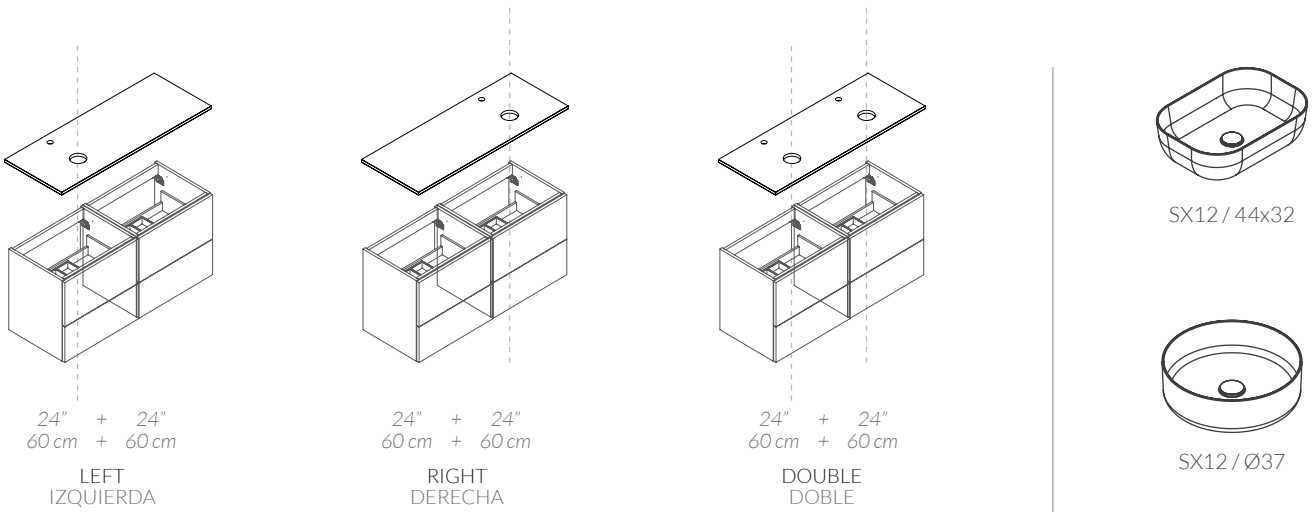

- Step 1 | Furniture 120 cm Armazón 120 cm
Paso 1 | + 187300 | 40 cm | Oakwood
+ 166909 | 20 cm | Anthracite Soft
+ 187553 | 60 cm | Anthracite Soft
- Step 2 | Metal Legs Patas metálicas
Paso 2 | + 187812 | 120 cm | Black Matte
- Step 3 | Handles Tiradores
Paso 3 | + 3 x 181094 | Evo | Brushed Nickel
- Step 4 | Counter Encimera
Paso 4 | + 189243 (40-20-60:10) | Marquina Stone
Basin Lavabo
+ 188703 | 43x32 cm | Black Matte Ceramic

- Step 1 | Furniture 140 cm Armazón 140 cm
Paso 1 | + 187546 | 60 cm | Blanco soft
+ 165933 | 20 cm | Blanco soft
+ 187546 | 60 cm | Blanco soft
- Step 2 | Metal Legs Patas metálicas
Paso 2 | + 188666 | 140 cm | Black Matte
- Step 3 | Handles Tiradores
Paso 3 | + 4 x 187706 | Moon | Black
- Step 4 | Counter Encimera
Paso 4 | + 189106 | Marquina Stone
Basin Lavabo
+ 2 x 187331 | Ø37 | White Matt Ceramic

STEP 1
BASE UNIT
ARMAZÓN

STEP 2
METAL LEGS
PATAS METÁLICAS

STEP 3
HANDLES
TIRADORES

STEP 4
COUNTER / ENCIMERA
BASIN / LAVABO

STEP 4 - SELECT THE BASIN AND COUNTER
STEP 4 - ESCOGE EL LAVABO Y ENCIMERA

SX12 BASIN CERAMIC 44x32
SX12 LAVABO CERÁMICA 44x32

WHITE MATT CERAMIC Ref. 187362
TORTORA MATT CERAMIC Ref. 187379
DARK GREY MATT CERAMIC Ref. 187386
BLACK MATT CERAMIC Ref. 188703



A: 455 mm. B: 135 mm. C: 325 mm. D: 109 mm.
*Clicker not included

SX12 BASIN CERAMIC Ø37
SX12 LAVABO CERÁMICA Ø37

WHITE MATT CERAMIC Ref. 187331
TORTORA MATT CERAMIC Ref. 187348
DARK GREY MATT CERAMIC Ref. 187355
BLACK MATT CERAMIC Ref. 188697



A: 370 mm. B: 120 mm. D: 91 mm.
*Clicker not included

COMPLETE YOUR INSTALLATION
COMPLETA TU INSTALACIÓN

TRAP COVER TRAY
BANDEJA CUBRE SIFÓN

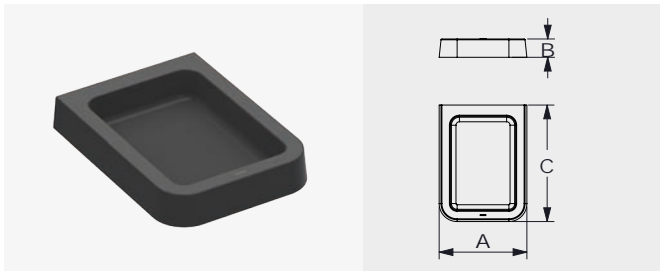

GRAPHITE
WHITE / BLANCO

Ref. 190126
Ref. 190119

A: 192 mm. B: 40 mm. C: 255 mm.

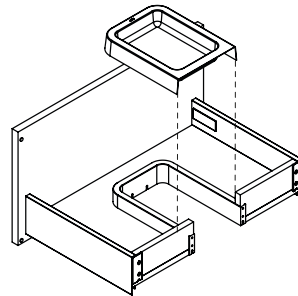

TRAP
WASTEP-TRAP 1 1/4"

CHROME

Ref. 097388



CLICKER
PUSH DOWN
Ø 65 MM 1 1/4"
CHROME
WHITE
BLACK
TORTORA
DARK GREY

Ref. 123940
Ref. 188895
Ref. 188888
Ref. 188901
Ref. 188918



PRELOC + CLICKER
TRAP 1 1/4"
SIFÓN 1 1/4"
CLICKER CHROME
CLICKER WHITE

Ref. 161508
Ref. 190102

STEP 1
BASE UNIT
ARMAZÓN

STEP 2
METAL LEGS
PATAS METÁLICAS

STEP 3
HANDLES
TIRADORES

STEP 4
COUNTER / ENCIMERA
BASIN / LAVABO

60 CM COMBINATIONS (24")
COMBINACIONES 60 CM (24")



COMPACT COUNTER 1Ø
COMPACT ENCIMERA 1Ø

CALACATTA STONE Ref. 188925
POLAR STONE Ref. 195923
MARQUINA STONE Ref. 188932

MICROTECH COUNTER 1Ø
MICROTECH ENCIMERA 1Ø

WHITE STONE Ref. 188109

COMPACT = A: 605 mm. B: 20 mm. C: 460 mm.
MICROTECH = A: 605 mm. B: 15 mm. C: 460 mm.

70 CM COMBINATIONS (24")
COMBINACIONES 70 CM (24")



COMPACT COUNTER 0Ø
COMPACT ENCIMERA 0Ø

CALACATTA STONE Ref. 188949
POLAR STONE Ref. 195930
MARQUINA STONE Ref. 188956

MICROTECH COUNTER 0Ø
MICROTECH ENCIMERA 0Ø

WHITE STONE Ref. 188710

COMPACT = A: 605 mm. B: 20 mm. C: 460 mm.
MICROTECH = A: 605 mm. B: 15 mm. C: 460 mm.

80 CM COMBINATIONS (32")
COMBINACIONES 80 CM (32")



COMPACT COUNTER 1Ø
COMPACT ENCIMERA 1Ø

CALACATTA STONE Ref. 188963
POLAR STONE Ref. 195947
MARQUINA STONE Ref. 188970

MICROTECH COUNTER 1Ø
MICROTECH ENCIMERA 1Ø

WHITE STONE Ref. 189342

COMPACT = A: 805 mm. B: 20 mm. C: 460 mm. D: 300 mm.
MICROTECH = A: 805 mm. B: 15 mm. C: 460 mm. D: 300 mm.



COMPACT COUNTER 1Ø
COMPACT ENCIMERA 1Ø

CALACATTA STONE Ref. 189151
POLAR STONE Ref. 195954
MARQUINA STONE Ref. 189168

MICROTECH COUNTER 0Ø
MICROTECH ENCIMERA 1Ø

WHITE STONE Ref. 189410

COMPACT = A: 805 mm. B: 20 mm. C: 460 mm. D: 300 mm.
MICROTECH = A: 805 mm. B: 15 mm. C: 460 mm. D: 300 mm.

STEP 1
BASE UNIT
ARMAZÓN

STEP 2
METAL LEGS
PATAS METÁLICAS

STEP 3
HANDLES
TIRADORES

STEP 4
COUNTER / ENCIMERA
BASIN / LAVABO

100 CM COMBINATIONS (40")
COMBINACIONES 100 CM (40")

COMPACT COUNTER 1Ø
COMPACT ENCIMERA 1Ø

CALACATTA STONE Ref. 195978
POLAR STONE Ref. 195961
MARQUINA STONE Ref. 195985

MICROTECH COUNTER 1Ø
MICROTECH ENCIMERA 1Ø

WHITE STONE Ref. 187409



COMPACT = A: 1005 mm. B: 20 mm. C: 460 mm.
MICROTECH = A: 1005 mm. B: 15 mm. C: 460 mm.

COMPACT COUNTER 1Ø
COMPACT ENCIMERA 1Ø

CALACATTA STONE Ref. 189007
POLAR STONE Ref. 195992
MARQUINA STONE Ref. 187805

MICROTECH COUNTER 0Ø
MICROTECH ENCIMERA 1Ø

WHITE STONE Ref. 189359



COMPACT = A: 1005 mm. B: 20 mm. C: 460 mm. D: 300 mm.
MICROTECH = A: 1005 mm. B: 15 mm. C: 460 mm. D: 300 mm.

COMPACT COUNTER 1Ø
COMPACT ENCIMERA 1Ø

CALACATTA STONE Ref. 189199
POLAR STONE Ref. 196005
MARQUINA STONE Ref. 189205

MICROTECH COUNTER 1Ø
MICROTECH ENCIMERA 1Ø

WHITE STONE Ref. 189434



COMPACT = A: 605 mm. B: 20 mm. C: 460 mm. D: 300 mm.
MICROTECH = A: 605 mm. B: 15 mm. C: 460 mm. D: 300 mm.

STEP 1
BASE UNIT
ARMAZÓN

STEP 2
METAL LEGS
PATAS METÁLICAS

STEP 3
HANDLES
TIRADORES

STEP 4
COUNTER / ENCIMERA
BASIN / LAVABO

120 CM COMBINATIONS (48")
COMBINACIONES 120 CM (48")

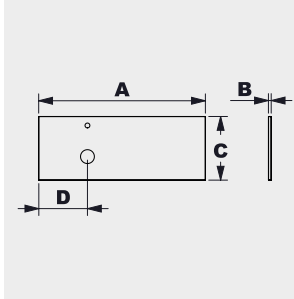

A-LEFT
A-IZQUIERDA

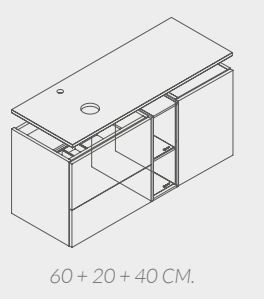

COMPACT COUNTER 1Ø
COMPACT ENCIMERA 1Ø

CALACATTA STONE Ref. 189038
POLAR STONE Ref. 196012
MARQUINA STONE Ref. 189045

MICROTECH COUNTER 1Ø
MICROTECH ENCIMERA 1Ø

WHITE STONE Ref. 189373

COMPACT = A: 1205 mm. B: 20 mm. C: 460 mm. D: 300 mm.
MICROTECH = A: 1205 mm. B: 15 mm. C: 460 mm. D: 300 mm.

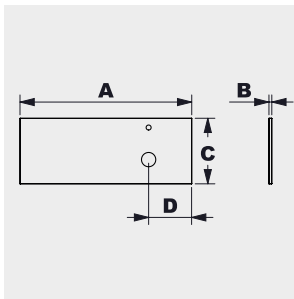

A-RIGHT
A-DERECHA

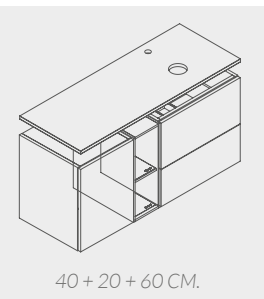

COMPACT COUNTER 1Ø
COMPACT ENCIMERA 1Ø

CALACATTA STONE Ref. 189236
POLAR STONE Ref. 196029
MARQUINA STONE Ref. 189243

MICROTECH COUNTER 0Ø
MICROTECH ENCIMERA 1Ø

WHITE STONE Ref. 189441

COMPACT = A: 1205 mm. B: 20 mm. C: 460 mm. D: 300 mm.
MICROTECH = A: 1205 mm. B: 15 mm. C: 460 mm. D: 300 mm.

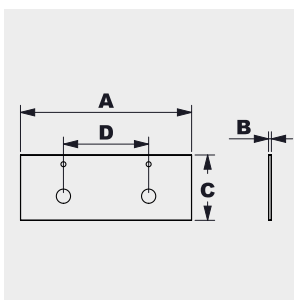

A-DOUBLE
A-DOBLE

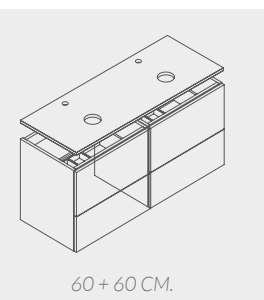

COMPACT COUNTER 2Ø
COMPACT ENCIMERA 2Ø

CALACATTA STONE Ref. 189502
POLAR STONE Ref. 196036
MARQUINA STONE Ref. 189519

MICROTECH COUNTER 2Ø
MICROTECH ENCIMERA 2Ø

WHITE STONE Ref. 188741

COMPACT = A: 1205 mm. B: 20 mm. C: 460 mm. D: 600 mm.
MICROTECH = A: 1205 mm. B: 15 mm. C: 460 mm. D: 600 mm.

STEP 1
BASE UNIT
ARMAZÓN

STEP 2
METAL LEGS
PATAS METÁLICAS

STEP 3
HANDLES
TIRADORES

STEP 4
COUNTER / ENCIMERA
BASIN / LAVABO

140 CM COMBINATIONS (56")
COMBINACIONES 140 (56")

COMPACT COUNTER 1Ø
COMPACT ENCIMERA 1Ø

CALACATTA STONE Ref. 189076
POLAR STONE Ref. 196043
MARQUINA STONE Ref. 189083

MICROTECH COUNTER 1Ø
MICROTECH ENCIMERA 1Ø

WHITE STONE Ref. 189380

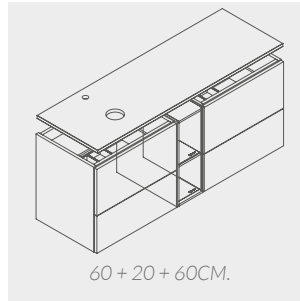

A-LEFT
A-IZQUIERDA

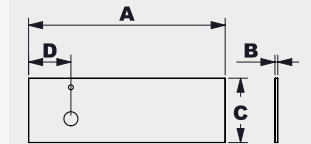

COMPACT = A: 1405 mm. B: 20 mm. C: 460 mm. D: 350 mm.
MICROTECH = A: 1405 mm. B: 15 mm. C: 460 mm. D: 350 mm.

COMPACT COUNTER 1Ø
COMPACT ENCIMERA 1Ø

CALACATTA STONE Ref. 189274
POLAR STONE Ref. 196050
MARQUINA STONE Ref. 189281

MICROTECH COUNTER 0Ø
MICROTECH ENCIMERA 0Ø

WHITE STONE Ref. 189465

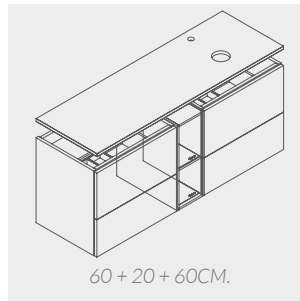

A-RIGHT
A-DERECHA

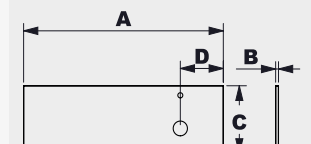

COMPACT = A: 1405 mm. B: 20 mm. C: 460 mm. D: 350 mm.
MICROTECH = A: 1405 mm. B: 15 mm. C: 460 mm. D: 350 mm.

COMPACT COUNTER DOUBLE 2Ø
COMPACT ENCIMERA DOBLE 2Ø

CALACATTA STONE Ref. 189090
POLAR STONE Ref. 196067
MARQUINA STONE Ref. 189106

MICROTECH COUNTER DOUBLE 2Ø
MICROTECH ENCIMERA DOBLE 2Ø

WHITE STONE Ref. 189403

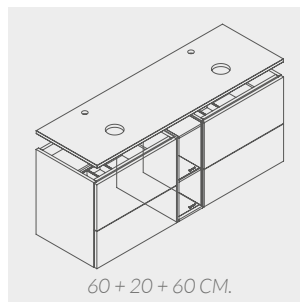

A-DOUBLE
A-DOBLE

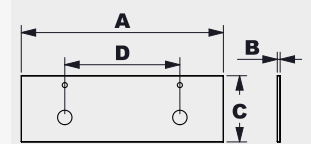

COMPACT = A: 1405 mm. B: 20 mm. C: 460 mm. D: 700 mm.
MICROTECH = A: 1405 mm. B: 15 mm. C: 460 mm. D: 700 mm.

STEP 1
BASE UNIT
ARMAZÓN

STEP 2
METAL LEGS
PATAS METÁLICAS

STEP 3
HANDLES
TIRADORES

STEP 4
COUNTER / ENCIMERA
BASIN / LAVABO

140 CM COMBINATIONS (56")
COMBINACIONES 140 (56")



COMPACT = A: 1405 mm. B: 20 mm. C: 460 mm. D: 350 mm.
MICROTECH = A: 1405 mm. B: 15 mm. C: 460 mm. D: 350 mm.

COMPACT COUNTER 1Ø
COMPACT ENCIMERA 1Ø

CALACATTA STONE Ref. 196081
POLAR STONE Ref. 196104
MARQUINA STONE Ref. 196098

MICROTECH COUNTER 1Ø
MICROTECH ENCIMERA 1Ø

WHITE STONE Ref. 196180



COMPACT = A: 1405 mm. B: 20 mm. C: 460 mm. D: 350 mm.
MICROTECH = A: 1405 mm. B: 15 mm. C: 460 mm. D: 350 mm.

COMPACT COUNTER 1Ø
COMPACT ENCIMERA 1Ø

CALACATTA STONE Ref. 196111
POLAR STONE Ref. 196135
MARQUINA STONE Ref. 196128

MICROTECH COUNTER 1Ø
MICROTECH ENCIMERA 1Ø

WHITE STONE Ref. 196197



COMPACT = A: 1405 mm. B: 20 mm. C: 460 mm. D: 700 mm.
MICROTECH = A: 1405 mm. B: 15 mm. C: 460 mm. D: 700 mm.

COMPACT COUNTER DOUBLE 2Ø
COMPACT ENCIMERA DOBLE 2Ø

CALACATTA STONE Ref. 189298
POLAR STONE Ref. 196074
MARQUINA STONE Ref. 189304

MICROTECH COUNTER DOUBLE 2Ø
MICROTECH ENCIMERA DOBLE 2Ø

WHITE STONE Ref. 189403



ÉPOQUE



ÉPOQUE





ÉPOQUE



ÉPOQUE



ÉPOQUE





ÉPOQUE



ÉPOQUE



ÉPOQUE



ÉPOQUE





HUMIDITY RESISTANCE
RESISTENTE A LA HUMEDAD



INSTALLATION NOT REQUIRED
SIN INSTALACIÓN



MAX LOAD CAPACITY
CAPACIDAD MÁXIMA



DOUBLE LAYER PAINT
DOBLE CAPA PINTURA



3/4" (19mm) HDF THICKNESS
3/4" 19MM ESPESOR



SOFT CLOSE HARDWARE
CIERRE SUAVE



CRAFTSMANSHIP
HECHO A MANO



DRAWER ORGANIZER
CAJÓN ORGANIZADOR

| | ESPECS ESPECIFICACIONES TÉCNICAS | BENEFITS BENEFICIOS |
|--|---|---|
| STRUCTURE ESTRUCTURA | <p>Thicknesses throughout the furniture of 19 mm. Particle board. HDF PVC edges 0.8 mm PUR technology (Reactive Polyurethane) Espesores de todo el mueble de 19 mm. Tablero partículas. HDF Cantos PVC 0.8 mm, tecnología PUR (Polyuretano reactivo).</p> | <p>Structure robustness. Humidity resistance. Robustez estructura. Resistente a la humedad.</p> |
| DRAWERS CAJONES | <p>12 mm ultraslim anthracite metal drawer. Drawer depth 19 mm. Full extraction. Load capacity 30 Kg Organizers included. Regulation and adjustments front. Materials: stainless steel, zamak, aluminium. Fishing technology: Anodized, PVD, electrolyc, thermosetting coating. Cajón metálico antracita ultra slim 12mm. Fondo cajón 19 mm. Extracción total. Capacidad carga 30 Kg. Organizadores incluidos. Regulación y ajuste frentes. Materiales: acero inoxidable, zamak, aluminio. Tecnología acabados: Anodizados, PVD, electrolíticos, recubrimiento termoendurecido.</p> | <p>Design, order and cleanliness. Soft close. Capacity. Wide range of metallic finishes. Resistance and durability. Diseño, orden y limpieza. Suavidad apertura / cierre silencioso. Capacidad. Amplia gama de acabados metálicos. Resistencia y durabilidad.</p> |
| INSTALLATION INSTALACIÓN | <p>Hangers + wall plate made Italy. Compliance with all regulations and standarts. Drain valves in faucet finishes: chrome, gold, white, black. Patented flexible siphon. Colgadores + placa de pared hecha en Italia. Cumplimiento de todas las normativas y estandares. Válvulas desagüe en acabados grifería: cromo, oro, blanco, negro. Sifón flexible patentado.</p> | <p>Reliability, safety installation. Design and combination with other elements. Maximize drawer space. Reduces costs and facilitates plumbing installation. Fiabilidad, seguridad instalación. Diseño y combinación con el resto de elementos. Maximiza el espacio del cajón. Reduce costes y facilita la instalación de fontanería.</p> |
| LACQUERED FINISHES ACABADOS LACADOS | <p>Double layed paint on laminated fiber. Soft matte finishes. Doble capa de pintura sobre fibra laminada. Acabados mate soft.</p> | <p>No aging. It looks like the first day. Hardness and resistance lacquered surface. No envejece. Mantiene aspecto como el primer día. Dureza y resistencia de superficies lacadas.</p> |
| WOOD FINISHES ACABADOS MADERA | <p>Latest technology laminates with synchronized grain. Wide range os finishes. Laminados última tecnología con veta sincronizada. Amplia gama de acabados.</p> | <p>Ultra natural realism. They improve the resistance and properties of the natural veneer. Ultrarealismo natural. Mejoran la resistencia y las propiedades de la chapa natural.</p> |
| BASINS LAVABOS | <p>See features / washbasin range. Ver características / gama lavabos.</p> | |

ÉPOQUE

THE BEAUTY OF ART DECO



BASE UNIT MUEBLE

60cm
80cm
100cm

FINISHES ACABADOS



BLANCO SOFT



STORM GREY SOFT



NAVY



LIGHT OAK

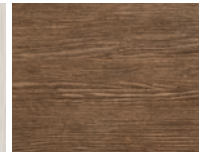

NUT OAK

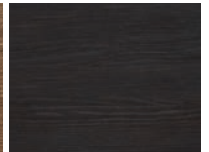

NIGHT OAK



BASIN LAVABOS

60cm
80cm
100cm

FINISHES ACABADOS



MINERAL GLOSS



MINERAL MATT



HANDLES TIRADORES

FINISHES ACABADOS



WHITE



BRUSHED GOLD

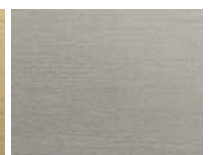

BRUSHED NICKEL



CHROME



BLACK

ÉPOQUE

CREATE YOUR ÉPOQUE
CREA TU ÉPOQUE

STEP 1
SELECT THE BASE UNIT
SELECCIONA EL ARMAZÓN

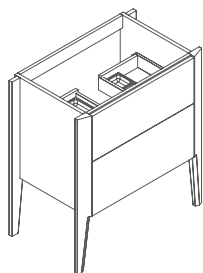

60 CM | 80 CM | 100 CM
24" | 32" | 40"

STEP 2
SELECT THE BASIN
SELECCIONA EL LAVABO

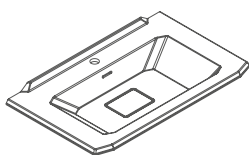

60 CM | 80 CM | 100 CM
24" | 32" | 40"

STEP 3
SELECT THE SET OF HANDLES
SELECCIONA EL TIRADOR

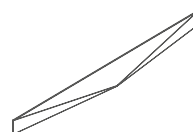

BRUSHED NICKEL | BRUSHED GOLD
CHROME | WHITE | BLACK

COMPLETE YOUR INSTALLATION
COMPLETA TU INSTALACIÓN



POP UP
PUSH DOWN
Ø 37 mm. 1 1/4"
VÁLVULA CLICKER
Ø 37 mm. 1 1/4"
CHROME / CROMO
Ref. 157051



PRELOC
WASTE P-TRAP 1 1/4"
SIFÓN DESAGÜE 1 1/4"
WHITE / BLANCO
Ref. 188291



STEP 1 | PASO 1

SELECT THE BASE UNIT
SELECCIONA EL ARMAZÓN

BASE UNIT 60 (24") ARMAZÓN 60 (24")

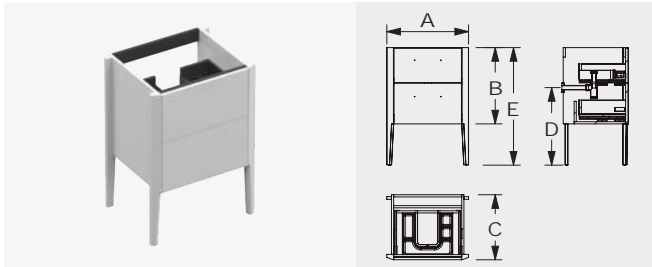

BLANCO SOFT
STORM GREY SOFT
NAVY
NUT OAK
NIGHT OAK
LIGHT OAK

Ref. 180332
Ref. 180325
Ref. 181063
Ref. 180356
Ref. 180349
Ref. 180318

A: 600 mm. B: 560 mm. C: 478 mm.
D: 570-620 E: 863 mm.

BASE UNIT 80 (32") ARMAZÓN 80 (32")

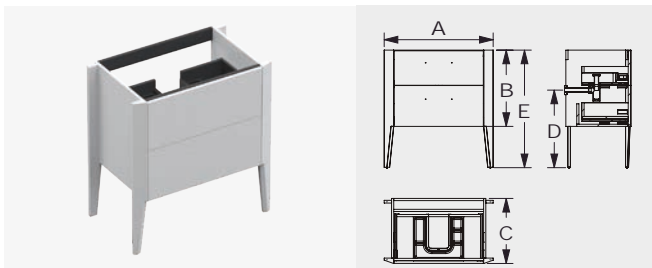

BLANCO SOFT
STORM GREY SOFT
NAVY
NUT OAK
NIGHT OAK
LIGHT OAK

Ref. 180363
Ref. 180387
Ref. 181070
Ref. 180400
Ref. 180394
Ref. 180370

A: 800 mm. B: 560 mm. C: 478 mm.
D: 570-620 E: 863 mm.

BASE UNIT 100 (40") ARMAZÓN 100 (40")

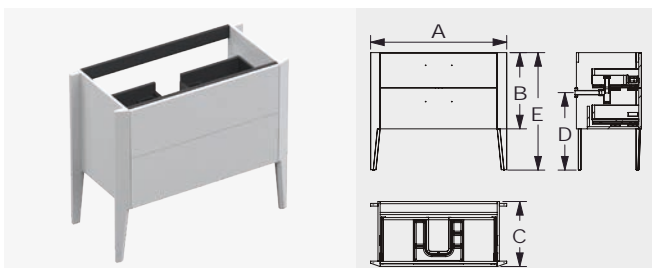

BLANCO SOFT
STORM GREY SOFT
NAVY
NUT OAK
NIGHT OAK
LIGHT OAK

Ref. 180417
Ref. 180455
Ref. 181087
Ref. 180448
Ref. 180431
Ref. 180424

A: 1000 mm. B: 560 mm. C: 478 mm.
D: 570-620 E: 863 mm.

STEP 2 | PASO 2

SELECT THE BASIN
SELECCIONA EL LAVABO

MX8 BASIN 60 1Ø (24") MX8 ENCIMERA 60 1Ø (24")

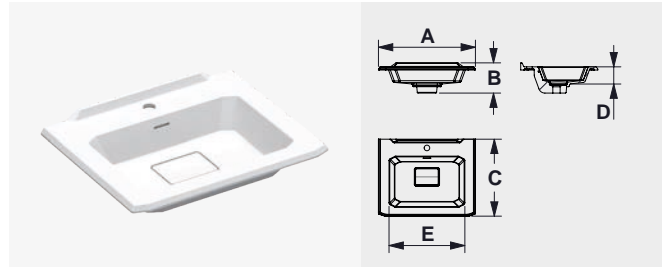

MINERAL GLOSS
MINERAL MATT

Ref. 180561
Ref. 180578

A: 610 mm. B: 166 mm.
C: 485 mm. D: 96 mm.

MX8 BASIN 80 1Ø (32") MX8 ENCIMERA 80 1Ø (32")

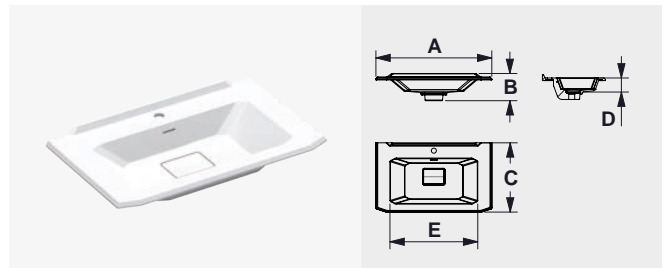

MINERAL GLOSS
MINERAL MATT

Ref. 180585
Ref. 180592

A: 810 mm. B: 166 mm.
C: 485 mm. D: 96 mm.

MX8 BASIN 100 1Ø (40") MX8 ENCIMERA 100 1Ø (40")

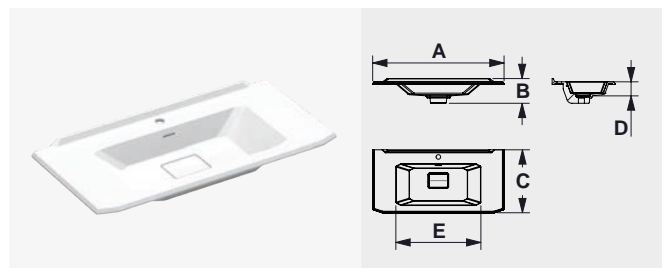

MINERAL GLOSS
MINERAL MATT

Ref. 180615
Ref. 180608

A: 1010 mm. B: 166 mm.
C: 485 mm. D: 96 mm.

ÉPOQUE



FINISH OPTIONS OPCIONES DE ACABADOS

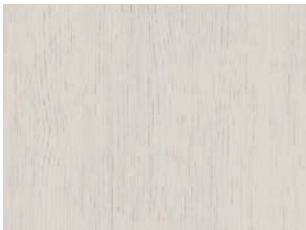

LIGHT OAK
Ref. 9992225K



NUT OAK
Ref. 9992225J

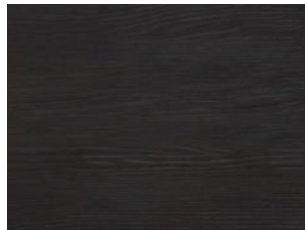

NIGHT OAK
Ref. 9992225L



BLANCO SOFT
Ref. 9992224O



STORM GREY SOFT
Ref. 9992225I



NAVY
Ref. 9992225H

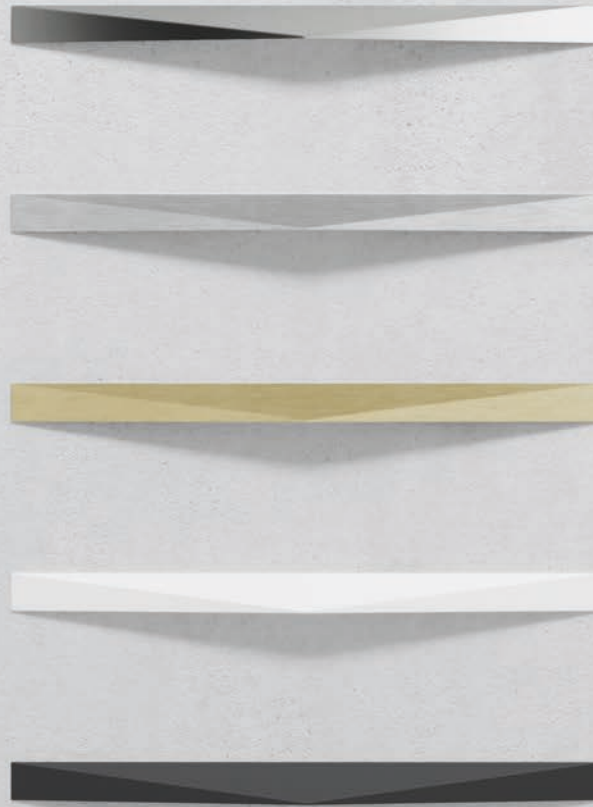

STEP 3 | PASO 3
SELECT THE SET OF HANDLES
SELECCIONA EL TIRADOR

ÉPOQUE SET HANDLE
ÉPOQUE SET DE TIRADORES

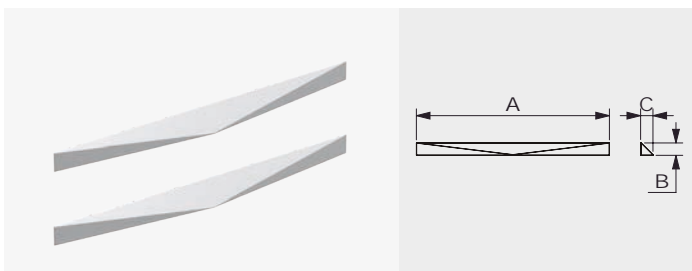

CHROME
 BRUSHED NICKEL
 BRUSHED GOLD
 WHITE
 BLACK

Ref. 181162
 Ref. 181179
 Ref. 181254
 Ref. 181247
 Ref. 181278

A: 312 mm. B: 20 mm. C: 20 mm.



CHROME



BRUSHED NICKEL



BRUSHED GOLD



WHITE



BLACK



MITTE



MITTE





MITTE



MITTE



MITTE





MITTE



MITTE





HUMIDITY RESISTANCE
RESISTENTE A LA HUMEDAD



INSTALLATION NOT REQUIRED
SIN INSTALACIÓN



MAX LOAD CAPACITY
CAPACIDAD MÁXIMA



DOUBLE LAYER PAINT
DOBLE CAPA PINTURA



3/4" (19mm) HDF THICKNESS
3/4" 19MM ESPESOR



SOFT CLOSE HARDWARE
CIERRE SUAVE



CRAFTSMANSHIP
HECHO A MANO



DRAWER ORGANIZER
CAJÓN ORGANIZADOR

| | SPECS ESPECIFICACIONES TÉCNICAS | BENEFITS BENEFICIOS |
|--|---|---|
| STRUCTURE ESTRUCTURA | Thickneses throughout the furniture of 19 mm. Particle board. HDF PVC edges 0.8 mm PUR technology (Reactive Polyurethane) Espesores de todo el mueble de 19 mm. Tablero partículas. HDF Cantos PVC 0.8 mm, tecnología PUR (Polyuretano reactivo). | Structure robustess. Humidity resistance. Estructura robusta. Resistente a la humedad. |
| DRAWERS CAJONES | 12 mm ultraslim anthracite metal drawer. Drawer depth 19 mm. Full extraction. Load capacity 30 Kg Organizers included. Regulation and adjustments front. Cajón metálico antracita ultra slim 12mm. Fondo cajón 19 mm. Extracción total. Capacidad carga 30 Kg. Organizadores incluidos. Regulación y ajuste frentes. | Design, order and cleanliness. Soft close. Capacity. Diseño, orden y limpieza. Suavidad apertura / cierre silencioso. Capacidad. |
| METAL FRAME ESTRUCTURA | Metal aluminum frame structure 25x25mm square profile. Levelers in 4 legs. Estructura en perfiles cuadrada de aluminio 25x25mm. Niveladores en las 4 patas. | Improve the functionality with the accessories. Aumentar la funcionalidad con los accesorios. |
| INSTALLATION INSTALACIÓN | Hangers + wall plate made Italy. Compliance with all regulations and standarts. Drain valves in faucet finishes: chrome, gold, white, black. Patented flexible siphon. Colgadores + placa de pared hecha en Italia. Cumplimiento de todas las normativas y estandares. Válvulas desagüe en acabados grifería: cromo, oro, blanco, negro. Sifón flexible patentado. | Reliability, safety installation. Design and combination with other elements. Maximize drawer space. Reduces costs and facilitates plumbing installation. Fiabilidad, seguridad instalación. Diseño y combinación con el resto de elementos. Maximiza el espacio del cajón. Reduce costes y facilita la instalación de fontanería. |
| LACQUERED FINISHES ACABADOS LACADOS | Double layed paint on laminated fiber. Gloss finishes. Doble capa de pintura sobre fibra laminada. Acabados brillo. | No aging. It looks like the first day. Hardness and resistance lacquered surface. No envejece. Mantiene aspecto como el primer día. Dureza y resistencia de superficies lacadas. |
| WOOD FINISHES ACABADOS MADERA | Latest technology laminates with synchronized grain. Laminados última tecnología con veta sincronizada. | Ultra natural realism. They improve the resistance and properties of the natural veneer. Ultrarealismo natural. Mejoran la resistencia y las propiedades de la chapa natural. |

MITTE

NOT INDIFFERENT



METAL FRAME + COMPLEMENTS
ESTRUCTURA + ACCESORIOS

95cm
115cm

FINISHES
ACABADOS

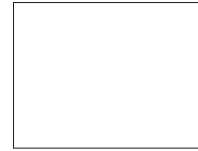

BLANCO



NEGRO



BASE UNIT
ARMAZÓN

80cm
100cm

FINISHES
ACABADOS



SNOW WOOD



RAW WOOD



SAND WOOD

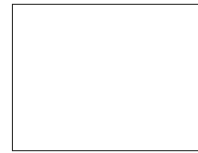

BLANCO GLOSS



TORTORA GLOSS



BASIN
LAVABO

MX10

FINISHES
ACABADOS



MINERAL GLOSS



MINERAL MATT

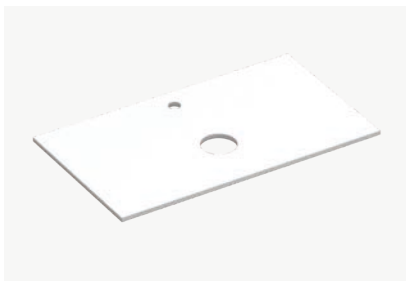

COUNTER + BASIN
ENCIMERA + LAVABO

80cm
100cm

FINISHES
ACABADOS



WHITE STONE



TORTORA STONE



DARK GREY STONE



SX12



WHITE STONE



TORTORA STONE



DARK GREY STONE

MITTE

CREATE YOUR MITTE
CREA TU MITTE

STEP 1

SELECT THE METAL FRAME

- Size
- Version

SELECCIONA LA ESTRUCTURA

- Tamaño
- Versión

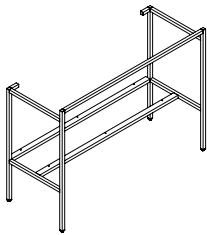

95 CM (37")
115 CM (45")

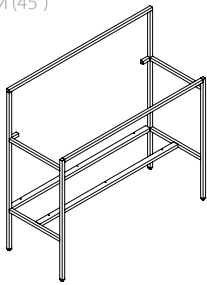

XL 95 CM (37")
XL 115 CM (45")

STEP 2

SELECT THE CABINET

SELECCIONA EL ARMAZÓN

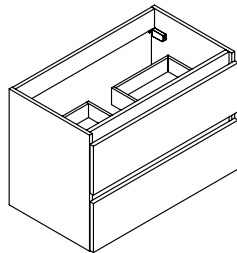

80 CM (31")

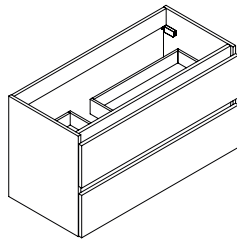

100 CM (39")

STEP 3

SELECT THE BASIN

- Basin
- Counter & basin

SELECCIONA EL LAVABO

- Lavabo
- Encimera & lavabo

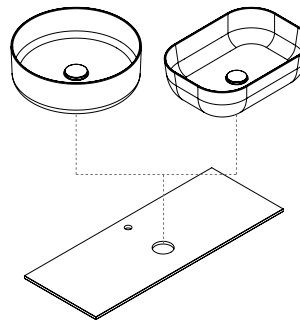
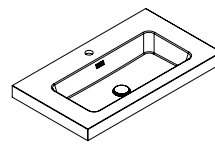

STEP 4

SELECT ACCESSORIES TO GET EXTRA FUNCTIONALITY

SELECCIONA ACCESORIOS PARA AÑADIR FUNCIONALIDAD EXTRA

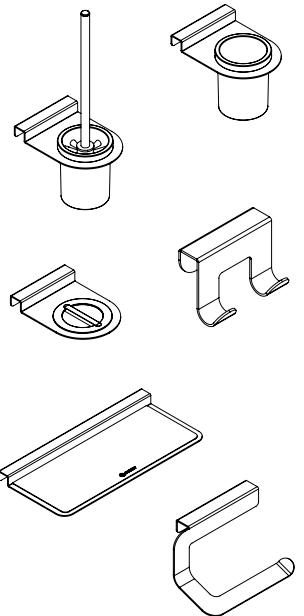

CABINET FINISH OPTIONS OPCIONES DE ACABADOS MUEBLE



SNOW WOOD
Ref. 9992226E

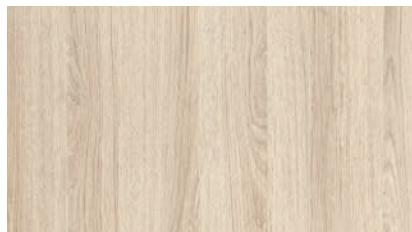

RAW WOOD
Ref. 9992226D

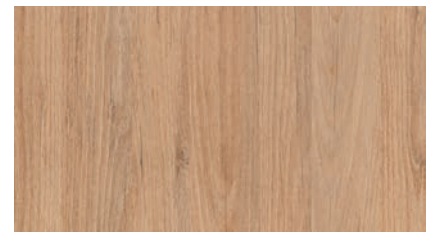

SAND WOOD
Ref. 9992226C



BLANCO GLOSS
Ref. 9992225O



TORTORA GLOSS
Ref. 9992226F

STEP 1 - SELECT THE METAL FRAME PASO 1 - SELECCIONA LA ESTRUCTURA

METAL FRAME 95 (37") ESTRUCTURA 95 (37")

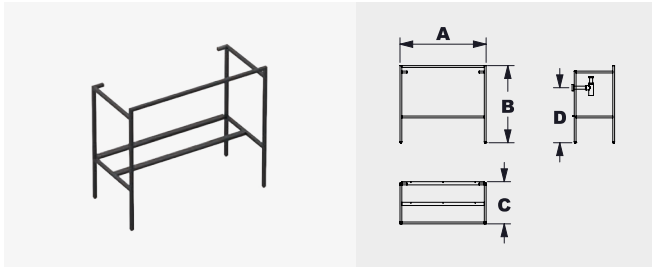

WHITE
BLACK

Ref. 186648
Ref. 186600

A: 950 mm. B: 840 mm.
C: 460 mm. D: 570-620 mm.

METAL FRAME 115 (45") ESTRUCTURA 115 (45")

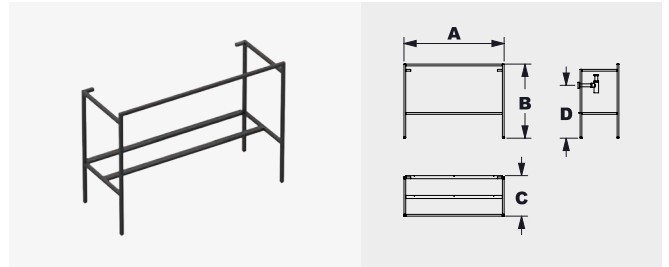

WHITE
BLACK

Ref. 186662
Ref. 186624

A: 1150 mm. B: 840 mm.
C: 460 mm. D: 570-620 mm.

XL-METAL FRAME 95 (37") ESTRUCTURA-XL 95 (37")

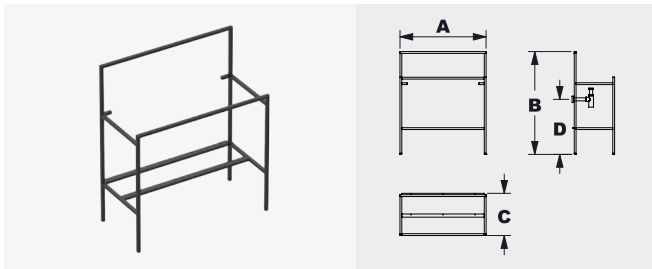

WHITE
BLACK

Ref. 186655
Ref. 186617

A: 950 mm. B: 1120 mm.
C: 460 mm. D: 570-620 mm.

XL-METAL FRAME 115 (45") ESTRUCTURA-XL 115 (45")

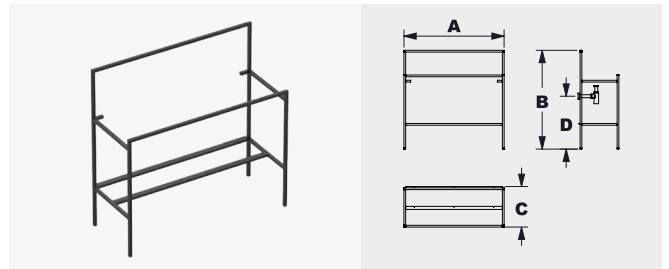

WHITE
BLACK

Ref. 186679
Ref. 186631

A: 1150 mm. B: 1120 mm.
C: 460 mm. D: 570-620 mm.

STEP 2 - SELECT THE CABINET PASO 2 - SELECCIONA EL ARMAZÓN

BASE UNIT 80 (32") ARMAZÓN 80 (32")

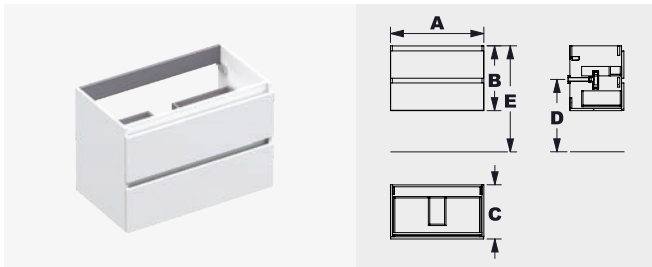

BLANCO GLOSS
TORTORA GLOSS
SNOW WOOD
RAW WOOD
SAND WOOD

Ref. 186686
Ref. 186693
Ref. 186716
Ref. 186723
Ref. 186730

A: 795 mm. B: 550 mm. C: 460 mm.
D: 560-610 mm. E: 900 mm.

BASE UNIT 100 (40") ARMAZÓN 100 (40")

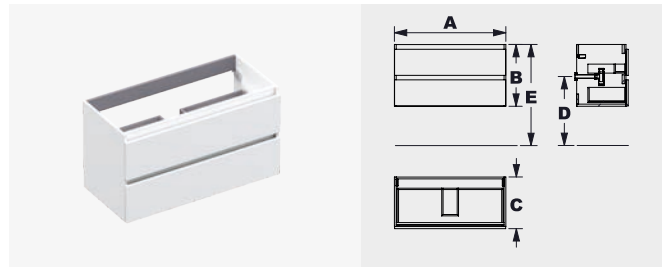

BLANCO GLOSS
TORTORA GLOSS
SNOW WOOD
RAW WOOD
SAND WOOD

Ref. 186747
Ref. 186754
Ref. 186778
Ref. 186785
Ref. 186792

A: 995 mm. B: 550 mm. C: 460 mm.
D: 560-610 mm. E: 900 mm.



COMPLETE YOUR INSTALLATION COMPLETA TU INSTALACIÓN

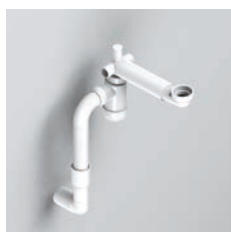

PRELOC
TRAP 1 1/4"
SIFÓN 1 1/4"
Compatible for counter SX12 basins.
Compatible con lavabos sobre encimera SX12

WHITE Ref. 188291



CLICKER
PUSH DOWN
Ø 65 mm. 1 1/4"
VÁLVULA CLICKER
Ø 65 mm. 1 1/4"

CHROME Ref. 123940
WHITE Ref. 188895
TORTORA Ref. 188901
DARK GREY Ref. 188918

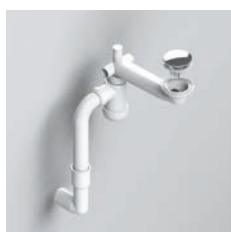

PRELOC + CLICKER
TRAP 1 1/4"
SIFÓN 1 1/4"
Compatible for MX10 basins
Compatible con lavabos MX10

CLICKER CHROME Ref. 161508
CLICKER WHITE Ref. 190102

STEP 3 - SELECT THE BASIN + COUNTER OR BASIN PASO 3 - SELECCIONA LA ENCIMERA O LAVABO + ENCIMERA PLANA

SX12 BASIN CERAMIC 44x32 (17x12") SX12 LAVABO CERÁMICA 44x32

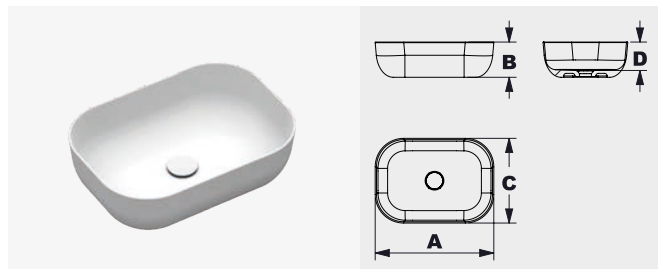

WHITE MATT Ref. 187362
TORTORA MATT Ref. 187379
DARK GREY MATT Ref. 187386

A: 455 mm. B: 135 mm.
C: 325 mm. D: 109 mm.

SX12 BASIN CERAMIC Ø15 SX12 LAVABO CERÁMICA Ø15

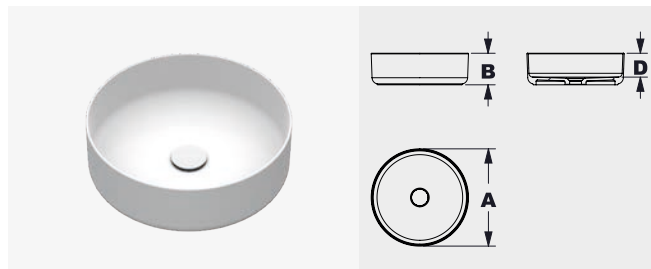

WHITE MATT Ref. 187331
TORTORA MATT Ref. 187348
DARK GREY MATT Ref. 187355

A: 370 mm. B: 120 mm. D: 91 mm.

MICROTECH COUNTER 80 1Ø (32") MICROTECH ENCIMERA 80 1Ø (32")

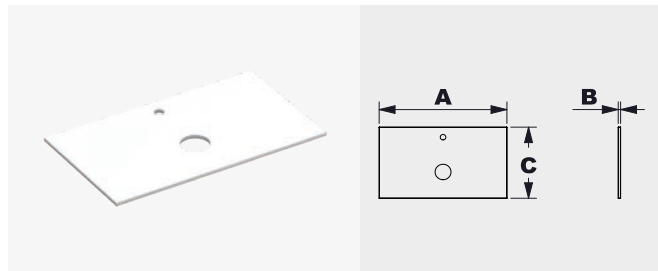

WHITE STONE Ref. 187393
TORTORA STONE Ref. 187416
DARK GREY STONE Ref. 187430

A: 805 mm. B: 15 mm. C: 460 mm.

MICROTECH COUNTER 100 1Ø (40") MICROTECH ENCIMERA 100 1Ø (40")

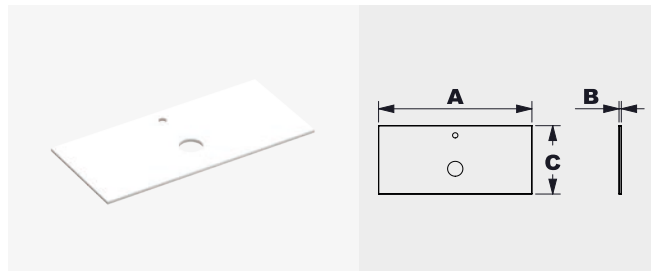

WHITE STONE Ref. 187409
TORTORA STONE Ref. 187423
DARK GREY STONE Ref. 187447

A: 1005 mm. B: 15 mm. C: 460 mm.

MX10 BASIN 80 1Ø (32") MX10 ENCIMERA 80 1Ø (32")

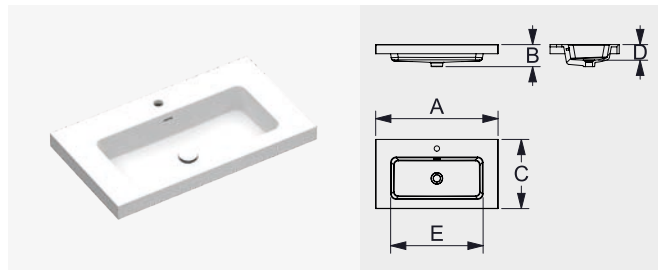

MINERAL MATT Ref. 186907
MINERAL GLOSS Ref. 186914

A: 805 mm. B: 145 mm. C: 455 mm.
D: 100 mm. E: 600 mm.

MX10 BASIN 100 1Ø (40") MX10 ENCIMERA 100 1Ø (40")

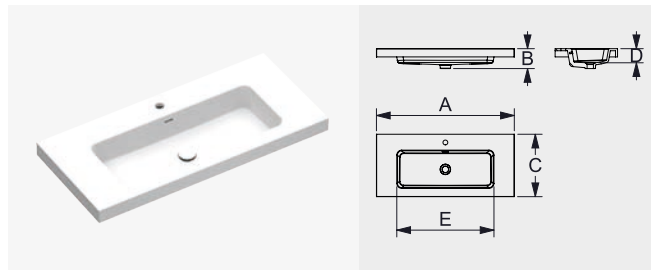

MINERAL MATT Ref. 186921
MINERAL GLOSS Ref. 186938

A: 1005 mm. B: 145 mm. C: 455 mm.
D: 100 mm. E: 700 mm.

FINISH OPTIONS OPCIONES DE ACABADOS

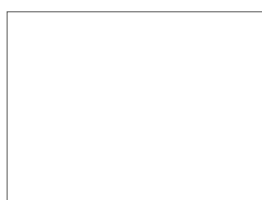

WHITE STONE



DARK GREY STONE



TORTORA STONE

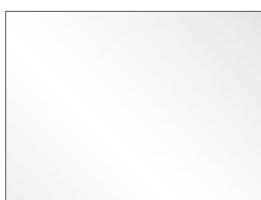

MINERAL GLOSS

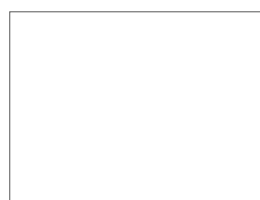

MINERAL MATT

MITTE



STEP 4 - ACCESSORIES PASO 4 - ACCESORIOS



HAIR STRAIGHTENER HOLDER
SOPORTE PLANCHA

BLACK
A: 120 mm, B: 25 mm, C: 163 mm.

Ref. 186846



HAIR DRYER HOLDER
SOPORTE SECADOR

BLACK
A: 120 mm, B: 25 mm, C: 163 mm.

Ref. 186839



DOUBLE ROBE HOOK
PERCHA DOBLE

BLACK
A: 90 mm, B: 65 mm, C: 51 mm.

Ref. 177011



SHELF 350 MM (14")
REPISA 350 MM

BLACK
A: 350 mm, B: 22 mm, C: 163 mm.

Ref. 186808



TUMBLER HOLDER
PORTAVASOS

BLACK
A: 120 mm, B: 118 mm, C: 163 mm.

Ref. 186815



TOILET ROLL HOLDER
PORTARROLLOS

BLACK
A: 159 mm, B: 104 mm, C: 98 mm.

Ref. 176939



WC BRUSH SET
ESCOBILLERO

BLACK
A: 120 mm, B: 363 mm, C: 163 mm.

Ref. 186822

MITTE



STEP 4 - ACCESSORIES PASO 4 - ACCESORIOS



HAIR STRAIGHTENER HOLDER
SOPORTE PLANCHA

WHITE
A: 120 mm, B: 25 mm, C: 163 mm.

Ref. 186891



HAIR DRYER HOLDER
SOPORTE SECADOR

WHITE
A: 120 mm, B: 25 mm, C: 163 mm.

Ref. 186884



DOUBLE ROBE HOOK
PERCHA DOBLE

WHITE
A: 90 mm, B: 65 mm, C: 51 mm.

Ref. 177004



SHELF 350 MM (14")
REPISA 350 MM

WHITE
A: 350 mm, B: 22 mm, C: 163 mm.

Ref. 186853



TUMBLER HOLDER
PORTAVASOS

WHITE
A: 120 mm, B: 118 mm, C: 163 mm.

Ref. 186860



TOILET ROLL HOLDER
PORTARROLLOS

WHITE
A: 159 mm, B: 104 mm, C: 98 mm.

Ref. 176946



WC BRUSH SET
ESCOBILLERO

WHITE
A: 120 mm, B: 363 mm, C: 163 mm.

Ref. 186877



PLAY



PLAY





PLAY







PLAY





HUMIDITY RESISTANCE
RESISTENTE A LA HUMEDAD



INSTALLATION TO THE WALL
INSTALACIÓN A PARED



MAX LOAD CAPACITY
CAPACIDAD MÁXIMA



DOUBLE LAYER PAINT
DOBLE CAPA PINTURA



3/4" (19mm) HDF THICKNESS
3/4" 19MM ESPESOR



SOFT CLOSE HARDWARE
CIERRE SUAVE



CRAFTSMANSHIP
HECHO A MANO



DRAWER ORGANIZER
CAJÓN ORGANIZADOR

| | SPECS ESPECIFICACIONES TÉCNICAS | BENEFITS BENEFICIOS |
|--|---|---|
| STRUCTURE ESTRUCTURA | <p>Thicknesses throughout the furniture of 19 mm. Particle board. HDF PVC edges 0.8 mm PUR technology (Reactive Polyurethane) Espesores de todo el mueble de 19 mm. Tablero partículas. HDF Cantos PVC 0.8 mm, tecnología PUR (Polyuretano reactivo).</p> | <p>Structure robustness. Humidity resistance. Estructura robusta. Resistente a la humedad.</p> |
| DRAWERS CAJONES | <p>12 mm ultraslim anthracite metal drawer. Drawer depth 19 mm. Full extraction. Load capacity 30 Kg Organizers included. Regulation and adjustments front. Cajón metálico antracita ultra slim 12mm. Fondo cajón 19 mm. Extracción total. Capacidad carga 30 Kg. Organizadores incluidos. Regulación y ajuste frentes.</p> | <p>Design, order and cleanliness. Soft close. Capacity. Diseño, orden y limpieza. Suavidad apertura / cierre silencioso. Capacidad.</p> |
| HANDLES TIRADORES | <p>Materials: stainless steel, zamak, aluminium. Fishing technology: Anodized, PVD, electrolyc, thermosetting coating. Materiales: acero inoxidable, zamak, aluminio. Tecnología acabados: Anodizados, PVD, electrolíticos, recubrimiento termoendurecido.</p> | <p>Wide range of metallic finishes. Resistance and durability. Amplia gama de acabados metálicos. Resistencia y durabilidad.</p> |
| INSTALLATION INSTALACIÓN | <p>Hangers + wall plate made Italy. Compliance with all regulations and standarts. Drain valves in faucet finishes: chrome, gold, white, black. Patented flexible siphon. Colgadores + placa de pared hecha en Italia. Cumplimiento de todas las normativas y estandares. Válvulas desagüe en acabados grifería: cromo, oro, blanco, negro. Sifón flexible patentado.</p> | <p>Reliability, safety installation. Design and combination with other elements. Maximize drawer space. Reduces costs and facilitates plumbing installation. Fiabilidad, seguridad instalación. Diseño y combinación con el resto de elementos. Maximiza el espacio del cajón. Reduce costes y facilita la instalación de fontanería.</p> |
| LACQUERED FINISHES ACABADOS LACADOS | <p>Double layed paint on laminated fiber. Soft matte finishes. Doble capa de pintura sobre fibra laminada. Acabados mate soft.</p> | <p>No aging. It looks like the first day. Hardness and resistance lacquered surface. No envejece. Mantiene aspecto como el primer día. Dureza y resistencia de superficies lacadas.</p> |
| WOOD FINISHES ACABADOS MADERA | <p>Latest technology laminates with synchronized grain. Laminados última tecnología con veta sincronizada.</p> | <p>Ultra natural realism. They improve the resistance and properties of the natural veneer. Ultrarealismo natural. Mejoran la resistencia y las propiedades de la chapa natural.</p> |

PLAY

CONTEMPORARY NEOCLASSIC



BASE UNIT
MUEBLE

FINISHES
ACABADOS

80cm
100cm



OAKWOOD



TOBACCO WOOD



BLANCO SOFT



STORM GREY SOFT



BASIN
LAVABO

FINISHES
ACABADOS

MX1
MX3
SX7



MINERAL MARMO



MINERAL SOLID

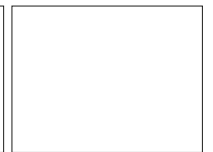

CERAMIC



WALL VITRINE
COLUMNNA

FINISHES
ACABADOS

160cm

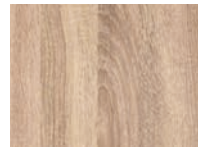

OAKWOOD

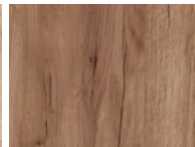

TOBACCO WOOD



BLANCO SOFT



STORM GREY SOFT



HANDLES
TIRADORES

FINISHES
ACABADOS



WHITE



BRUSHED GOLD



BRUSHED NICKEL



CHROME



BLACK

PLAY

CREATE YOUR PLAY
CREA TU PLAY

STEP 1
SELECT THE BASE UNIT
SELECCIONA EL ARMAZÓN

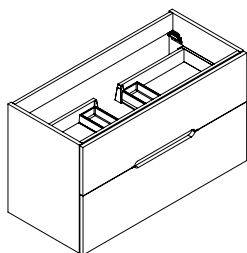

80 CM | 100 CM
32" | 40"

STEP 2
SELECT THE BASIN
SELECCIONA EL LAVABO

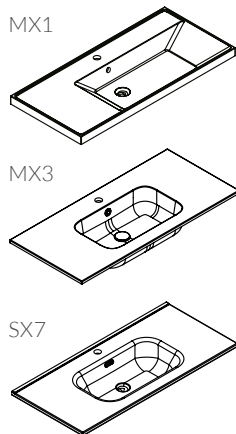

80 CM | 100 CM
32" | 40"

STEP 3
SELECT THE WALL VITRINE
SELECCIONA LA COLUMNA

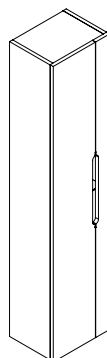

STEP 4
SELECT THE SET OF HANDLES
SELECCIONA LOS TIRADORES

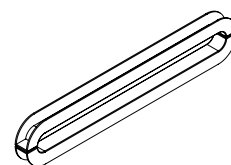

BRUSHED NICKEL
BRUSHED GOLD
CHROME | WHITE | BLACK

STEP 1 - SELECT THE BASE UNIT
STEP 1 - SELECCIONA EL ARMAZÓN

BASE UNIT 80 (32")
ARMAZÓN 80 (32")

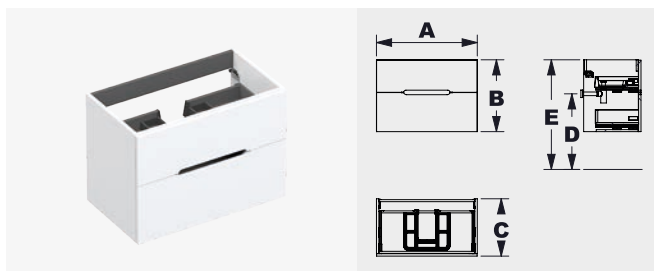

BLANCO SOFT
STORM GREY SOFT
OAKWOOD
TOBACCO WOOD

Ref. 186952
Ref. 186969
Ref. 186976
Ref. 187737

A: 800 mm. B: 570 mm. C: 458 mm.
D: 650 mm. E: 890 mm.

BASE UNIT 100 (40")
ARMAZÓN 100 (40")

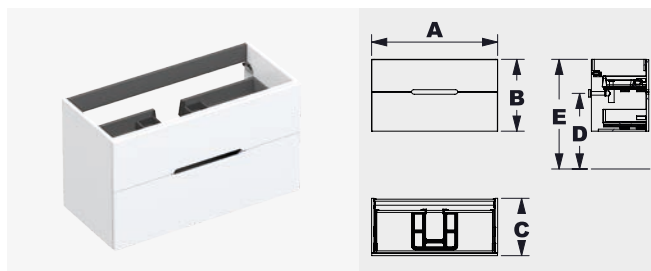

BLANCO SOFT
STORM GREY SOFT
OAKWOOD
TOBACCO WOOD

Ref. 186983
Ref. 186990
Ref. 187003
Ref. 187744

A: 1000 mm. B: 570 mm. C: 458 mm.
D: 650 mm. E: 890 mm.

FINISH OPTIONS
OPCIONES DE ACABADOS

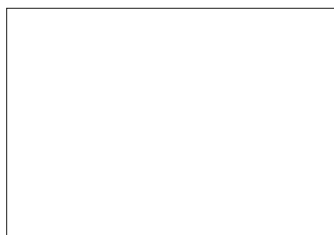

BLANCO SOFT
Ref. 9992224O



STORM GREY SOFT
Ref. 9992226G

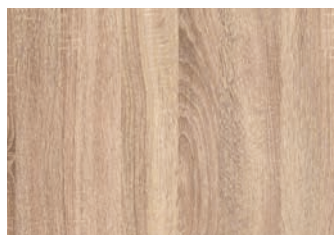

OAK WOOD
Ref. 9992225G



TOBACCO WOOD
Ref. 9992226A

STEP 2 - SELECT THE BASIN
STEP 2 - SELECCIONA EL LAVABO

MX1 BASIN 80 1Ø (32")
MX1 ENCIMERA 80 1Ø (32")

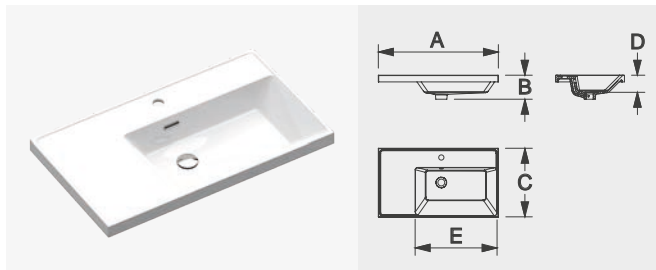

MINERAL MARMO®

Ref. 161171

A: 806 mm. B: 161 mm. C: 463 mm.
D: 115 mm. E: 546 mm.
Available with ØØ Disponible en ØØ.

MX1 BASIN 100 1Ø (40")
MX1 ENCIMERA 100 1Ø (40")

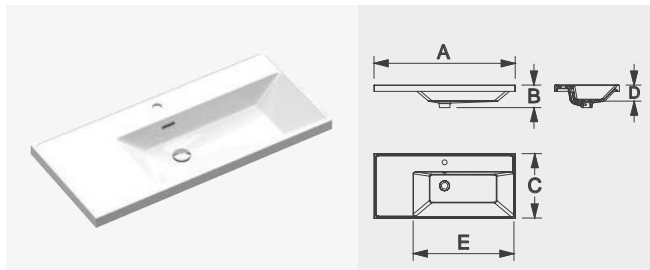

MINERAL MARMO®

Ref. 161188

A: 1006 mm. B: 161 mm. C: 463 mm.
D: 115 mm. E: 718 mm.
Available with ØØ Disponible en ØØ.

MX3 BASIN 80 1Ø (32")
MX3 ENCIMERA 80 1Ø (32")

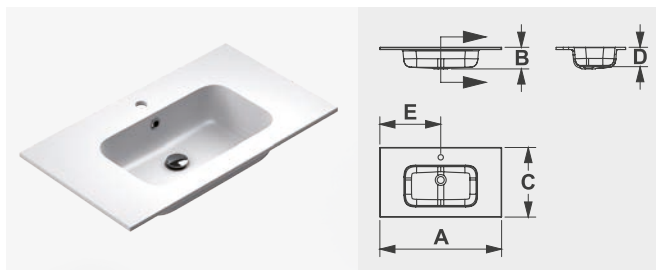

MINERAL SOLID®

Ref. 168873

A: 805 mm. B: 143 mm. C: 460 mm.
D: 128 mm. E: 400 mm.

MX3 BASIN 100 1Ø (40")
MX3 ENCIMERA 100 1Ø (40")

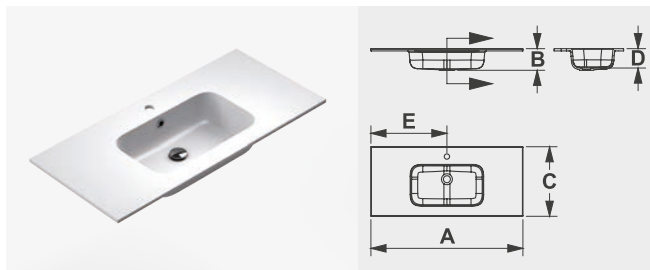

MINERAL SOLID®

Ref. 168897

A: 1005 mm. B: 143 mm. C: 460 mm.
D: 128 mm. E: 500 mm.

SX7 BASIN 80 1Ø (32")
SX7 ENCIMERA 80 1Ø (32")

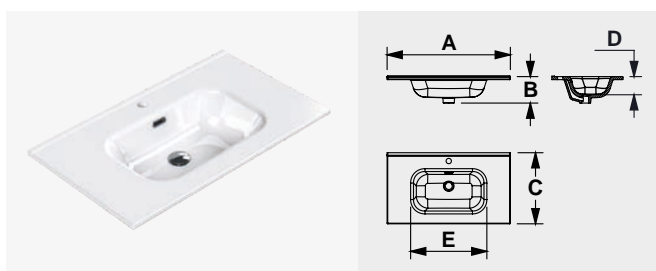

CERAMIC / CERÁMICA

Ref. 161423

A: 815 mm. B: 175 mm. C: 465 mm.
D: 120 mm. E: 500 mm.

SX7 BASIN 100 1Ø (40")
SX7 ENCIMERA 100 1Ø (40")

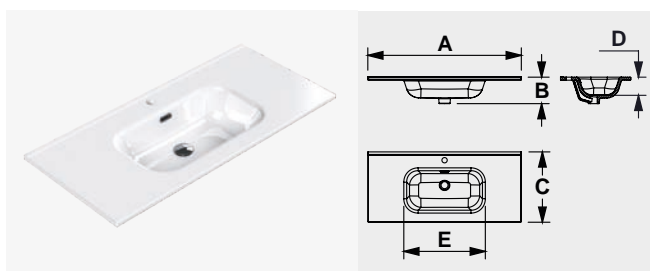

CERAMIC / CERÁMICA

Ref. 161430

A: 1015 mm. B: 175 mm. C: 465 mm.
D: 120 mm. E: 505 mm.



STEP 3 - SELECT THE WALL VITRINE
STEP 3 - SELECCIONA LA COLUMNA

WALL VITRINE 160 (64")
COLUMNA 160 (64")

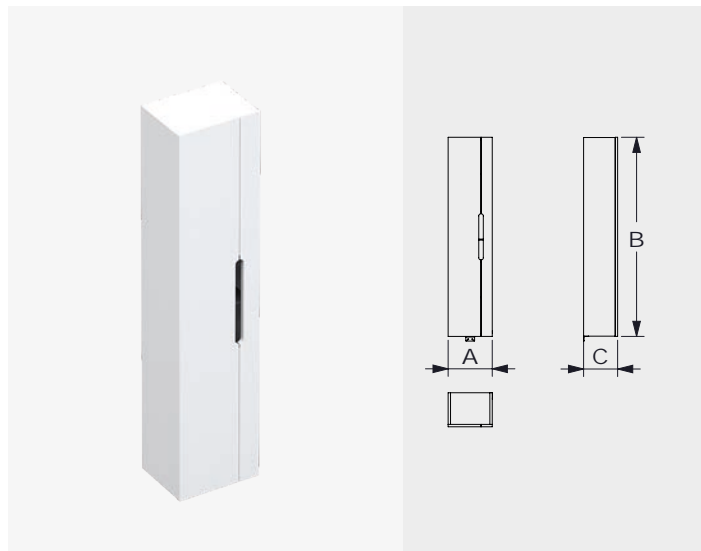

BLANCO SOFT
STORM GREY SOFT
OAK WOOD
TOBACCO WOOD

Ref. 187010 A:350 mm. B: 1580 mm. C: 270 mm.
Ref. 187027
Ref. 187034
Ref. 187751

FINISH OPTIONS
OPCIONES DE ACABADOS



BLANCO SOFT
Ref. 9992224O



STORM GREY SOFT
Ref. 9992226G

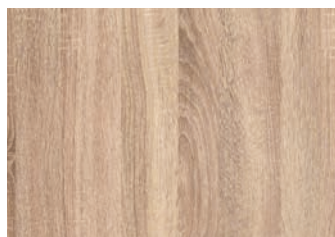

OAK WOOD
Ref. 9992225G



TOBACCO WOOD
Ref. 9992226A

COMPLETE YOUR INSTALLATION
COMPLETA TU INSTALACIÓN

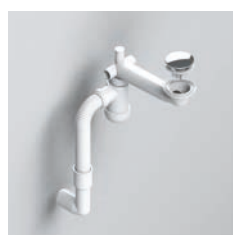

PRELOC + CLICKER
TRAP 1 1/4"
SIFÓN 1 1/4"

CLICKER CHROME Ref. 161508
CLICKER WHITE Ref. 190102

PLAY



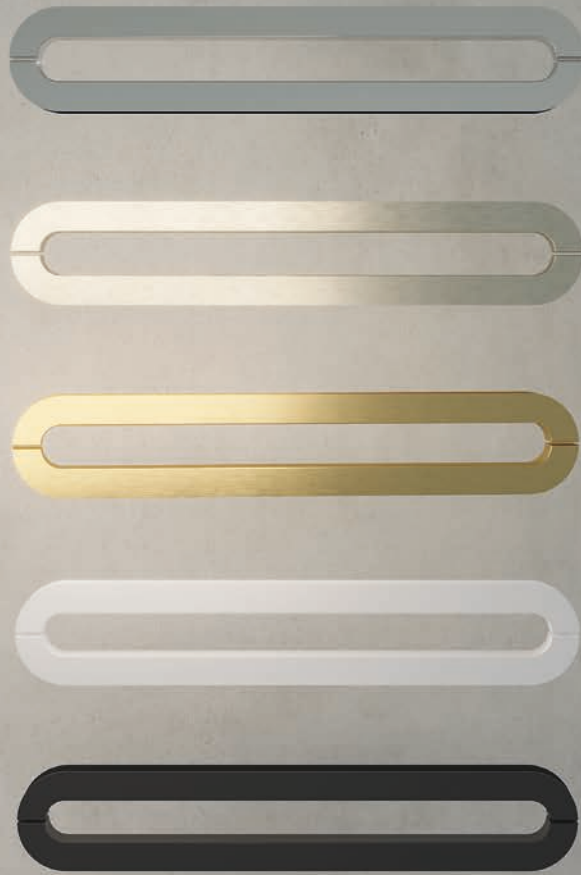

STEP 4 - SELECT THE SET OF HANDLES
 STEP 4 - SELECCIONA LOS TIRADORES

PLAY SET HANDLE
 PLAY SET DE TIRADORES

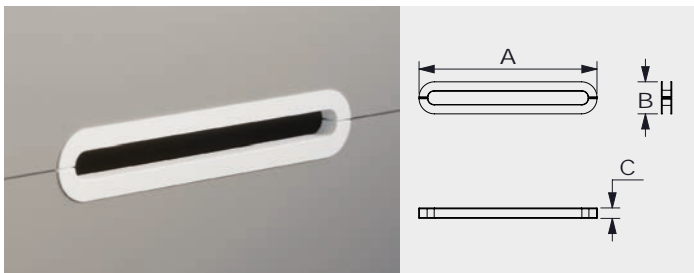

CHROME / CROMO
 BRUSHED NICKEL
 BRUSHED GOLD
 WHITE
 BLACK

Ref. 181155
 Ref. 181131
 Ref. 181124
 Ref. 182039
 Ref. 181148

A: 400 mm. B: 72 mm. C: 24 mm.



CHROME / CROMO



BRUSHED NICKEL



BRUSHED GOLD



WHITE



BLACK



CODE



CODE



CODE



CODE



CODE



CODE



CODE



CODE



CODE





HUMIDITY RESISTANCE
RESISTENTE A LA HUMEDAD



INSTALLATION TO THE WALL
INSTALACIÓN A PARED



MAX LOAD CAPACITY
CAPACIDAD MÁXIMA



DOUBLE LAYER PAINT
DOBLE CAPA PINTURA



3/4" (19mm) HDF THICKNESS
3/4" 19MM ESPESOR



SOFT CLOSE HARDWARE
CIERRE SUAVE



CRAFTSMANSHIP
HECHO A MANO



DRAWER ORGANIZER
CAJÓN ORGANIZADOR

| | SPECS ESPECIFICACIONES TÉCNICAS | BENEFITS BENEFICIOS |
|---|--|---|
| STRUCTURE ESTRUCTURA | <p>Thicknesses throughout the furniture of 19 mm. Particle board. HDF PVC edges 0.8 mm PUR technology (Reactive Polyurethane) Espesores de todo el mueble de 19 mm. Tablero partículas. HDF Cantos PVC 0.8 mm, tecnología PUR (Polyuretano reactivo).</p> | <p>Structure robustness. Humidity resistance. Estructura robusta. Resistente a la humedad.</p> |
| DRAWERS CAJONES + DOORS PUERTAS | <p>12 mm ultraslim anthracite metal drawer. Drawer depth 19 mm. Full extraction. Load capacity 30 Kg Organizers included. Regulation and adjustments front. Doors 80 and 100 cm. Cajón metálico antracita ultra slim 12mm. Fondo cajón 19 mm. Extracción total. Capacidad carga 30 Kg. Organizadores incluidos. Regulación y ajuste frentes. Puertas de 80 y 100 cm.</p> | <p>Design, order and cleanliness. Soft close. Capacity. Diseño, orden y limpieza. Suavidad apertura / cierre silencioso. Capacidad.</p> |
| INSTALLATION INSTALACIÓN | <p>Hangers + wall plate made Italy. Compliance with all regulations and standarts. Drain valves in faucet finishes: chrome, gold, white, black. Patented flexible siphon. Colgadores + placa de pared hecha en Italia. Cumplimiento de todas las normativas y estandares. Válvulas desagüe en acabados grifería: cromo, oro, blanco, negro. Sifón flexible patentado.</p> | <p>Reliability, safety installation. Design and combination with other elements. Maximize drawer space. Reduces costs and facilitates plumbing installation. Fiabilidad, seguridad instalación. Diseño y combinación con el resto de elementos. Maximiza el espacio del cajón. Reduce costes y facilita la instalación de fontanería.</p> |
| LACQUERED FINISHES ACABADOS LACADOS | <p>Double layed paint on laminated fiber. Soft matte finishes. Glossy white finish. Doble capa de pintura sobre fibra laminada. Acabados mate soft. Acabado blanco brillo.</p> | <p>No aging. It looks like the first day. Hardness and resistance lacquered surface. No envejece. Mantiene aspecto como el primer día. Dureza y resistencia de superficies lacadas.</p> |
| WOOD FINISHES ACABADOS MADERA | <p>Latest technology laminates with synchronized grain. Laminados última tecnología con veta sincronizada.</p> | <p>Ultra natural realism. They improve the resistance and properties of the natural veneer. Ultrarealismo natural. Mejoran la resistencia y las propiedades de la chapa natural.</p> |

CODE

DISCREET AND SIMPLE EVERYWHERE



BASE UNIT MUEBLE

60cm
80cm
100cm
120cm



NORDIC WOOD



OAK WOOD

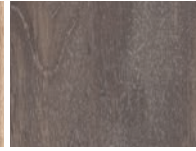

STORM WOOD

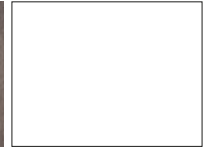

BLANCO GLOSS

FINISHES ACABADOS



BASIN LAVABO

MX1
SX7



MINERAL MARMO



CERAMIC

FINISHES ACABADOS



WALL VITRINE COLUMNNA

120cm



NORDIC WOOD



OAK WOOD



STORM WOOD



BLANCO GLOSS

FINISHES ACABADOS

CODE

CREATE YOUR CODE
CREA TU CODE

STEP 1
SELECT THE BASE UNIT
SELECCIONA EL ARMAZÓN

STEP 2
SELECT THE BASIN
SELECCIONA EL LAVABO

STEP 3
SELECT THE COMPLEMENTS
SELECCIONA LOS COMPLEMENTOS

STEP 1 - SELECT THE BASE UNIT
STEP 1 - SELECCIONA EL ARMAZÓN

CODE BASE UNIT 60 (24")
CODE ARMAZÓN 60 (24")

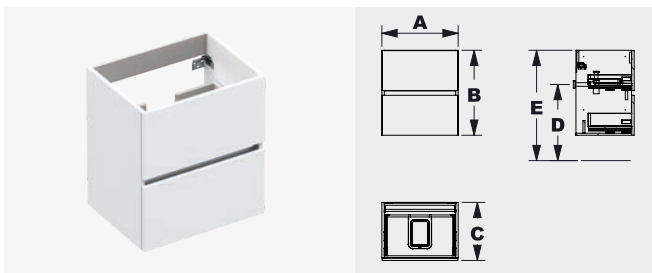

BLANCO GLOSS
NORDIC WOOD
OAK WOOD
STORM WOOD

Ref. 187041
Ref. 187065
Ref. 187072
Ref. 187096

A: 600 mm. B: 670 mm. C: 458 mm.
D: 570-620 mm. E: 870 mm.

CODE BASE UNIT 80 (32")
CODE ARMAZÓN 80 (32")

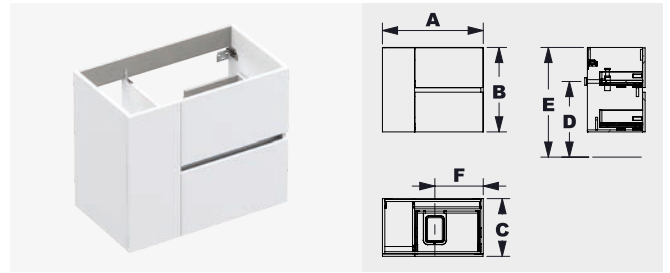

BLANCO GLOSS
NORDIC WOOD
OAK WOOD
STORM WOOD

Ref. 187102
Ref. 187126
Ref. 187133
Ref. 187157

A: 800 mm. B: 670 mm. C: 458 mm.
D: 570-620 mm. E: 870 mm. F: 386 mm.

CODE BASE UNIT 100 (40")
CODE ARMAZÓN 100 (40")

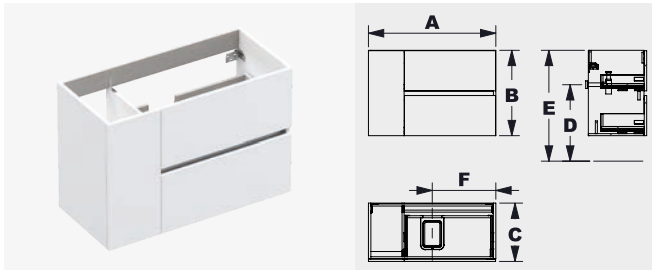

BLANCO GLOSS
NORDIC WOOD
OAK WOOD
STORM WOOD

Ref. 187164
Ref. 187188
Ref. 187195
Ref. 187218

A: 1000 mm. B: 670 mm. C: 458 mm.
D: 570-620 mm. E: 870 mm. F: 499 mm.

CODE BASE UNIT 120 (47")
CODE ARMAZÓN 120 (47")

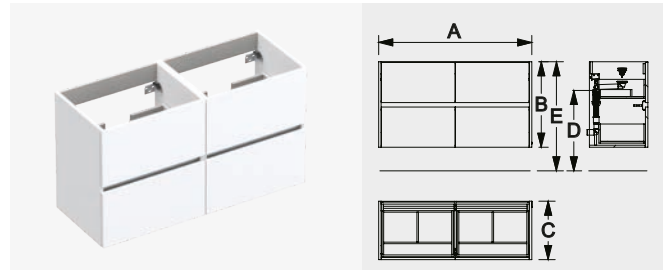

BLANCO GLOSS
NORDIC WOOD
OAK WOOD
STORM WOOD

Ref. 188581
Ref. 188598
Ref. 188604
Ref. 188611

A: 1200 mm. B: 670 mm. C: 458 mm.
D: 570-620 mm. E: 870 mm. F: 601 mm.

FINISH OPTIONS
OPCIONES DE ACABADOS



BLANCO GLOSS
Ref. 9992225O



NORDIC WOOD
Ref. 9992225Y

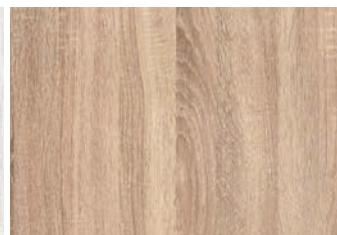

OAK WOOD
Ref. 9992225V

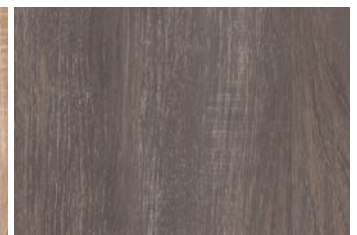

STORM WOOD
Ref. 9992226B

STEP 2 - SELECT THE BASIN STEP 2 - SELECCIONA EL LAVABO

SX7 BASIN 60 1Ø (24") SX7 ENCIMERA 60 1Ø (24")

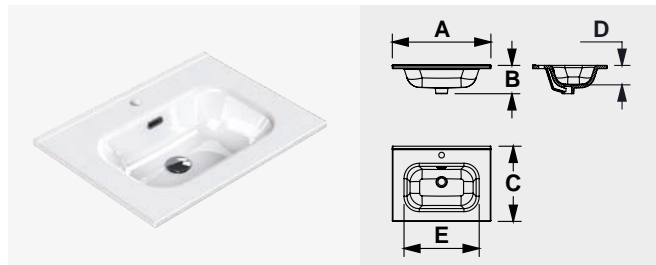

CERAMIC / CERÁMICA

Ref. 161416

A: 615 mm. B: 175 mm. C: 465 mm.
D: 120 mm. E: 465 mm.

MX1 BASIN 60 1Ø (24") MX1 ENCIMERA 60 1Ø (24")

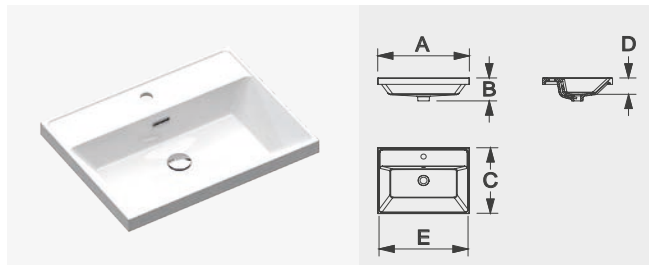

MINERAL MARMO®

Ref. 161195

A: 606 mm. B: 161 mm. C: 463 mm.
D: 115 mm. E: 585 mm.

Available with ØØ Disponible en ØØ.

SX7 BASIN 80 1Ø (32") SX7 ENCIMERA 80 1Ø (32")

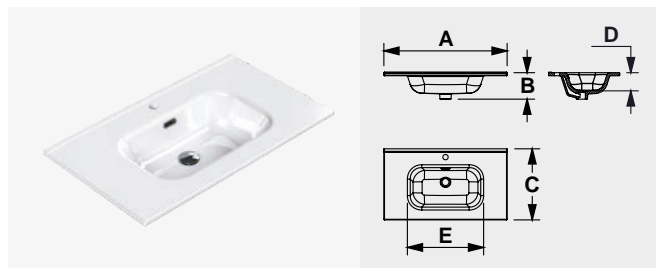

CERAMIC / CERÁMICA

Ref. 161423

A: 815 mm. B: 175 mm. C: 465 mm.
D: 120 mm. E: 500 mm.

MX1 BASIN 80 1Ø (32") MX1 ENCIMERA 80 1Ø (32")

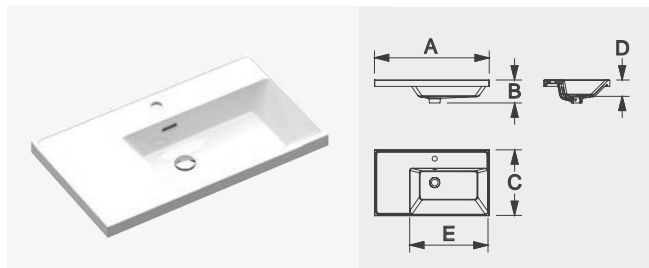

MINERAL MARMO®

Ref. 161171

A: 806 mm. B: 161 mm. C: 463 mm.
D: 115 mm. E: 546 mm.

Available with ØØ Disponible en ØØ.

SX7 BASIN 100 1Ø (40") SX7 ENCIMERA 100 1Ø (40")

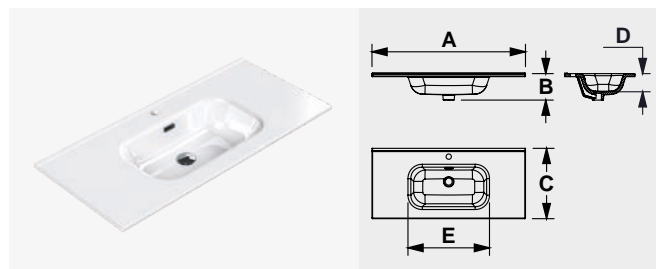

CERAMIC / CERÁMICA

Ref. 161430

A: 1015 mm. B: 175 mm. C: 465 mm.
D: 120 mm. E: 535 mm.

MX1 BASIN 100 1Ø (40") MX1 ENCIMERA 100 1Ø (40")

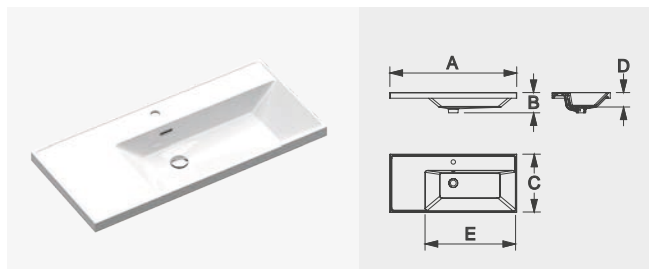

MINERAL MARMO®

Ref. 161188

A: 1006 mm. B: 161 mm. C: 463 mm.
D: 115 mm. E: 718 mm.

Available with ØØ Disponible en ØØ.

SX7 BASIN 120 1Ø DOUBLE (48") SX7 ENCIMERA DOBLE 120 1Ø (48")

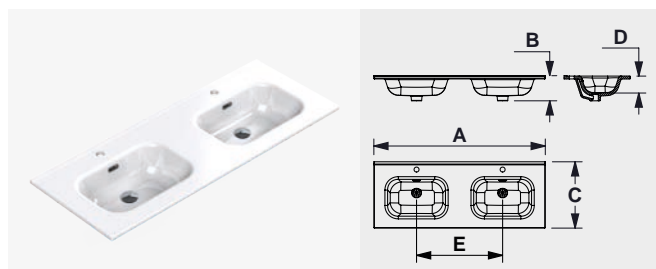

CERAMIC / CERÁMICA

Ref. 161447

A: 1215 mm. B: 175 mm. C: 465 mm.
D: 120 mm. E: 610 mm.

MX1 BASIN 120 1Ø DOUBLE (48") MX1 ENCIMERA DOBLE 120 1Ø (48")

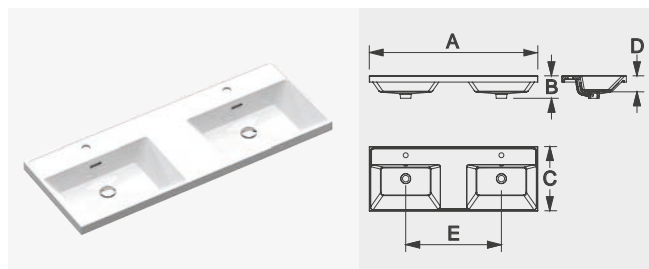

MINERAL MARMO®

Ref. 161201

A: 1206 mm. B: 161 mm. C: 463 mm.
D: 115 mm. E: 687 mm.

Available with ØØ Disponible en ØØ.

CODE



STEP 3 - SELECT THE COMPLEMENTS
STEP 3 - SELECCIONA LOS COMPLEMENTOS

WALL VITRINE 120 (48")
COLUMNA 120 (48")

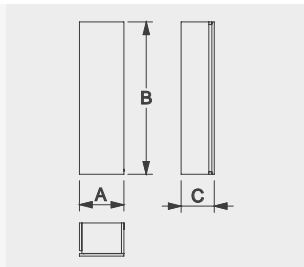

BLANCO GLOSS
NORDICWOOD
OAKWOOD
STORMWOOD

Ref. 161379
Ref. 187225
Ref. 172702
Ref. 187256

A: 350 mm. B: 1200 mm. C: 261 mm.

TRAP COVER TRAY
BANDEJA CUBRE SIFÓN

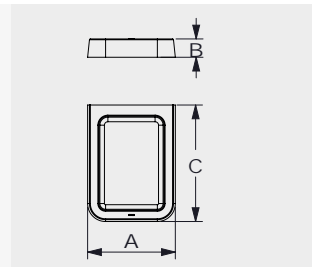

WHITE / BLANCO

Ref. 190119

COMPLETE YOUR INSTALLATION
COMPLETA TU INSTALACIÓN

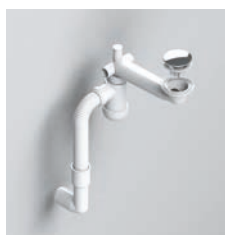

PRELOC + CLICKER
TRAP 1 1/4"
SIFÓN 1 1/4"

CLICKER CHROME Ref. 161508
CLICKER WHITE Ref. 190102

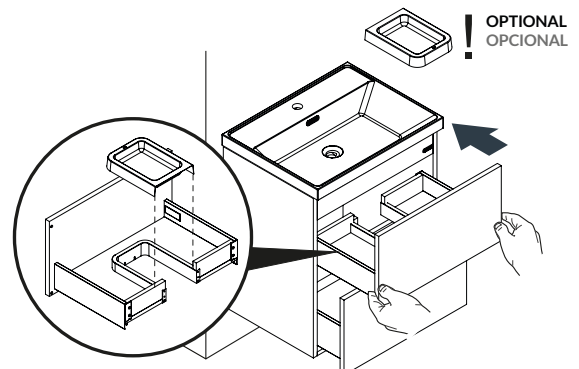

CODE



PUZZLE





PUZZLE



PUZZLE



PUZZLE



PUZZLE





HUMIDITY RESISTANCE
RESISTENTE A LA HUMEDAD



INSTALLATION TO THE WALL
INSTALACIÓN A PRED



MAX LOAD CAPACITY
CAPACIDAD MÁXIMA



DOUBLE LAYER PAINT
DOBLE CAPA PINTURA



3/4" (19mm) HDF THICKNESS
3/4" 19MM ESPESOR



SOFT CLOSE HARDWARE
CIERRE SUAVE



CRAFTSMANSHIP
HECHO A MANO



DRAWER ORGANIZER
CAJÓN ORGANIZADOR

| | SPECS ESPECIFICACIONES TÉCNICAS | BENEFITS BENEFICIOS |
|--|---|---|
| STRUCTURE ESTRUCTURA | Thicknesses throughout the furniture of 19 mm. Particle board. HDF PVC edges 0.8 mm PUR technology (Reactive Polyurethane) Espesores de todo el mueble de 19 mm. Tablero partículas. HDF Cantos PVC 0.8 mm, tecnología PUR (Polyuretano reactivo). | Structure robustness. Humidity resistance. Estructura robusta. Resistente a la humedad. |
| DOORS PUERTAS | Hinges with brake. Bisagras con freno. | Soft close. Opening design for each design. Suavidad apertura / cierre silencioso. Soluciones de apertura para cada diseño. |
| INSTALLATION INSTALACIÓN | Hangers + wall plate made Italy. Compliance with all regulations and standards. Drain valves in faucet finishes: chrome, gold, white, black. Patented flexible siphon. Colgadores + placa de pared hecha en Italia. Cumplimiento de todas las normativas y estándares. Válvulas desagüe en acabados grifería: cromo, oro, blanco, negro. Sifón flexible patentado. | Reliability, safety installation. Design and combination with other elements. Maximize drawer space. Reduces costs and facilitates plumbing installation. Fiabilidad, seguridad instalación. Diseño y combinación con el resto de elementos. Maximiza el espacio del cajón. Reduce costes y facilita la instalación de fontanería. |
| LACQUERED FINISHES ACABADOS LACADOS | Double layered paint on laminated fiber. Soft matte finishes. Doble capa de pintura sobre fibra laminada. Acabados mate soft. | No aging. It looks like the first day. Hardness and resistance lacquered surface. No envejece. Mantiene aspecto como el primer día. Dureza y resistencia de superficies lacadas. |
| WOOD FINISHES ACABADOS MADERA | Latest technology laminates with synchronized grain. Laminados última tecnología con veta sincronizada. | Ultra natural realism. They improve the resistance and properties of the natural veneer. Ultrarealism natural. Mejoran la resistencia y las propiedades de la chapa natural. |

PUZZLE

MORE SPACE



BASE UNIT
MÓDULOS

50cm

FINISHES
ACABADOS



OAK WOOD

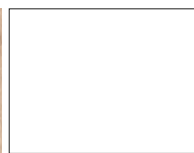

BLANCO SOFT



STORM GREY SOFT



BASIN
LAVABO

MX4

FINISHES
ACABADOS



MINERAL SOLID

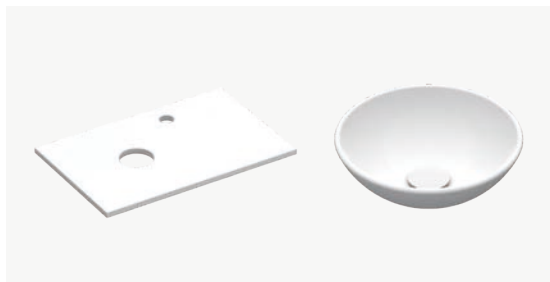

COUNTER + BASIN
ENCIMERA + LAVABO

50cm

FINISHES
ACABADOS



WHITE STONE



TORTORA STONE

PUZZLE

BASE UNIT 50 (20") ARMAZÓN 50 (20")

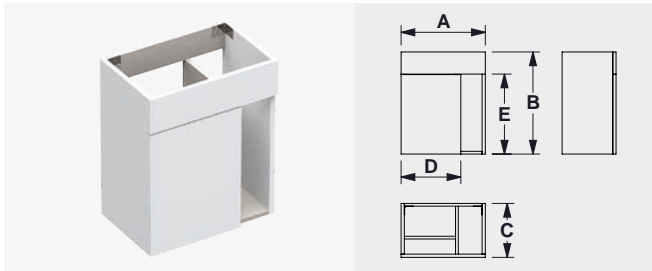

BLANCO SOFT
STORM GREY SOFT
OAKWOOD

Ref. 190133 A: 495 mm. B: 600 mm. C: 317 mm.
Ref. 190140 D: 351 mm. E: 470 mm.
Ref. 173075

Left door open push system.
Puerta apertura izquierda push.

MX4 BASIN 50 1Ø (20") MX4 ENCIMERA 50 1Ø (20")

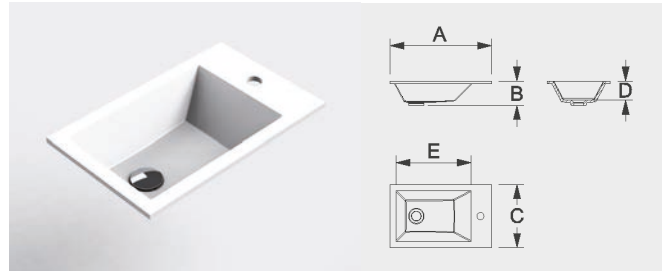

MINERAL SOLID®

Ref. 163809

A: 500 mm. B: 118 mm. C: 320 mm.
D: 92 mm. E: 370 mm.

Available with Ø0
Disponible en Ø0

MICROTECH COUNTER 500 MM. 1Ø (20") MICROTECH ENCIMERA 500 MM. 1Ø (20")

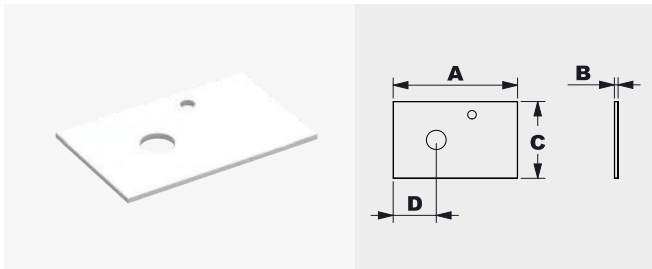

WHITE STONE
TORTORA STONE

Ref. 190157
Ref. 190164

A: 505 mm. B: 15 mm.
C: 320 mm. D: 175 mm.

SX12 BASIN CERAMIC Ø28 (11") SX12 LAVABO CERÁMICA Ø28 (11")

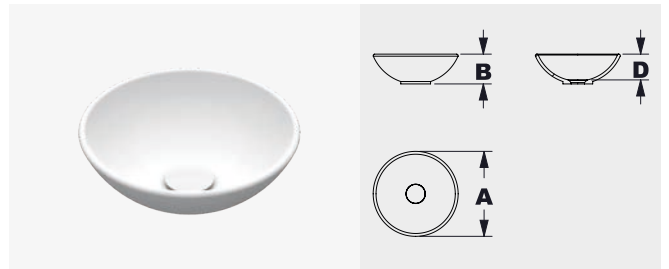

WHITE MATT
TORTORA MATT

Ref. 190171
Ref. 190188

A: 285 mm. B: 100 mm. D: 87 mm.

ADHESIVE TOWEL BAR 300 (12") TOALLERO BARRA ADHESIVO 300 (12")

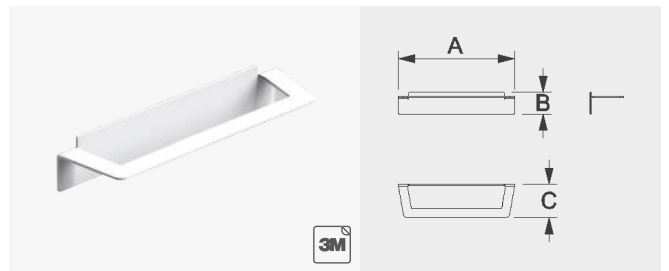

WHITE / BLANCO

Ref. 157365

A: 285 mm. B: 53 mm. C: 82 mm.

Adhesive fastening system.
Fijación adhesiva.

COMPLETE YOUR INSTALLATION COMPLETA TU INSTALACIÓN



TRAP
WASTEP-TRAP 1 1/4"
SIFÓN DESAGÜE 1 1/4"

CHROME / CROMO
Ref. 097388



CLICKER
PUSH DOWN
Ø 65 Mm. 1 1/4"
VÁLVULA CLICKER
Ø 65 Mm. 1 1/4"

CHROME Ref. 123940
WHITE Ref. 188895
TORTORA Ref. 188901



COUNTER + BASIN FINISH OPTIONS OPCIONES DE ACABADOS ENCIMERA + LAVABO



WHITE STONE



TORTORA STONE

BASE UNIT FINISH OPTIONS OPCIONES DE ACABADOS MUEBLE



BLANCO SOFT
Ref. 99922240



STORM GREY SOFT
Ref. 9992225E

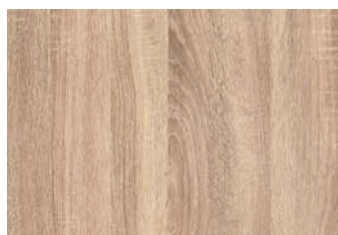

OAKWOOD
Ref. 9992225G

MIRA



MIRRORS & LIGHTS ESPEJOS & ILUMINACIÓN

| MIRRORS ESPEJOS | CM CM |
|--------------------|---------------------|
| BASIC | 80 90 100 120 |
| BASIC Ø | 60 80 |
| LLUNA Ø | 80 |
| NOVA Ø | 80 |
| ÉPOQUE | 81 |
| ALUGLASS | 80 90 100 120 |
| VORA | 80 90 100 |
| ALULIGHT | 80 100 120 |
| ALUMINIUM LIGTH | 80 100 120 |
| BACK LIGHT | 80 100 |
| CABINETS | 60 80 100 120 |

| LIGHTS LUCES | MM MM | FINISH ACABADO |
|-----------------|-----------------|-------------------|
| F09 LED | 515 | ALUMINIUM |
| F1 LED | 300 450 600 | CHROME |
| F12 | 300 | CHROME BLACK |
| F13 | 450 | CHROME |
| F14 | 600 | CHROME |
| F18 | 300 | CHROME |

Color temperature / Temperatura de color



Icon legend / Leyenda iconos

| | | | |
|---------------------|--------|----------|---------|
| Protection IP 20 | Zone 3 | Power | LED |
| Protection IP 44 | Zone 2 | Demister | Class 2 |

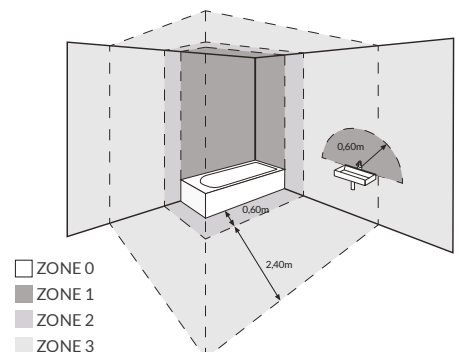

LED MIRRORS



LED MIRRORS



MIRA

| A (cm) | B (cm) | C (cm) | LED | ⏻ | 🔦 | Ref. |
|--------|--------|--------|-----|-----|-----|--------|
| 80 | 50 | 2 | Yes | No | No | 195602 |
| 80 | 60 | 2 | Yes | Yes | Yes | 195619 |

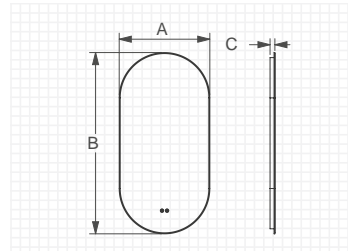

- Back LED light.
- Luz LED retroiluminado.



NOVA

| AØ (cm) | C (cm) | Watt | LM | ⏻ | 🔦 | Ref. |
|---------|--------|------|------|-----|-----|--------|
| 80 | 3 | 21,7 | 2170 | No | No | 184743 |
| 80 | 3 | 21,7 | 2170 | Yes | Yes | 195626 |

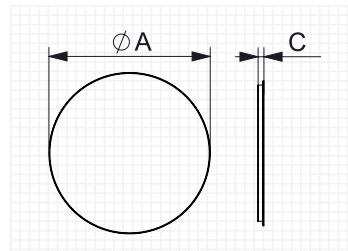

- Back LED light.
- 4mm beveled glass mirror.
- Luz LED retroiluminado.
- Luna biselada de 4 mm.

A++ **ZONE 2** **IP44** **IT** **5500°K**



VORA

| A (cm) | B (cm) | C (cm) | Watt | LM | LED | ⏻ | 🔦 | Ref. |
|--------|--------|--------|------|------|-----|-----|-----|--------|
| 90 | 45 | 2,5 | 24 | 2400 | Yes | No | No | 186488 |
| 90 | 45 | 2,5 | 24 | 2400 | Yes | Yes | Yes | 195633 |
| 80 | 60 | 2,5 | 24,6 | 2460 | Yes | No | No | 186471 |
| 80 | 60 | 2,5 | 24,6 | 2460 | Yes | Yes | Yes | 195640 |
| 100 | 80 | 2,5 | 32 | 3200 | Yes | No | No | 186495 |
| 100 | 80 | 2,5 | 32 | 3200 | Yes | Yes | Yes | 195657 |

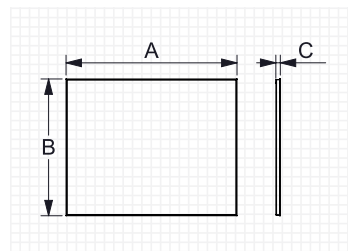

- Back LED light.
- 4mm beveled glass mirror.
- Horizontal and vertical fixation system.

- Luz LED retroiluminado.
- Luna biselada de 4 mm.
- Sistema de colocación horizontal y vertical.

A++ **ZONE 2** **IP44** **IT** **4200°K**

BASIC



MIRRORS / ESPEJOS



BASIC

| A (cm) | B (cm) | C (cm) | Ref. |
|--------|--------|--------|--------|
| 80 | 50 | 2 | 189816 |
| 80 | 60 | 2 | 154296 |
| 90 | 70 | 2 | 154302 |
| 100 | 40 | 2 | 119370 |
| 100 | 80 | 2 | 154319 |
| 120 | 80 | 2 | 189823 |

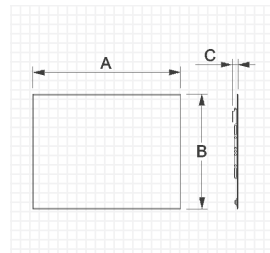

- 4mm beveled glass mirror.
- Horizontal and vertical fixation system.
- Luna biselada de 4 mm.
- Sistema de instalación vertical y horizontal.



BASIC

| AØ(cm) | C (cm) | Ref. |
|--------|--------|--------|
| 60 | 3 | 184835 |
| 80 | 3 | 184842 |

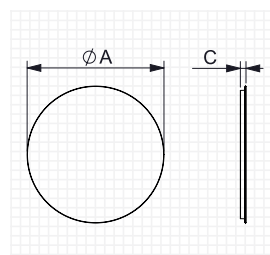

- 4mm polished edge glass.
- Luna canto pulido 4 mm.



DEMISTER KIT

| A (cm) | B (cm) | C (cm) | Ref. |
|--------|--------|--------|--------|
| 50 | 30 | 0,6 | 161980 |

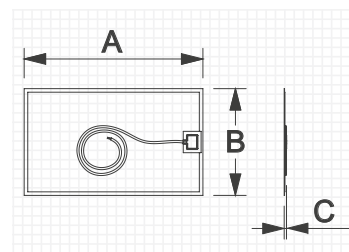

MIRRORS / ESPEJOS



ÉPOQUE

| A (cm) | B (cm) | C (cm) | Watt | LM | Ref. |
|--------|--------|--------|------|------|--------|
| 81 | 81 | 3 | 2400 | 2400 | 184729 |

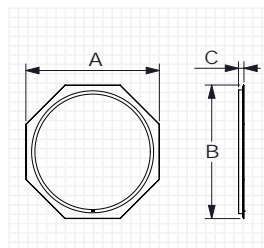

- Front LED light.
- 4mm beveled glass mirror.
- Luz LED frontal.
- Luna biselada de 4 mm.

A++ **ZONE 2** **IP44** **TI** **5500°K**



ALUGLASS

| A (cm) | B (cm) | C (cm) | Finish | Ref. |
|--------|--------|--------|--------|--------|
| 80 | 60 | 2,5 | ALU | 162000 |
| 80 | 60 | 2,5 | BLACK | 183654 |
| 100 | 70 | 2,5 | ALU | 162017 |
| 100 | 70 | 2,5 | BLACK | 189892 |
| 120 | 80 | 2,5 | ALU | 162024 |
| 120 | 80 | 2,5 | BLACK | 189908 |

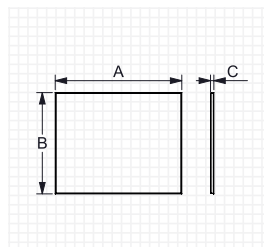

- Glass mirror with pvc aluminum frame.
- Horizontal and vertical fixation system.
- Luna con marco pvc de aluminio.
- Sistema de colocación horizontal y vertical.



LLUNA

| AØ (cm) | C (cm) | Watt | LM | Ref. |
|---------|--------|------|------|--------|
| 80 | 3 | 20,6 | 2060 | 184767 |

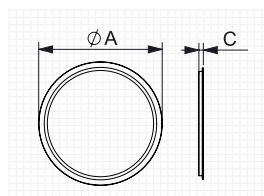

- Front LED light.
- 4mm beveled glass mirror.
- Luz LED frontal.
- Luna biselada de 4 mm.

A++ **ZONE 2** **IP44** **TI** **5500°K**

MIRRORS / ESPEJOS



ALULIGHT

| A (cm) | B (cm) | C (cm) | Watt | LM | Ref. |
|--------|--------|--------|------|------|--------|
| 80 | 60 | 2,5 | 4,3 | 430 | 164103 |
| 100 | 80 | 2,5 | 8,1 | 810 | 164110 |
| 120 | 80 | 2,5 | 10 | 1000 | 164127 |

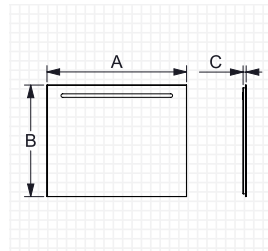

- Front LED light.
- 4mm beveled glass mirror.
- Horizontal and vertical fixation system.
- Luz LED frontal.
- Luna biselada de 4 mm.
- Sistema de colocación horizontal y vertical.

A++ ZONE 2 IP44 TT **5500°K**



ALUMINIUM LIGHT

| A (cm) | B (cm) | C (mm) | Watt | LM | Ref. | Finish |
|--------|--------|--------|------|------|--------|--------|
| 80 | 60 | 28 | 25 | 2112 | 161126 | ALU |
| 80 | 60 | 28 | 25 | 2112 | 189946 | BLACK |
| 100 | 80 | 28 | 33 | 1756 | 161133 | ALU |
| 100 | 80 | 28 | 33 | 1756 | 189953 | BLACK |
| 120 | 80 | 28 | 37 | 3072 | 168248 | ALU |
| 120 | 80 | 28 | 37 | 3072 | 189960 | BLACK |

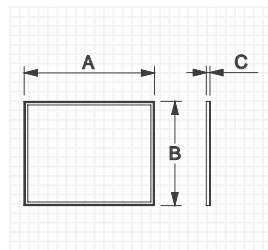

- Front LED light.
- Glass mirror with pvc aluminum frame.
- Horizontal and vertical fixation system.
- Luz LED frontal.
- Luna con marco pvc de aluminio.
- Sistema de colocación horizontal y vertical.

A++ ZONE 2 IP44 TT **5500°K**



BACK LIGHT

| A (cm) | B (cm) | C (cm) | Watt | LM | Ref. |
|--------|--------|--------|------|------|--------|
| 80 | 60 | 2,5 | 25 | 2112 | 161140 |
| 100 | 80 | 2,5 | 33 | 1756 | 161157 |

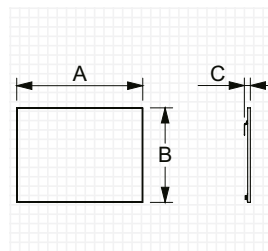

- Back LED light.
- 4mm beveled glass mirror.
- Horizontal and vertical fixation system.
- Luz LED retroiluminado.
- Luna biselada de 4 mm.
- Sistema de colocación horizontal y vertical.

A++ ZONE 2 IP44 TT **5500°K**

CABINETS





CABINET LED

| DOORS | A (cm) | B (cm) | C (cm) | LM | Watt | Ref. |
|-------|--------|--------|--------|-----|------|--------|
| 2 | 60 | 65 | 15 | 882 | 12W | 167258 |
| 2 | 80 | 65 | 15 | 882 | 12W | 167265 |
| 3 | 100 | 65 | 15 | 882 | 12W | 167272 |
| 3 | 120 | 65 | 15 | 882 | 12W | 167289 |

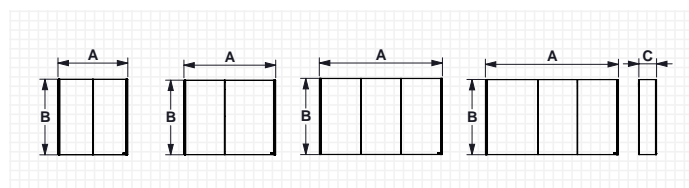

- Double glass mirror doors. (Interior / Exterior)
- Soft-close system.
- Adjustable glass shelf.
- Interior sock.
- Puertas de doble luna espejo. (Interior/Exterior).
- Cierre amortiguado.
- Estante de cristal regulable.
- Enchufe interior.

5500°K

LIGHTS

F09 LED



- Installation screwed or stuck on the mirror.
- Colocación: pegado o atornillado a espejo.
- Installation screwed for cabinet mirror.
- Colocación sobre espejo cabinet.

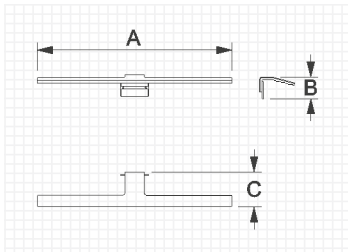

A++ ZONE 2 IP44 T1 9.6 WATT

5000°K

| MODEL | A (mm) | B (mm) | C (mm) | LM | Watt | Ref. |
|---------|--------|--------|--------|-----|------|--------|
| CABINET | 515 | 57 | 130 | 554 | 9.5 | 154531 |
| MIRROR | 515 | 57 | 93 | 554 | 9.5 | 154494 |

F1 LED



- Installation screwed or clipped on mirror, clip hardware included.
- Colocación atornillado al espejo o con pinza sobre luna.

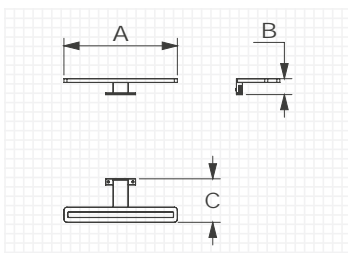

A++ ZONE 2 IP44 T1

6000°K

| A (mm) | B (mm) | C (mm) | LM | Watt | Ref. |
|--------|--------|--------|------|------|--------|
| 300 | 42 | 115 | 550 | 7 | 177585 |
| 450 | 42 | 115 | 600 | 7 | 177592 |
| 600 | 42 | 115 | 1275 | 17 | 177608 |

F12 - F13 - F14 - F18 LED



F12



F13



F14



F18

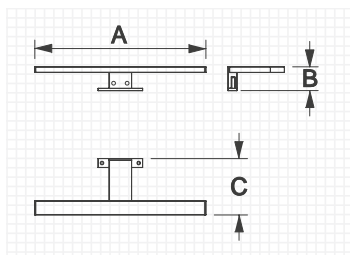

A++ **ZONE 2** **IP44** **TT** **6000°K**

- Installation screwed or clipped on mirror, clip hardware included.
- Colocación atornillado a espejo o con pinzas sobre luna. Pinza incl.

| MODEL | A (mm) | B (mm) | C (mm) | LM | W | Finish | Ref. |
|-------|--------|--------|--------|------|-----|--------|--------|
| F12 | 300 | 42 | 115 | 550 | 7 | CHROME | 162048 |
| F12 | 300 | 42 | 115 | 550 | 7 | BLACK | 189984 |
| F13 | 450 | 42 | 115 | 600 | 7 | CHROME | 162055 |
| F14 | 600 | 42 | 103 | 1275 | 14 | CHROME | 191277 |
| F18 | 300 | 42 | 115 | 400 | 5,4 | CHROME | 164288 |



GUARANTEE

Sonia guarantee is 10 years for accessory and 3 years for furniture, wash basins, mirrors, lighting and contract equipment. Always from the purchase date.

And only covering materials and manufacturing process defects.

The guarantee will not cover problems consequence of misuse, wrong maintenance, product modifications and the wear caused by normal use of the products.

In order to submit a claim the product, the original invoice and this document should be hand into the place you bought it.

Recomendations:

- Always clean with a cloth dampened with water and then dried.
- Do not use products or scouring pads that may damage the surface.
- Always follow the cleaning, maintenance and installation instructions you will find with each product.
- Use the product according to its functionality.

GARANTÍA

Sonia garantiza, a partir de la fecha de compra, por un periodo de 10 años de garantía en todos sus accesorios. Para la gama de muebles, lavabos, espejos, iluminación y artículos contract, el periodo de garantía será de 3 años.

Esta garantía cubre los problemas que tengan origen en defectos de fabricación o materiales.

La garantía no cubre los desperfectos ocasionados por el mal uso, mantenimiento indebido, modificaciones o reparaciones realizadas por terceros y el desgaste originado por el uso normal de los productos.

En caso de incidencia, deberá entregarse el producto en el establecimiento de compra acompañado de esta garantía y la factura de compra original.

Recomendaciones:

- Limpiar siempre con un paño humedecido con agua y posteriormente secar.
- No usar productos ni esponjas abrasivas que puedan dañar la superficie.
- Seguir siempre las indicaciones de limpieza, mantenimiento y montaje que incluya el producto.
- Hacer uso del producto según la naturaleza para la que ha sido diseñado.



QUALITY CALIDAD

With the commitment to continually improve its products, processes, services and systems, Sonia has implemented ISO 9001. This commitment is reflected in our Quality Policy, which provides a reference framework for establishing management objectives as well as guiding all its processes towards the satisfaction of business stakeholders:

Satisfaction of expectations of business stakeholders.

Continuous improvement of the Management System, Products, Services and Processes.

Compliance with legal, technical and market requirements.

Accomplishment of the goals

Integration of the value chain.

Furniture:

UNE EN 14749, Domestic and kitchen storage units and worktops - Safety requirements and test methods.

UNE 56867, Bathroom furniture. Testing of surface finishes.

UNE 56868, Bathroom furniture. Physical test methods.

Basins:

UNE 67001, Ceramic sanitary ware. Technical specifications.

UNE EN 31, Wash basins - Connecting dimensions.

UNE EN 14688, Sanitary appliances - Wash basins - Functional requirements and test methods.

Accessories:

UNE 67100, Bathroom accessories. Definitions, general characteristics and tests:

Corrosion tests:

UNE-EN-ISO 9227. Corrosion tests in artificial atmospheres - Salt spray tests.

EN-ISO 10289. Methods for corrosion testing of metallic and other inorganic coatings on metallic substrates - Rating of test specimens and manufactured articles subjected to corrosion tests.

Sonia standard test: 216 hours vs 96 hours as per the norm.

UNE-EN ISO 27874. Metallic and other inorganic coatings - Electrodeposited gold and gold alloy coatings for electrical, electronic and engineering purposes - Specification and test methods .

ISO 4524-2. Metallic coatings. Test methods for electrodeposited gold and gold alloys coatings. Part 2: Environmental tests.

Adhesion tests:

UNE-EN 248. Sanitary tapware - General specification for electrodeposited coatings of Ni-Cr.

UNE-EN ISO 27874. Metallic and other inorganic coatings - Electrodeposited gold and gold alloy coatings for electrical, electronic and engineering purposes - Specification and test methods.

UNE-EN ISO 2409. Paints and varnishes. Cross-cut test.

Sonia con el compromiso de mejorar continuamente sus productos, procesos, servicios y sistemas ha implementado la ISO 9001. Este compromiso se plasma en nuestra Política de Calidad que proporciona un marco de referencia para el establecimiento de los objetivos de gestión así como orientar todos sus procesos hacia la satisfacción de las partes interesadas del negocio:

Satisfacción de expectativas de las partes interesadas del negocio.

Mejora continua del Sistema de Gestión, Productos, Servicios y Procesos.

Cumplimiento de los requisitos legales, técnicos y de mercado.

Cumplimiento de los objetivos

Integración de la cadena de valor.

Mueble:

UNE EN 14749, Muebles contenedores y planos de trabajo para uso doméstico y en cocinas. Requisitos de seguridad y métodos de ensayo.

UNE 56867, Muebles de Baño ensayos de revestimientos superficiales.

UNE 56868, Muebles de Baño ensayos físicos.

Lavabos

UNE 67001, Aparatos sanitarios cerámicos. Especificaciones técnicas.

UNE EN 31, Lavabos. Cotas de conexión.

UNE EN 14688, Aparatos sanitarios. Lavabos. Requisitos funcionales y métodos de ensayo.

Accesorios

UNE 67100, Accesorios de baño. Definiciones, características generales y ensayos:

Ensayos de corrosión

UNE-EN-ISO 9227. Ensayos de corrosión en atmósferas artificiales. Ensayos de niebla salina.

EN-ISO 10289. Métodos de ensayo de corrosión de recubrimientos metálicos y no orgánicos sobre sustratos metálicos. Clasificación de probetas y piezas de protección sometidas a ensayos de corrosión.

Hacemos 216 horas de ensayo frente a las 96 que marca la norma.

UNE-EN ISO 27874. Recubrimientos metálicos y otros recubrimientos inorgánicos. Recubrimientos electrolíticos de oro y aleaciones de oro para usos eléctricos, electrónicos e industriales. Especificaciones y métodos de ensayo.

ISO 4524-2. Recubrimientos metálicos. Métodos de ensayo de los depósitos electrolíticos de oro y aleaciones de oro. Parte 2: ensayos climáticos.

Ensayos de Adherencia

UNE-EN 248. Grifería sanitaria. Especificaciones técnicas generales de los revestimientos electrolíticos de Ni-Cr.

UNE-EN ISO 27874. Recubrimientos metálicos y otros recubrimientos inorgánicos. Recubrimientos electrolíticos de oro y aleaciones de oro para usos eléctricos, electrónicos e industriales. Especificaciones y métodos de ensayo.

UNE-EN ISO 2409. Pinturas y barnices. Ensayo de corte por enrejado.

MAINTENANCE

Care & Maintenance Bathroom Accessories

Sonia Accessories are known and admired for the long lasting quality and intense gloss in their finish.

In order to maintain your Sonia accessories with its brand new luster, it is important to follow some simple instructions:

- Use only neutral non-abrasive detergents.
- It is recommended to use a soft cloth, do not use abrasive cleaners, steel wool or pads.
- Do not spray cleaning agents directly on the accessories under any circumstance, spray on the cloth, since spray liquid can come into openings or holes of the products and cause damages.
- The use of steam cleaners is not recommended since the extreme high temperature of steam can compromise the integrity of the coating finish of the product.

Furniture Maintenance

GENERAL INFORMATION FOR ALL SURFACES:

The beauty and the life of our wood finish products will endure for years depending on the care they receive.

Sonia furniture is manufactured using materials ideal for use in an often-humid bathroom environment. Nevertheless, in bath design, it is always important to ensure the furniture is placed at a clear distance from your bath or shower to avoid continuous direct splashes of water and soap residue. When splashed with water, wipe furniture dry on order to minimize the risk of damage.

Cleaning instructions:

- We recommend cleaning with a soft damp cloth and a mild all-purpose cleaning agent. (Spray the cleaning agent on to a damp cloth and wipe the surface. Never spray directly onto the furniture).
- We advise against vigorous rubbing as this may cause stains and damage.
- It is very important to keep the cabinet surfaces dry. Wipe up spills immediately using a dry cloth with a "blotting" motion, rather than wiping the spill from the cabinet surface. Pay special attention to areas where water is common, such as the sink and dishwasher, and do not allow water and detergents to dry on the cabinet surface.
- Wipe with a damp cloth wrung in clean water to remove the cleaning agent and to avoid stains and stripes.

• Avoid using dry cloths and paper tissue for furniture with matt and high-gloss surfaces, as these may scratch the surface.

• Do not use abrasive cleaning agents or cleaning agents that contain ammonia, bleach or other strong solvents as these will damage the furniture.

• Avoid excessive moisture. This is one of the worst enemies of any finish. Avoid draping wet towels over cabinet doors. Do not attach towel racks to door interiors. Immediately dry off any areas where water has spilled.

• Avoid excessive heat. Avoid placing cabinet appliances where the heat is directed onto cabinet surfaces. The stability of the wood and finish can be negatively impacted.

Final thoughts

Wood products and their finish are only as good as the care they receive. Proper care as recommended will extend the life and beauty of your cabinet. Remember, leaving water or other moisture on the cabinet surface for extended periods of time will harm the finish.

MANTENIMIENTO

Mantenimiento accesorios baño

Los accesorios de Sonia son admirados por su calidad y brillo intenso que perdura a lo largo de la vida.

Para que tus accesorios conserven el brillo del primer día es importante seguir unas sencillas instrucciones de mantenimiento:

- Usar sólo detergentes neutros no abrasivos.
- Es recomendable utilizar un paño suave, no utilizar utensilios abrasivos, esponjas metálicas o estropajos.
- No conviene rociar agentes limpiadores en ningún caso sobre los accesorios, sino sobre el paño, cualquier líquido pulverizado puede entrar en aperturas o hendiduras de los productos y causar daños.
- La utilización de limpiadores a vapor no está permitida, las altas temperaturas pueden dañar los productos.

Mantenimiento mobiliario

INFORMACION GENERAL PARA TODAS LAS SUPERFICIES:

La belleza de los productos acabados en madera permanecerá intacta durante años si les damos los cuidados adecuados.

La selección de materiales para los cuartos de baño de Sonia la hacemos cuidadosamente con los materiales adecuados para el uso en ambientes húmedos. Es conveniente, sin embargo, asegurarnos de que en su instalación guardamos una distancia de seguridad prudencial con la ducha o bañera para evitar salpicaduras directas o residuos de jabón, y en caso de que se produzcan proceder a secar el mueble para minimizar posibles daños.

Instrucciones de limpieza:

- Recomendamos limpiar su mueble con un paño suave y un limpiador multiusos no abrasivo. (Coloque el agente limpiador directamente en el paño y limpie entonces la superficie, por favor no dirija el pulverizador directamente hacia el mueble).
- Frótelo suavemente, el hacerlo

vigorosamente podría causar manchas o daños.

• Es muy importante mantener las superficies del mueble secas, le recomendamos poner atención en las zonas donde el agua es habitual, como zonas próximas al lavamanos, y secar con un paño los excesos de agua o jabones.

• En muebles con brillo le recomendamos no utilizar toallas de papel o paños secos que podrían rallar la superficie.

• No utilizar agentes abrasivos que contengan amoníaco, lejía o disolventes que puedan dañar la Madera.

• Los excesos de agua son los peores enemigos de la madera, evite limpiarlos por dentro o fuera con ninguna fuente directa de agua, y recordar siempre secar los excesos.

• Evite fuentes de calor directas, tipo limpiadores de vapor, hacia las superficies de su mueble.

Recuerde, el agua o cualquier líquido estancado en la superficie de su mueble dañaría el acabado y no estaría cubierto por ninguna garantía.

TRANSPORT GUARRANTIES

At Sonia we have a real passion for quality that is why we apply strict guidelines for each and every process, starting from the entry of the materials into our warehouses, all the way through to the shipment of the correctly packed goods. That way we can guarantee that our clients can continue to enjoy the beauty and quality of our products.

To facilitate this there is a time period, during the transport of the goods, where we will need your close collaboration in order to ensure the maximum quality of the products.

We expect you to examine the materials once you have received them in order to make sure that it was delivered to you in perfect condition, because we provide up to 48 hours to make a claim in case of damages:

1. If you are absolutely sure that the material was delivered in perfect condition, please sign the delivery note without any further remarks.
2. In the case of any issues, or if you are not able to properly examine the goods then please add the following text in the delivery note: "Damaged packaging".
3. In case of damage to the materials themselves, the delivery note should be marked with the text "Damaged goods".

By performing these easy steps, the transport agencies and the insurance companies will be able to respond quickly and effectively for any damage caused during transport, if not Sonia SA will not be held responsible for any replacement cost.

Please contact us via email:

sonia.export@sonia-sa.com (International)

sonia.nacional@sonia-sa.com (Spain/Portugal)

Many thanks for your kind cooperation,
Logistics department Sonia, S.A.

GARANTÍAS DE TRANSPORTE

En Sonia tenemos verdadera obsesión por la calidad, y así implementamos estrictos seguimientos en cada uno de los procesos, desde la entrada de las materias primas en nuestros almacenes, hasta la salida del producto, adecuadamente embalado para garantizar que nuestros clientes sigan disfrutando de la belleza y calidad de nuestros productos.

Hay un tramo, durante el transporte, en el que necesitamos vuestra estrecha colaboración para poder seguir garantizándoos la máxima calidad del producto:

1. Necesitamos que observéis la mercancía a su recepción para aseguraros de que llegó en perfectas condiciones, en este único caso, si estáis completamente seguros de que la mercancía llegó perfecta, por favor, firmad el albarán de entrega sin reserva.
2. En caso de duda, o de no poder examinarlo adecuadamente, añadir en el albarán la frase "embalaje dañado".
3. En caso de daño, tenemos como máximo 48 horas para reclamar, en el albarán evidenciar "mercancía dañada/rota".

Con estos simples pasos las empresas de transporte o los seguros se harán cargo de cualquier desperfecto durante el traslado.

Por favor, contactad vía e-mail:

sonia.export@sonia-sa.com (Fuera de territorio español)

sonia.nacional@sonia-sa.com (En España)

Muchas gracias por vuestra colaboración,
Departamento Logística Sonia, S.A.

SALES AND TERMS CONDITIONS

PRICES

Prices are subjected to change without notice and are exclusive of any shipping, delivery, packaging or handling charges that may apply.

DELIVERIES

Sonia S.A. will not be held responsible for delays in deliveries due to circumstances beyond its control such as fires, strikes, acts of nature, material shortages, accidents transportation delays, natural disasters or any other contingencies of such nature.

CLAIMS

All claims are to be made within 30 days after receipt of goods. **NO CLAIM WILL BE ACCEPTED AFTER THE 30 DAYS DEADLINE.** It is your responsibility to inspect the products once received, especially when the product is going to a job site. Notify carrier immediately in writing and request an inspection report, which shows the exact procedures for filing a claim. Keep all packaging material until your claim has been settled. Sonia S.A. has packaged the material to exceed normal shipping requirements and will not be responsible for poorly packaged returned fixtures resulting in additional damages. **DO NOT RETURN ANY MATERIAL WITHOUT WRITTEN CONSENT** from Sonia S.A. Seller's responsibility ceases when the products are delivered in good conditions to the carrier.

Replacements will only be shipped ground. If any other special shipment is required, customer will be responsible for additional charges.

180 DAY RETURN POLICY

Products may not be returned for credit or replacement without prior inspection and **WRITTEN AUTHORIZATION FROM Sonia S.A.** All R.G.A.'s must be requested in writing. The request must include P.O. number, invoice number (if available) and reason for return, after receiving your request, we will fax an approval that **MUST BE INCLUDED** with your return. Our restocking fee is 25%. In the event a product needs to be re-boxed for resale, we will charge a 15% net reboxing fee.

Orders including special order, project or display **CANNOT** be cancelled or returned.

WOOD PRODUCTS

A majority of our products are crafted from noble woods and various finishes. Because of the natural variations inherent to this natural material, minor differences in the look and finish are expected and are not considered manufacturing defects. We cannot guarantee an exact match on any of our products.

CONDICIONES GENERALES DE VENTA

1. Todos los pedidos se entenderán como compra en firme y estarán sujetos a la aprobación de nuestro Departamento Comercial.

2. El destinatario deberá comprobar que el material recibido, coincide con su pedido, y con el albarán que se adjunta. Así mismo deberá revisar que el material está en perfecto estado.

· Cualquier reclamación por rotura o daños en transporte deberá notificarse por escrito a Sonia, S.A. en las 24 horas siguientes a la entrega del material, de no ser así Sonia, S.A. no está obligada a reponer el material sin cargo.

· Las reclamaciones por diferencias en el material recibido, deberán realizarse en las 48 horas siguientes a la recepción del mismo.

3. Todos los pedidos superiores a 70€ se servirán a portes pagados.

Los pedidos inferiores a esta cantidad, quedarán retenidos hasta agruparlos a posteriores hasta superar el importe mínimo, a no ser que se indique lo contrario. De ser así irán cargados en factura 8€ en concepto de portes o enviados a portes debidos por la agencia que se nos indique.

Para el suministro de pedidos a portes pagados en Canarias:

- Tenerife y Las Palmas: Pedidos superiores a 1.000€.
- Lanzarote, Fuerteventura e Islas Menores: Pedidos superiores a 1.500€.
- Ceuta y Melilla: Pedidos superiores a 1.000€.

Toda reclamación efectuada después de 8 días ajena a motivos imputables a Sonia, S.A. no será atendida.

4. Todas las facturas inferiores a 60€ se emitirán con vencimiento 15 días independientemente del plazo de pago habitual.

5. Los precios que aparecen en la tarifa no incluyen el I.V.A., se incrementarán en todas las facturas el régimen general.

6. Devoluciones: No se admitirán devoluciones de mercancías que no hayan sido previamente notificadas por escrito y autorizadas por nuestro Dpto. Comercial.

No se admitirán devoluciones de artículos especiales.

Las devoluciones autorizadas se realizarán a través de nuestro transportista habitual.

No se admitirán cargos de otra empresa de transportes que no sea la autorizada.

El cliente se hará cargo de las devoluciones originadas por motivos ajenos a Sonia, S.A., previa autorización de nuestro Dpto. Comercial pudiendo elegir la agencia de transportes que estime oportuno para realizar dicha devolución, asegurándose de que el producto esté en buenas condiciones y sea embalado correctamente para su transporte.

La mercancía deberá venir acompañada de una hoja con la relación del material autorizado; en caso contrario Sonia, S.A. podría no hacerse cargo de la mercancía.

Una vez recepcionada y aceptada, se expedirá la factura de abono correspondiente con una depreciación del 20% sobre el importe facturado, en concepto de manipulación, revisión y cambio de embalaje del producto devuelto, dicha cantidad será descontada en futuras compras.

7. Impagados:

Cualquier impagado que se produzca traerá como consecuencia la comunicación del mismo a nuestra compañía de Riesgo y la retención de los pedidos en curso hasta no tener cancelado dicho impagado.

Sonia, S.A. es el propietario de la mercancía hasta el pago completo de la misma.

8. Tribunales:

En caso de litigio ambas partes se someten a los tribunales de Valencia, rehusando a los que le correspondiesen por fuero propio.

9. Aceptación:

El hecho de cursar un pedido a Sonia, S.A. implica la aceptación de estas condiciones generales de venta.

10. Sonia, S.A. se reserva el derecho de modificar el diseño para mejora de sus productos.

11. Todos nuestros productos podrán ser modificados por exigencias de diseño y calidad sin previo aviso.

Toda la documentación fotográfica y/o diseño técnico reflejada en los folletos, catálogos y demás instrumentos publicitarios tienen valor indicativo, por lo que el cliente no podrá acogerse a ellos en caso de posibles quejas por disconformidad o diferencia con los productos suministrados siempre y cuando no afecte al uso que al que va destinado el producto. Todas las reclamaciones derivadas por este motivo, deberán realizarse con un plazo máximo de 7 días siguientes a la entrega de la mercancía en su lugar de destino.



Prices show in this catalogue are valid except for typographical errors.
Los precios indicados en este catálogo son válidos salvo error tipográfico.

Edition 1.2
Edición 1.2



SONIA
Valencia - Spain
www.soniabath.com
© 2022 Sonia, S.A.

CONTACT
T. 96 317 10 68
F. 96 317 11 61
sonia.nacional@soniabath.com

INTERNATIONAL
T. +34 96 317 10 67
F. +34 96 317 10 69
sonia.export@soniabath.com