

20

NAVARTI
cerámica

24



ES

Desde 2014 y con más de 20 años de experiencia en el sector, Navarti Cerámica trabaja día a día en construir unos fuertes valores basados en el diseño, la innovación y la calidad de nuestro producto. Todo esto unido a una atención al cliente de calidad junto con una fuerte presencia en el mercado tanto a nivel nacional como internacional.

Gracias al avance de nuestras tecnologías y a un equipo proactivo e inconformista, Navarti es sinónimo de evolución y buen gusto. El compromiso medioambiental nos define, ya que utilizamos procesos de fabricación que simplifican de manera significativa la huella de carbono en el planeta Tierra. Y como muestra de ello, poseemos diversos certificados, en los cuales se reconocen estrategias y prácticas de construcción sostenible, saludables y altamente eficientes.

En este catálogo, a través de la amplia variedad de colecciones que presentamos, buscamos satisfacer todo tipo de gustos y necesidades. Todo ello gracias al multiformato, a los distintos acabados y reproducciones altamente fieles a los materiales reales.

Pero sobre todo, queremos servir de inspiración y poder acompañar a las personas en su proyecto de vida.

EN

Since 2014 and with more than 20 years of experience in the sector, Navarti Cerámica works every day to build strong values based on the design, innovation and quality of our product. All this coupled with quality customer service together with a strong presence in the market both nationally and internationally.

Thanks to the advancement of our technologies and a proactive and non-conformist team, Navarti is synonymous with evolution and good taste. Our environmental commitment defines us, as we use manufacturing processes that significantly simplify the carbon footprint on planet Earth. And as proof of this, we have various certificates, in which sustainable, healthy and highly efficient construction strategies and practices are recognized.

In this catalogue, through the wide variety of collections that we present, we seek to satisfy all kinds of tastes and needs. All this thanks to the multi-format, the different finishes and reproductions highly faithful to real materials.

But above all, we want to serve as inspiration and be able to accompany people in their life project.

ES

Navarti Cerámica cuenta con un sistema de gestión ambiental para identificar y minimizar el impacto de sus operaciones sobre las emisiones atmosféricas, aguas residuales, residuos y contaminación acústica.

La compañía está comprometida con el cumplimiento de las disposiciones legales en material medioambiental. Navarti cuenta con la Autorización Ambiental Integrada, otorgada por la Conselleria de Territorio y Vivienda de la Generalitat Valenciana. Aparte, aplicando criterios de mejora continua, lleva a cabo una valorización interna de los residuos y una recogida selectiva de los mismos como cartón, plástico o madera.

Otro input que Navarti tiene en cuenta, es el compromiso con la mejora en la gestión del agua, basada en los principios de reutilización y optimización de la misma en diferentes procesos. Además, apuesta por la aplicación constante de criterios de eficiencia energética en sus instalaciones y actividades. La compañía cuenta con Declaraciones Ambientales de Producto (DAP) para todas las familias de producto que comercializa. Una declaración concedida por Aenor en 2014 y ampliada en 2015 que destaca productos respetuosos con el medio ambiente.

EN

Navarti Cerámica has an environmental management system to identify and minimize the impact of its operations on atmospheric emissions, wastewater, waste and noise pollution.

The company is committed to complying with legal provisions on environmental matters. Navarti has the Integrated Environmental Authorization, granted by the Department of Territory and Housing of the Generalitat Valenciana. In addition, applying criteria of continuous improvement, it carries out an internal recovery of waste and a selective collection of the same as cardboard, plastic or wood.

Another input that Navarti takes into account is the commitment to improving water management, based on the principles of reuse and optimization of it in different processes. In addition, it is committed to the constant application of energy efficiency criteria in its facilities and activities. The company has Environmental Product Declarations (DAP) for all the product families it markets. A statement granted by Aenor in 2014 and extended in 2015 that highlights environmentally friendly products.



NOMBRE DE LA COLECCIÓN
Collection

INFO DE LA SERIE
Series info

IMÁGEN DE LA SERIE
Image series

ASPECTO DEL MATERIAL
Material Appearance

FORMATOS
Sizes

TIPOLOGÍA DE PRODUCTO
Product Series

COLORES
Colours

EMBALAJE
Packing

CÓDIGO DE PRECIO
Price Code

PIEZAS ESPECIALES
Special pieces

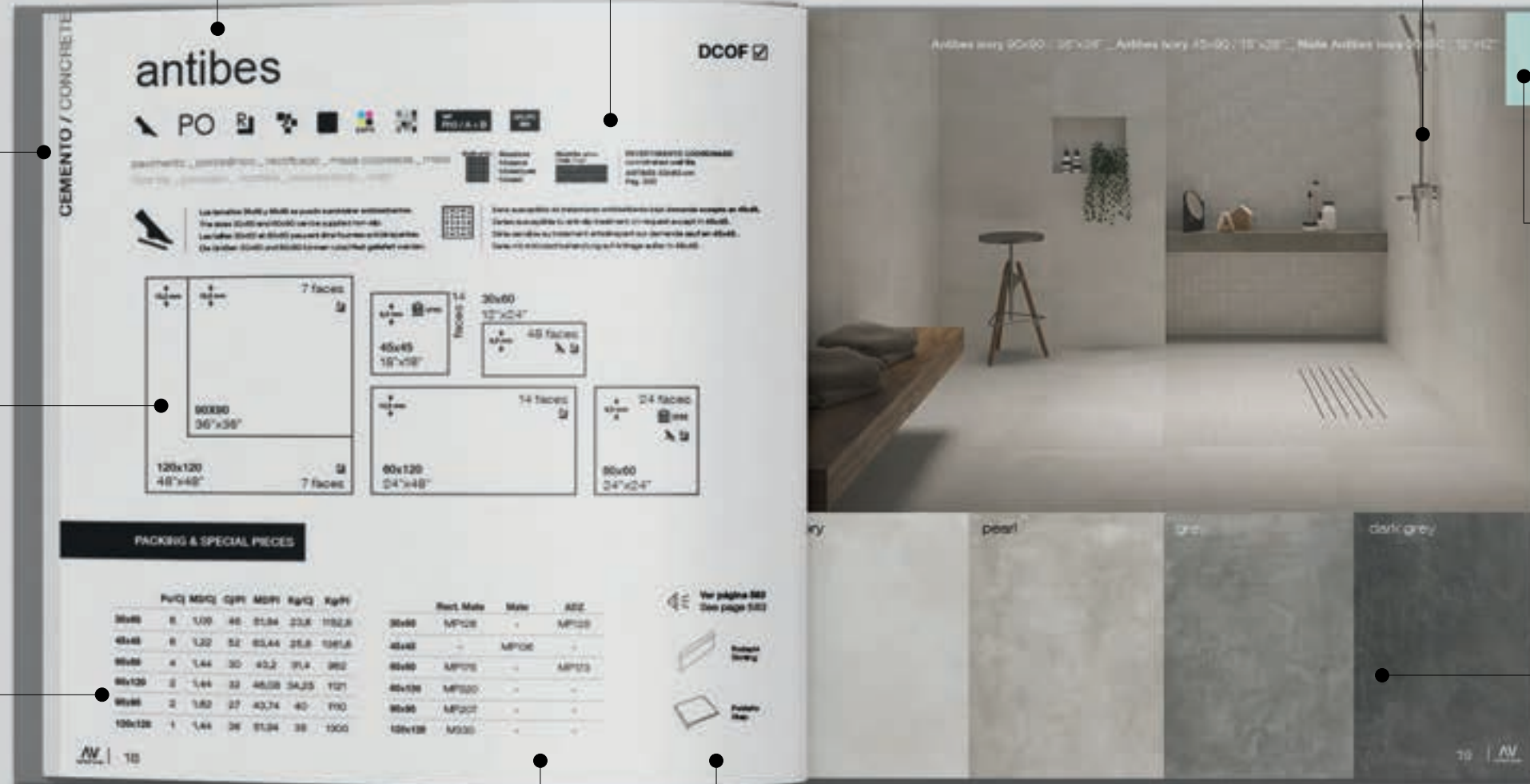

SIMBOLOGY



Revestimiento /
Wall Tiles



Pavimento /
Floor Tiles



Pavimento ADZ /
ADZ Floor Tile



Pavimento ADZ bajo demanda /
ADZ Floor Tile on request



Mate /
Matt



Pulido /
Polished



Granilla pulida /
Highly Polished



Brillo /
Gloss



Lappato /
Lappato



Masa coloreada /
Colored body



Digital /
Digital



Rectificado /
Rectified



Pasta Blanca /
White body



Pasta roja /
Red body



Porcelánico /
Porcelain



Sugar Lappato



Polimat /
Polimat



Glossy Ink /
Tinta brillo



Variación leve /
Slight variation



Variación moderada /
Moderate variation



Variación alta /
Strong variation



No trabado mitad de pieza /
Not brick-jointed halfway

SIMBOLOGÍA

TECHNICAL PORCELAIN
Porcelánico Masa Coloreada

14

70

20MM THICKNESS
20mm espesorado

HIGHLY POLISHED
Granilla Pulida

78

92

GLOSSY INK
Tinta brillo

POLIMAT
Polimat

98

104

LAPPATO
Lapado

POLISHED PORCELAIN
Porcelánico Pulido

118

212

WOOD PORCELAIN
Porcelánico Maderas

XTRA
6,8 mm

236

256

GLAZED PORCELAIN
Porcelánico Esmaltado

6 MM
6 mm

306

314

WHITE BODY WALL TILE
Revest. Pasta Blanca

RED BODY FLOOR TILE
Pav. Pasta Roja

358

374

RED BODY WALL TILE
Revest. Pasta Roja



Index table listing ceramic products (AERIS, ALLURE, ALYSA, AMYR, ANNIE, ANTIBES, ARTAN, ARTY, ATELERI, ATTIS, AURA, AVART, AZUR, BABYLON, BARROW, BASIL, BELGRAVIA, BELLAGIO, BELLAGIO GOLD, BERLÍN, BETHEL, BIRD, BLANCOS, BOLZANO, BOSCO, BRUCE, BUTÁN, BYRON, BYRONBAY, CAELUM, CALACATTA, CALCARE, CARRA, CEDAR, CERES, CHRISTY, CLOTHY, CONVEC) with their corresponding color-coded tile size and finish specifications.

Index table listing ceramic products (DAFFEN, DAFNE, DECK, DRAVA, DUOMO, DYLON, ECCHIO, ELDER, ETHAN, FANLO, FLAT, FOLK, FOREST, FORESTA, FORUM, FUSTA, GARI, GERHY, GIVET, GLOSSY COLL., GOLDEN, GRAIN STONE, GREECE, GUALDO, INKA, IRIS, JAYA MATT, KAMEN, KENDALL, KEON, LANCE, LAOS, LENGO, LINDSAY, LITHOS, LUGANO, MADEIRA, MAKAI, MANHATTAN) with their corresponding color-coded tile size and finish specifications.

ES

El porcelánico técnico se produce utilizando arcillas finas y minerales, que se someten a un proceso de cocción a temperaturas extremadamente altas. Esto da como resultado una baldosa muy densa y resistente, con baja porosidad.

EN

Technical porcelain is produced using fine clays and minerals, which are subjected to a firing process at extremely high temperatures. This results in a very dense tile and resistant, with low porosity.

FR

La porcelaine technique est produite à partir d'argiles fines et de minéraux soumis à un processus de cuisson à des températures extrêmement élevées. Il en résulte un carreau très dense et résistant, avec une faible porosité.

DE

Technisches Porzellan wird aus feinen Tonen und Mineralien hergestellt, die einem Brennprozess bei extrem hohen Temperaturen unterzogen werden. Dadurch entsteht eine sehr dichte und widerstandsfähige Fliese mit geringer Porosität.

TP

TECHNICAL PORCELAIN

ANTIBES • CALCARE • ECCHIO • GERHY • GRAIN STONE • INKA
METHOD • MYLOS • OXYDE • STREET • VALDIVIA • ZANZIBAR • ZIRO

antibes



Antibes ivory 60x120 / 24"x48" _ 60x60 / 24"x24"

antibes

DCOF



pavimento _ porcelánico _ rectificado _ masa coloreada _ mate
 floor tile _ porcelain _ rectified _ colored body _ matt



Mosaicos
 Mosaics
 Mosaïques
 Mosaik

REVESTIMIENTO COORDINADO
 coordinated wall tile
ANTIBES 30X60 cm
 Pág. 328



Los tamaños 30x60 y 60x60 se puede suministrar antideslizantes.
 The sizes 30x60 and 60x60 can be supplied non-slip.
 Les tailles 30x60 et 60x60 peuvent être fournies antidérapantes.
 Die Größen 30x60 und 60x60 können rutschfest geliefert werden.



Serie susceptible de tratamiento antideslizante bajo demanda excepto en 45x45.
 Series susceptible to anti-slip treatment on request except in 45x45.
 Série sensible au traitement antidérapant sur demande sauf en 45x45.
 Serie mit Antirutschbehandlung auf Anfrage außer in 45x45.

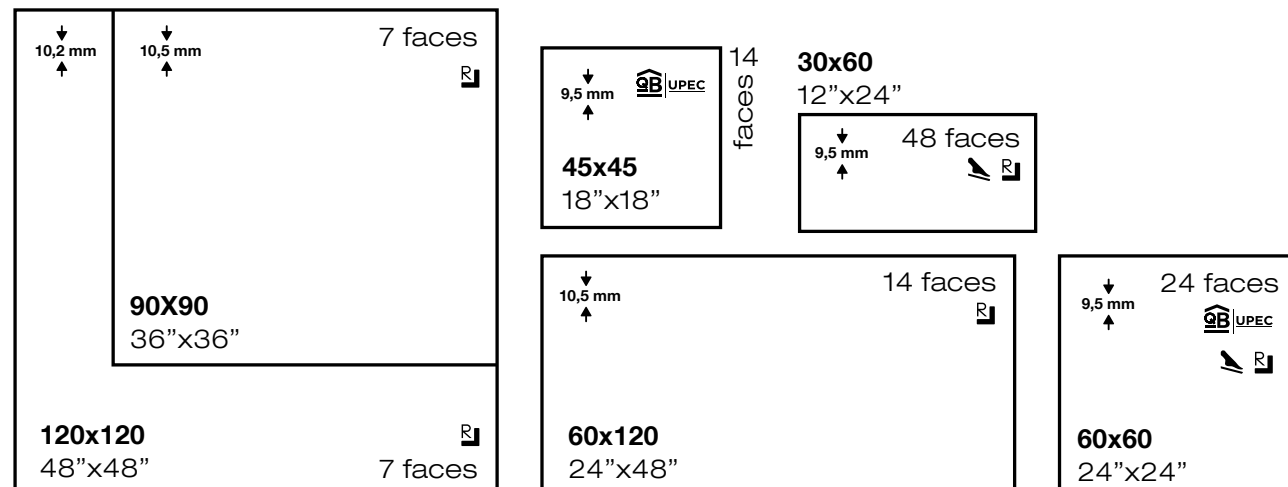

Antibes pearl 120x120 / 48"x48"

PACKING & SPECIAL PIECES

	Pc/Cj	M2/Cj	Cj/Pl	M2/Pl	Kg/Cj	Kg/Pl
30x60	6	1,08	48	51,84	23,6	1152,8
45x45	6	1,22	52	63,44	25,8	1361,6
60x60	4	1,44	30	43,2	31,4	962
60x120	2	1,44	32	46,08	34,25	1121
90x90	2	1,62	27	43,74	40	1110
120x120	1	1,44	36	51,84	35	1300

	Rect. Mate	Mate	ADZ
30x60	MP126	-	MP125
45x45	-	MP136	-
60x60	MP175	-	MP173
60x120	MP320	-	-
90x90	MP207	-	-
120x120	MP330	-	-

Ver página 428
 See page 428

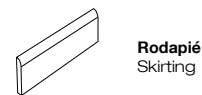

Rodapié
 Skirting

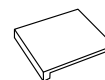

Peldaño
 Step

ivory pearl grey dark grey

ziro



Ziro gris 120x120 / 48"x48"

ziro

DCOF



pavimento _ porcelánico _ rectificado _ masa coloreada _ mate _ lappato
 floor tile _ porcelain _ rectified _ colored body _ matt _ lappato



Mosaicos
 Mosaics
 Mosaïques
 Mosaik

REVESTIMIENTO COORDINADO
 coordinated wall tile
ZIRO 30X60 / 36X80 cm
 Pág. 330 / 332



Los tamaños 30x60 y 60x60 se puede suministrar antideslizantes.
 30x60 and 60x60 sizes from collection can be produced on antislip finish.
 Les tailles 30x60 et 60x60 peuvent être fournies antidérapantes.
 Die Größen 30x60 und 60x60 können rutschfest geliefert werden.



Serie susceptible de tratamiento antideslizante bajo demanda excepto en 45x45.
 Series susceptible to anti-slip treatment on request except in 45x45.
 Série sensible au traitement antidérapant sur demande sauf en 45x45.
 Serie mit Antirutschbehandlung auf Anfrage außer in 45x45.

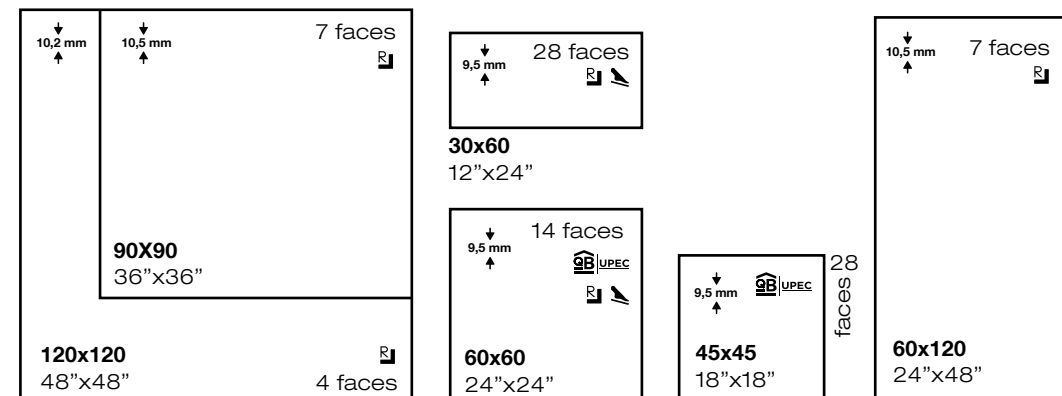

* dc tinsel

Revestimiento / Decorado de la serie.
 Wall tile / Deco from the series.
 Enrobage / Décoré de la série.
 Wandfliesen / Dekoriert aus der Serie.



P805

PACKING & SPECIAL PIECES

	Pc/Cj	M2/Cj	Cj/PI	M2/PI	Kg/Cj	Kg/PI
30x60	6	1,08	48	51,84	23,6	1152,8
45x45	6	1,22	52	63,44	25,8	1361,6
60x60	4	1,44	30	43,2	31,4	962
60x120	2	1,44	32	46,08	34,25	1121
90x90	2	1,62	27	43,74	40	1110
120x120	1	1,44	36	51,84	35	1300

	Mate Rect.	ADZ	Lappato	Mate
30x60	MP126	MP125	MP123	-
45x45	-	-	-	MP136
60x60	MP175	MP173	MP172	-
60x120	MP320	-	MP321	-
90x90	MP207	-	MP203	-
120x120	MP330	-	MP331	-

Ver página 428
 See page 428



Rodapié
 Skirting

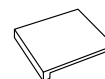

Peldaño
 Step



Ziro gris 60x60 / 24"x24" _ Rlv Kata gris 36x80 / 14"x32"

blanco

crema

perla

gris

marengo

mylos



Mylos bone 120x120 / 48"x48"

mylos

DCOF



pavimento _ porcelánico _ rectificado _ mate
 floor tile _ porcelain _ rectified _ matt

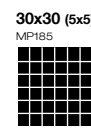

Mosaicos
 Mosaics
 Mosaïques
 Mosaik

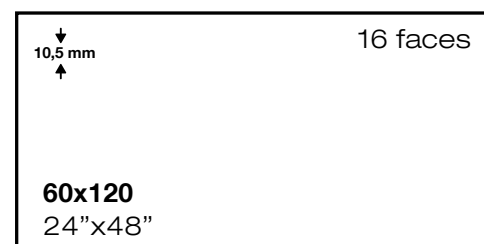
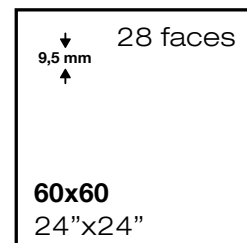
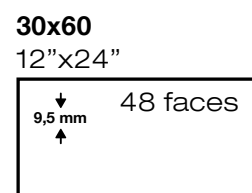
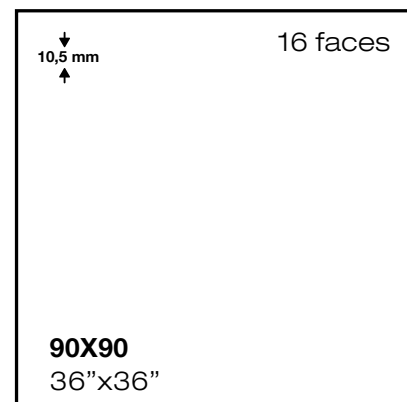
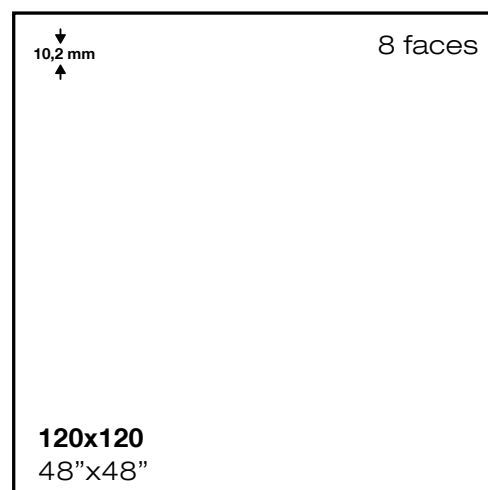

PACKING & SPECIAL PIECES

	Pc/Cj	M2/Cj	Cj/PI	M2/PI	Kg/Cj	Kg/PI
30x60	6	1,08	48	51,84	23,6	1152,8
60x60	4	1,44	30	43,2	31,4	962
60x120	2	1,44	32	46,08	34,25	1121
90x90	2	1,62	27	43,74	40	1110
120x120	1	1,44	36	51,84	35	1300

	Rect.	Mate
30x60	MP126	
60x60	MP175	
60x120	MP320	
90x90	MP207	
120x120	MP330	

Ver página 428
 See page 428



Rodapié
 Skirting

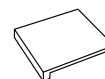

Peldaño
 Step

Mylos grey 90x90 / 36"x36"



bone

beige

grey

grafito

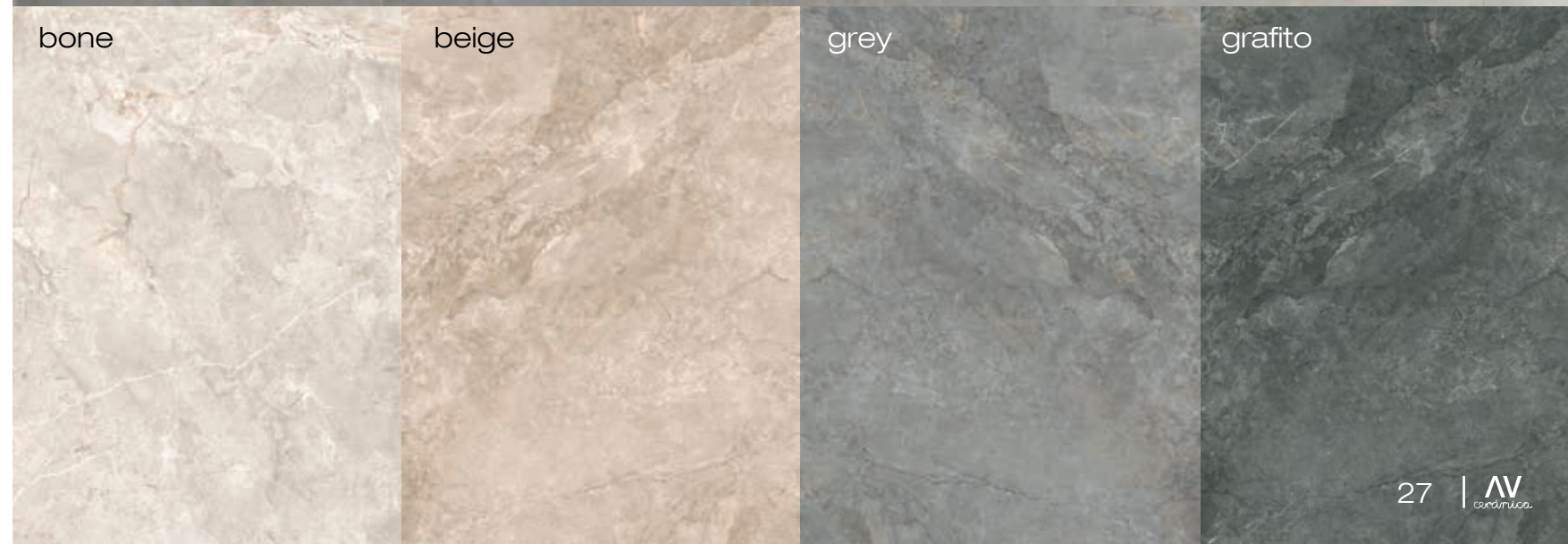

ecchio



Ecchio crema 120x120 / 48"x48

ecchio

DCOF



pavimento _ porcelánico _ rectificado _ masa coloreada _ mate
 floor tile _ porcelain _ rectified _ colored body _ matt



Serie susceptible de tratamiento antideslizante bajo demanda.
 Series susceptible to anti-slip treatment on request.
 Série sensible au traitement antidérapant sur demande.
 Serie mit Antirutschbehandlung auf Anfrage.

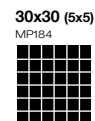

Mosaicos
 Mosaics
 Mosaïques
 Mosaik

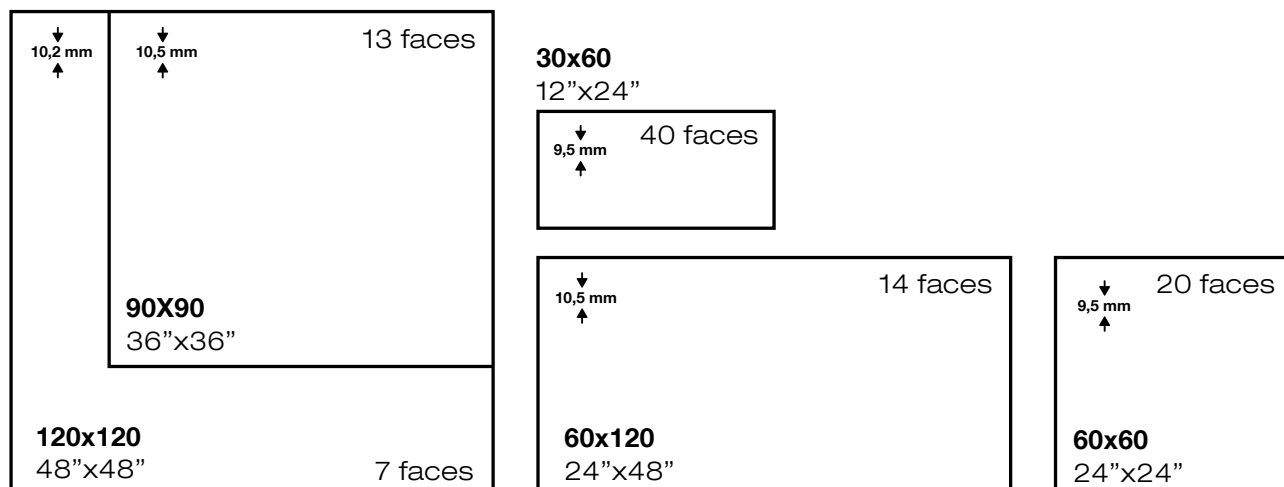

PACKING & SPECIAL PIECES

	Pc/Cj	M2/Cj	Cj/PI	M2/PI	Kg/Cj	Kg/PI		Mate
30x60	6	1,08	48	51,84	23,6	1152,8	30x60	MP182
60x60	4	1,44	30	43,2	31,4	962	60x60	MP177
60x120	2	1,44	32	46,08	34,25	1121	60x120	MP325
90x90	2	1,62	27	43,74	40	1110	90x90	MP206
120x120	1	1,44	36	51,84	35	1300	120x120	MP335

Ver página 428
 See page 428



Rodapié
 Skirting

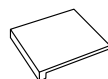

Peldaño
 Step

Ecchio crema 60x120 / 24"x48" _ Ecchio crema 120x120 / 48"x48" _ Mosaico Ecchio crema 30x30 / 12"x12"



crema

perla

taupe

gris

marengo

street



Street dark 120x120 / 48"x48" _ Street silver 60x120 / 24"x48"

street

DCOF



pavimento _ porcelánico _ rectificado _ masa coloreada _ mate
 floor tile _ porcelain _ rectified _ colored body _ matt



Serie susceptible de tratamiento antideslizante bajo demanda.
 Series susceptible to anti-slip treatment on request.
 Série sensible au traitement antidérapant sur demande.
 Serie mit Antirutschbehandlung auf Anfrage.

30x30 (5x5)
 MP184



Mosaicos
 Mosaics
 Mosaïques
 Mosaik

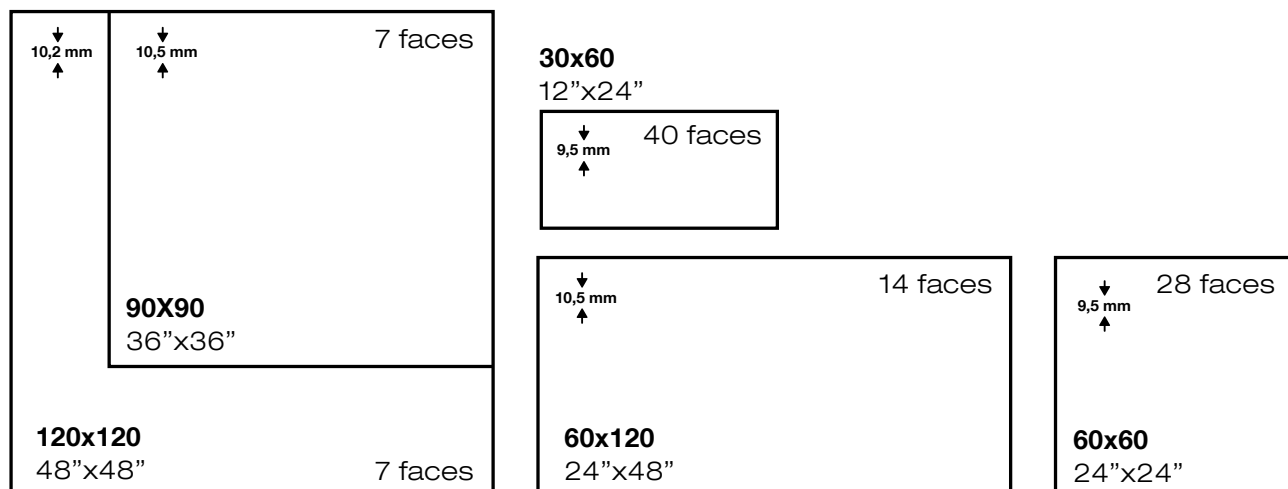

Street beige 60x120 / 24"x48"

PACKING & SPECIAL PIECES

	Pc/Cj	M2/Cj	Cj/PI	M2/PI	Kg/Cj	Kg/PI
30x60	6	1,08	48	51,84	23,6	1152,8
60x60	4	1,44	30	43,2	31,4	962
60x120	2	1,44	32	46,08	34,25	1121
90x90	2	1,62	27	43,74	40	1110
120x120	1	1,44	36	51,84	35	1300

	Rect. Mate
30x60	MP182
60x60	MP177
60x120	MP325
90x90	MP206
120x120	MP335

Ver página 428
 See page 428



Rodapié
 Skirting

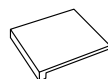

Peldaño
 Step



calcare



Calcare grey 120x120 / 48"x48"

calcare

DCOF



pavimento _ porcelánico _ rectificado _ masa coloreada _ mate
 floor tile _ porcelain _ rectified _ colored body _ matt



Serie susceptible de tratamiento antideslizante bajo demanda.
 Series susceptible to anti-slip treatment on request.
 Série sensible au traitement antidérapant sur demande.
 Serie mit Antirutschbehandlung auf Anfrage.

30x30 (5x5)
 MP184



Mosaicos
 Mosaics
 Mosaïques
 Mosaik

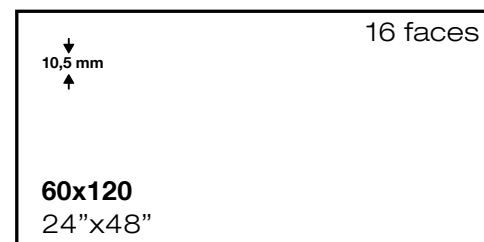
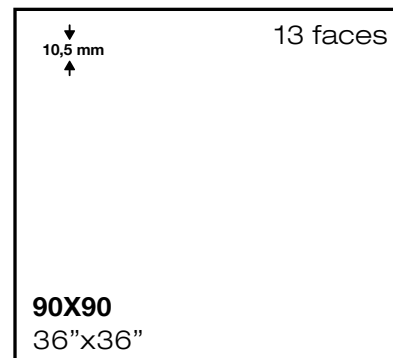
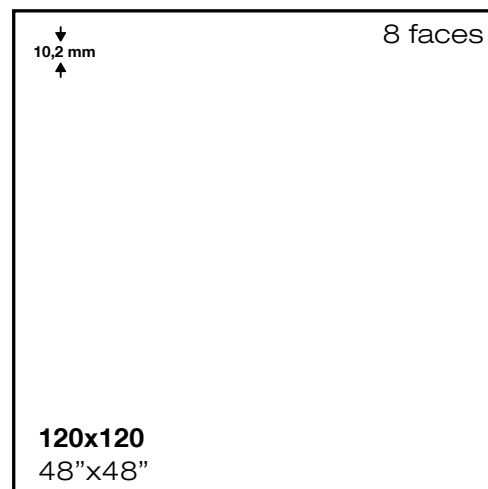

PACKING & SPECIAL PIECES

	Pc/Cj	M2/Cj	Cj/PI	M2/PI	Kg/Cj	Kg/PI
60x120	2	1,44	32	46,08	34,25	1121
90x90	2	1,62	27	43,74	40	1110
120x120	1	1,44	36	51,84	35	1300

	Rect.
60x120	MP320
90x90	MP207
120x120	MP330

Ver página 428
 See page 428



Rodapié
 Skirting

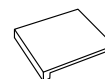

Peldaño
 Step



Calcare bone 90x90 / 36"x36"

bone

cream

pearl

grey

grain stone

Grain stone black 90x90 / 36"x36" _ Grain stone black 30x60 / 12"x24" _ Mosaic Grain stone black 30x30 / 12"x12

grain stone

DCOF



pavimento _ porcelánico _ rectificado _ masa coloreada _ mate
 floor tile _ porcelain _ rectified _ colored body _ matt



Serie susceptible de tratamiento antideslizante bajo demanda excepto en 45x45.
 Series susceptible to anti-slip treatment on request except in 45x45.
 Série sensible au traitement antidérapant sur demande sauf en 45x45..
 Serie mit Antirutschbehandlung auf Anfrage außer in 45x45.

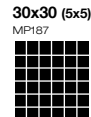

Mosaicos
 Mosaics
 Mosaïques
 Mosaik

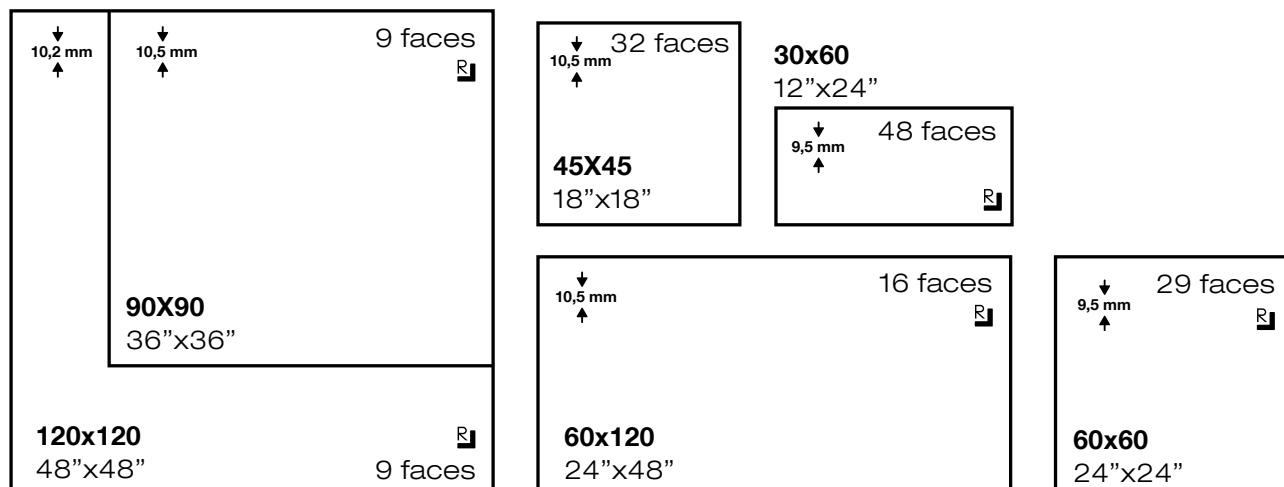

Grain stone sand 120x120 / 48"x48"

PACKING & SPECIAL PIECES

	Pc/Cj	M2/Cj	Cj/PI	M2/PI	Kg/Cj	Kg/PI
30x60	6	1,08	48	51,84	23,6	1152,8
45x45	6	1,22	52	63,44	25,8	1361,6
60x60	4	1,44	30	43,2	31,4	962
60x120	2	1,44	32	46,08	34,25	1121
90x90	2	1,62	27	43,74	40	1110
120x120	1	1,44	36	51,84	35	1300

	Rect. Mate	Mate
30x60	MP126	-
45x45	-	MP132
60x60	MP175	-
60x120	MP320	-
90x90	MP207	-
120x120	MP330	-

Ver página 428
 See page 428



Rodapié
 Skirting

Peldaño
 Step



sand

pearl

silver

black

inka



Inka grey 60x60 / 24"x24" _ Mosaico Inka grey 30x30 / 12"x24"

inka

DCOF



pavimento _ porcelánico _ rectificado _ masa coloreada _ mate
 floor tile _ porcelain _ rectified _ colored body _ matt



Serie susceptible de tratamiento antideslizante bajo demanda.
 Series susceptible to anti-slip treatment on request.
 Série sensible au traitement antidérapant sur demande.
 Serie mit Antirutschbehandlung auf Anfrage.

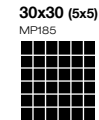

Mosaicos
 Mosaics
 Mosaïques
 Mosaik

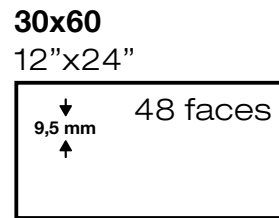
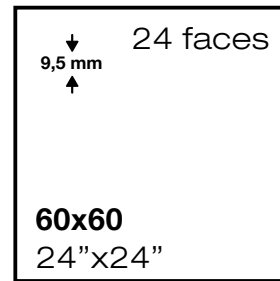

PACKING & SPECIAL PIECES

	Pc/Cj	M2/Cj	Cj/PI	M2/PI	Kg/Cj	Kg/PI
30x60	6	1,08	48	51,84	23,6	1152,8
60x60	4	1,44	30	43,2	31,4	962

	Mate
30x60	MP126
60x60	MP175

Ver página 428
 See page 428

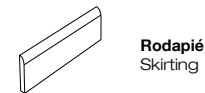

Rodapié
 Skirting

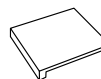

Peldaño
 Step

Inka white 60x60 / 24"x24 _ 30x60 / 12"x24"



white

beige

silver

grey

valdivia



Valdivia gris 120x120 / 48"x48"

valdivia

DCOF



pavimento _ porcelánico _ rectificado _ masa coloreada _ mate
 floor tile _ porcelain _ rectified _ colored body _ matt

 **Serie susceptible de tratamiento antideslizante bajo demanda.**
 Series susceptible to anti-slip treatment on request.
 Série sensible au traitement antidérapant sur demande.
 Serie mit Antirutschbehandlung auf Anfrage.

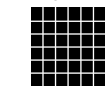
30x30 (5x5)
 MP187  **Mosaicos**
 Mosaics
 Mosaïques
 Mosaik

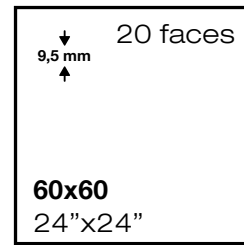
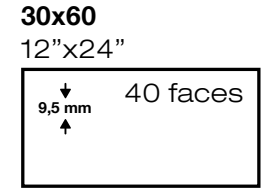
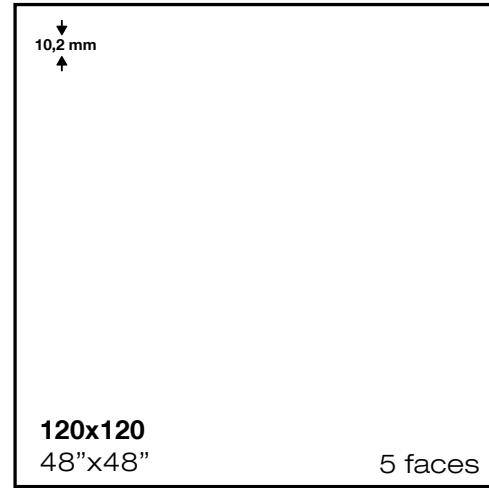

PACKING & SPECIAL PIECES

	Pc/Cj	M2/Cj	Cj/PI	M2/PI	Kg/Cj	Kg/PI
30x60	6	1,08	48	51,84	23,6	1152,8
60x60	4	1,44	30	43,2	31,4	962
60x120	2	1,44	32	46,08	34,25	1121
120x120	1	1,44	36	51,84	35	1300

	Rect. Mate
30x60	MP126
60x60	MP175
60x120	MP320
120x120	MP330

 **Ver página 428**
 See page 428



Valdivia crema 60x60 / 24"x24" _ Valdivia crema 30x60 / 12"x24" _ Mosaico Valdivia crema 30x30 / 12"x12"



zanzibar



Zanzibar almond 60x120 / 24"x48"

zanzibar

DCOF



pavimento _ porcelánico _ rectificado _ mate
 floor tile _ porcelain _ rectified _ matt



Serie susceptible de tratamiento antideslizante bajo demanda.
 Series susceptible to anti-slip treatment on request.
 Série sensible au traitement antidérapant sur demande.
 Serie mit Antirutschbehandlung auf Anfrage.

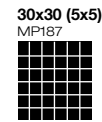

Mosaicos
 Mosaics
 Mosaïques
 Mosaik

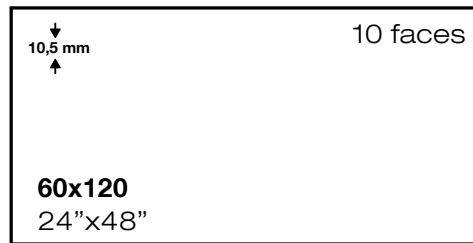

PACKING & SPECIAL PIECES

	Pc/Cj	M2/Cj	Cj/PI	M2/PI	Kg/Cj	Kg/PI
60x120	2	1,44	32	46,08	34,25	1121

Rect. Mate
60x120 MP320

Ver página 428
 See page 428

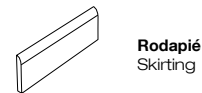

Rodapié
 Skirting

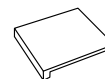

Peldaño
 Step

Zanzibar blue 60x120 / 24"x48" _ Antibes grey 120x120 / 48"x48"



almond

blue



oxyde



Oxyde turquoise 60x120 / 24"x48" _ Ziro crema 60x120 / 24"x48"



oxyde

DCOF



pavimento _ porcelánico _ rectificado _ masa coloreada _ mate
 floor tile _ porcelain _ rectified _ colored body _ matt



Serie susceptible de tratamiento antideslizante bajo demanda.
 Series susceptible to anti-slip treatment on request.
 Série sensible au traitement antidérapant sur demande.
 Serie mit Antirutschbehandlung auf Anfrage.

32,5x22,5
 13"x9" P861



Mosaicos
 Mosaics
 Mosaïques
 Mosaik

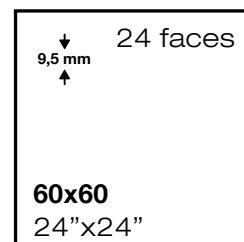
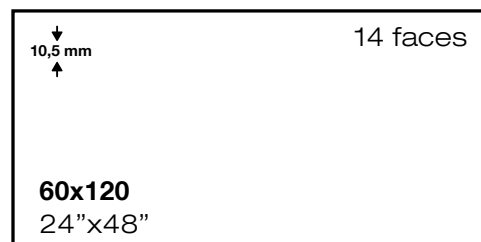
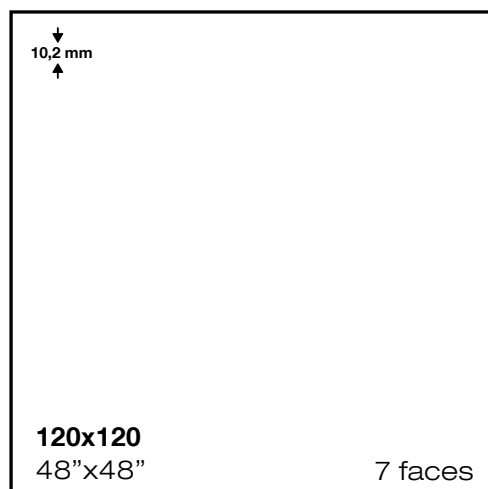

PACKING & SPECIAL PIECES

	Pc/Cj	M2/Cj	Cj/PI	M2/PI	Kg/Cj	Kg/PI
60x60	4	1,44	30	43,2	31,4	962
60x120	2	1,44	32	46,08	34,25	1121
120x120	1	1,44	36	51,84	35	1300

	Rect. Mate
60x60	MP175
60x120	MP320
120x120	MP330

Ver página 428
 See page 428



Rodapié
 Skirting

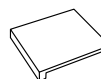

Peldaño
 Step

Oxyde blanc 60x120 / 24"x48" _ Mosaic oxyde blanc 32,5x22,5 / 13"x9"



blanc

turquoise

bleu

grise

noir

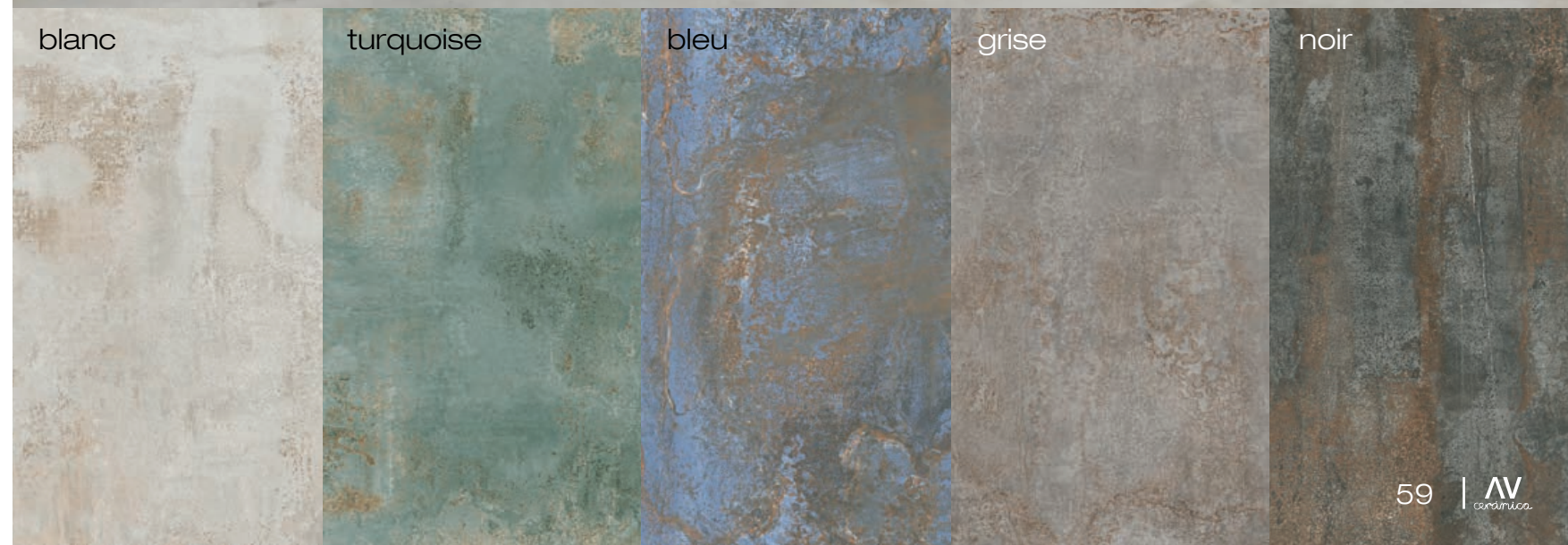

gerhy



Gerhy aluminio 60x60 / 24"x24

gerhy

DCOF



pavimento _ porcelánico _ rectificado _ masa coloreada _ mate
 floor tile _ porcelain _ rectified _ colored body _ matt



Serie susceptible de tratamiento antideslizante bajo demanda.
 Series susceptible to anti-slip treatment on request.
 Série sensible au traitement antidérapant sur demande.
 Serie mit Antirutschbehandlung auf Anfrage.

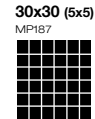

Mosaicos
 Mosaics
 Mosaïques
 Mosaik

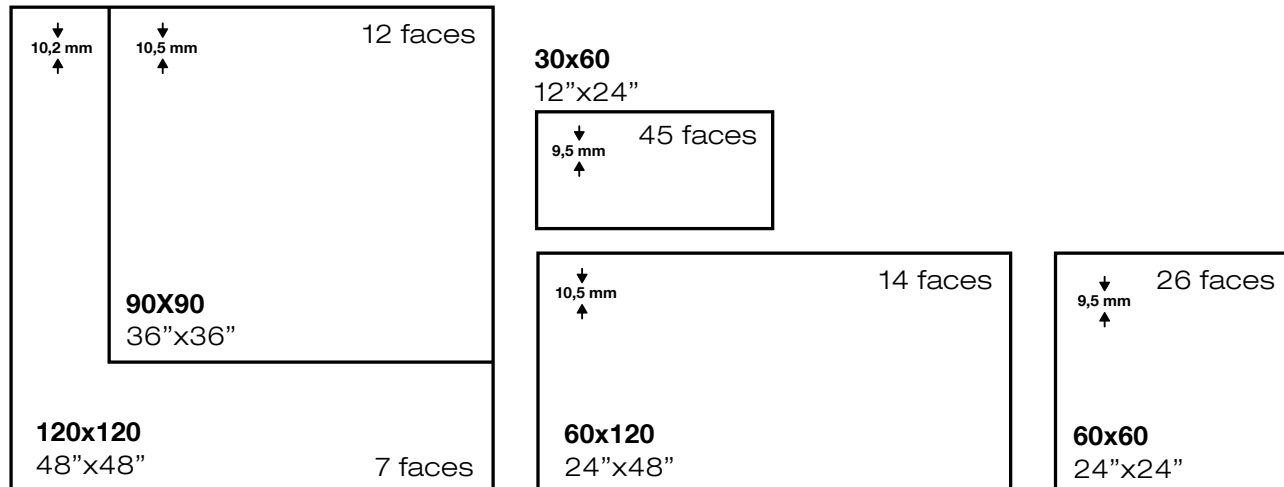

PACKING & SPECIAL PIECES

	Pc/Cj	M2/Cj	Cj/PI	M2/PI	Kg/Cj	Kg/PI
30x60	6	1,08	48	51,84	23,6	1152,8
60x60	4	1,44	30	43,2	31,4	962
60x120	2	1,44	32	46,08	34,25	1121
90x90	2	1,62	27	43,74	40	1110
120x120	1	1,44	36	51,84	35	1300

	Mate
30x60	MP126
60x60	MP175
60x120	MP320
90x90	MP207
120x120	MP330

Ver página 428
 See page 428

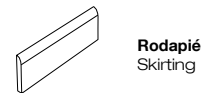

Rodapié
 Skirting

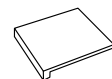

Peldaño
 Step

Gerhy plomo 120x120 / 48"x48"



aluminio

plata

acero

plomo

method

Method white mate 75x150 / 30"x60" _ Method antracita mate 75x150 / 30"x60" _ Mauka roble 23x120 / 10"x48"

antibacteriano

antibacterial / antibactérien / antibakteriell

La gran mayoría de bacterias son inocuas para la salud, no obstante, existen algunas dañinas que se pueden propagar en las superficies generando desde malos olores hasta posibles dolencias. Por esta razón, resulta imprescindible llevar a cabo procesos de limpieza exhaustivos, sobretodo en zonas comunes de uso corriente. En respuesta a esta necesidad, se ha desarrollado la serie Method, que, gracias al uso de iones de plata integrados en la masa cerámica, mejora la higiene en la superficie de la misma. En este sentido, también ofrece un valor añadido de protección para los usos más intensos.

Beneficios)

/ Impedimento del desarrollo de microorganismos, por lo que nos protege contra todo tipo de bacterias.

/ La eficiencia antimicrobiana se ha determinado según la norma JIS 2801 y el ensayo para la protección antivírica ISO 21702.

/ Zonas limpias durante más tiempo, y más fáciles de higienizar debido a sus propiedades antibacterianas.

/ Material recomendado para todo tipo de usos y zonas.

The vast majority of bacteria are harmless to health, however, there are some harmful ones that can spread on surfaces generating from bad odors to possible diseases. For this reason, it is essential to carry out exhaustive cleaning processes, especially in areas of common use. In response to this need, we have developed the Method collection, which, thanks to the use of silver ions integrated in the ceramic body, improves hygiene on the tile surface. In this sense, it also offers an extra protection for the most intense uses.

Benefits)

/ Impediment of the development of microorganisms, so it protects us against all types of bacteria.

/ The antimicrobial efficiency has been determined according to the JIS 2801 standard and the ISO 21702 antiviral protection test.

/ Clean areas for longer, and easier to sanitize due to its antibacterial properties.

/ Recommended material for all types of uses and areas.

La grande majorité des bactéries sont inoffensives pour la santé, cependant, certaines sont nocives qui peuvent se propager sur les surfaces, générant de mauvaises odeurs au possible maux. Pour cette raison, il est essentiel d'effectuer des processus de nettoyage exhaustifs, en particulier dans les zones communes d'usage courant. En réponse à ce besoin, a développé la série Method qui, grâce à l'utilisation d'ions argent intégrés dans la masse céramique, améliore l'hygiène de la surface céramique. En ce sens, aussi offre une valeur de protection supplémentaire pour les utilisations les plus intenses.

Avantages)

/ Empêchement du développement des microorganismes, il nous protège donc contre tous les types de bactéries.

/ L'efficacité antimicrobienne a été déterminée selon la norme JIS 2801 et le test de protection antivirale ISO 21702.

/ Nettoyer les zones plus longtemps et plus facilement désinfecter grâce à ses propriétés antibactériennes.

/ Matériel recommandé pour tous types d'utilisations et zones.

Die überwiegende Mehrheit der Bakterien ist gesundheitlich unbedenklich, jedoch gibt es einige schädliche Bakterien, die sich auf Oberflächen ausbreiten können und von schlechten Gerüchen bis hin zu möglichen Krankheiten führen. Aus diesem Grund ist eine gründliche Reinigung, insbesondere in den Gemeinschaftsbereichen des täglichen Gebrauchs, unerlässlich. Als Antwort auf dieses Bedürfnis wurde die Method-Serie entwickelt, die durch den Einsatz von Silberionen, die in die Keramikmasse integriert sind, die Hygiene der Keramikoberfläche verbessert. In dieser Hinsicht ist es auch Mehrwert in Bezug auf den Schutz für die intensivste Nutzung.

Leistungen)

/ Beeinträchtigung der Entwicklung von Mikroorganismen, dadurch Schutz vor allen Arten von Bakterien.

/ Die antimikrobielle Wirksamkeit wurde gemäß der Norm JIS 2801 und dem Test für antiviralen Schutz nach ISO 21702 bestimmt.

/ Flächen bleiben länger sauber und lassen sich aufgrund der antibakteriellen Eigenschaften leichter desinfizieren.

/ Material empfohlen für alle Arten von Anwendungen und Bereichen.

method

DCOF



pavimento _ porcelánico _ rectificado _ masa coloreada _ mate _ lappato
 floor tile _ porcelain _ rectified _ colored body _ matt _ lappato

 **Serie susceptible de tratamiento antideslizante bajo demanda.**
 Series susceptible to anti-slip treatment on request.
 Série sensible au traitement antidérapant sur demande.
 Serie mit Antirutschbehandlung auf Anfrage.

30x30 (5x5)
 LP MP188  **Mosaicos**
 Mosaics
 Mosaïques
 Mosaik

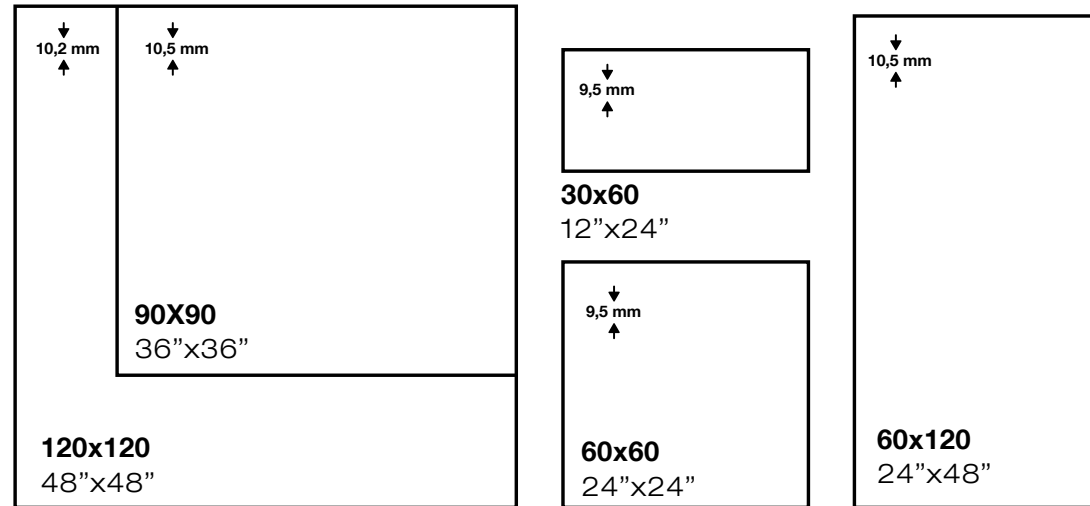

Peldaño Method bone 30x120 / 12"x48"

PACKING & SPECIAL PIECES

	Pc/Cj	M2/Cj	Cj/PI	M2/PI	Kg/Cj	Kg/PI
30x60	6	1,08	48	51,84	23,6	1152,8
60x60	4	1,44	30	43,2	31,4	962
60x120	2	1,44	32	46,08	34,25	1121
90x90	2	1,62	27	43,74	40	1110
120x120	1	1,44	36	51,84	35	1300

	Mate	Lappato
30x60	MP126	MP123
60x60	MP175	MP172
60x120	MP320	MP321
90x90	MP207	MP203
120x120	MP330	MP331

 **Ver página 428**
 See page 428

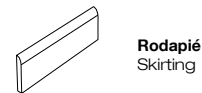

Rodapié
 Skirting

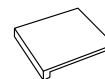

Peldaño
 Step

white

bone

mud

silver

antracita

ES

Material de dos cm de grosor, creado expresamente para exteriores y con la ventaja de tener que ir cementado al suelo, ya que por su propio peso, permanece quieto. Realizado en Adz.

EN

Two cm thick material, expressly created for exteriors and with the advantage of have to go cemented to the ground, since by its own weight, it remains still. Done in Adz.

FR

Matériau de deux cm d'épaisseur, créé expressément pour l'extérieur et avec l'avantage de devoir cimenté au sol, puisque par son propre poids, reste immobile. Fabriqué en Adz.

DE

Zwei cm dickes Material, speziell für den Außenbereich entwickelt und mit dem Vorteil, dass man gehen muss mit dem Boden zementiert, da es durch sein Eigengewicht bleib still. Hergestellt in Adz.

20
MM THICKNESS

PIAZZA • STREET • ZIRO

ziro

PO
 R
 CMYK
 V2
 GRUPO BIA
 CLASE 3
 THICKNESS 20mm

pavimento _ porcelánico _ rectificado _ mate
 floor tile _ porcelain _ rectified _ matt

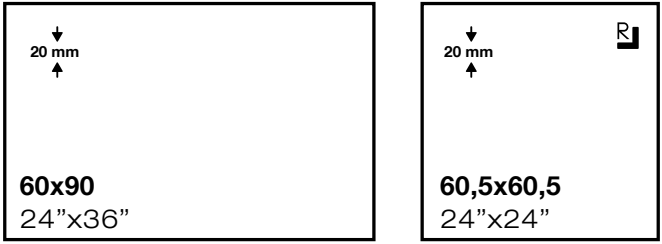

Ziro crema 60x90 / 24"x36"



PACKING & SPECIAL PIECES

	Pc/Cj	M2/Cj	Cj/PI	M2/PI	Kg/Cj	Kg/PI	
60,5x60,5	2	0,73	30	21,9	28,8	884	Rect. MP555
60x90	1	0,54	40	21,6	21,35	884	60x90 MP560

Ver página 428
See page 428



crema

perla



piazza



pavimento _ porcelánico _ rectificado _ mate
 floor tile _ porcelain _ rectified _ matt

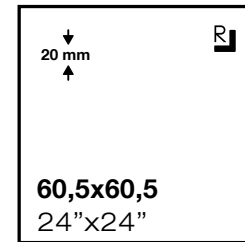
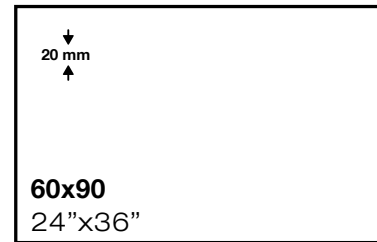

PACKING & SPECIAL PIECES

	Pc/Cj	M2/Cj	Cj/PI	M2/PI	Kg/Cj	Kg/PI	
60,5x60,5	2	0,73	30	21,9	28,8	884	Rect.
60x90	1	0,54	40	21,6	21,35	884	60,5x60,5 MP555
							60x90 MP560

Ver página 428
See page 428

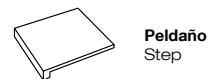
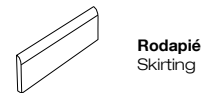

Piazza gris 60x90 / 24"x36"

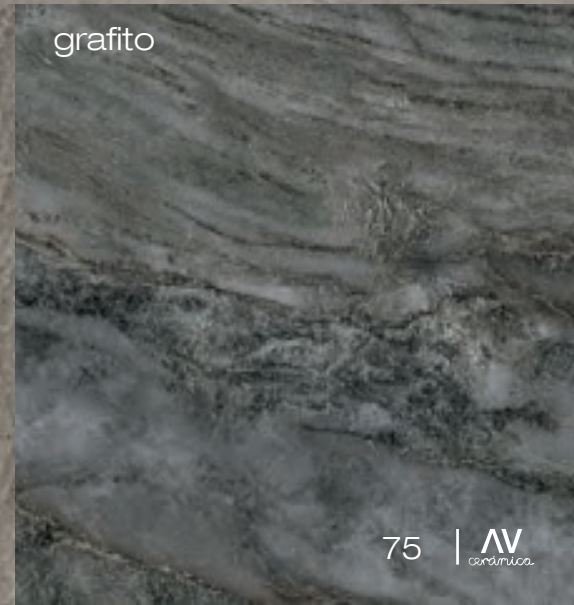
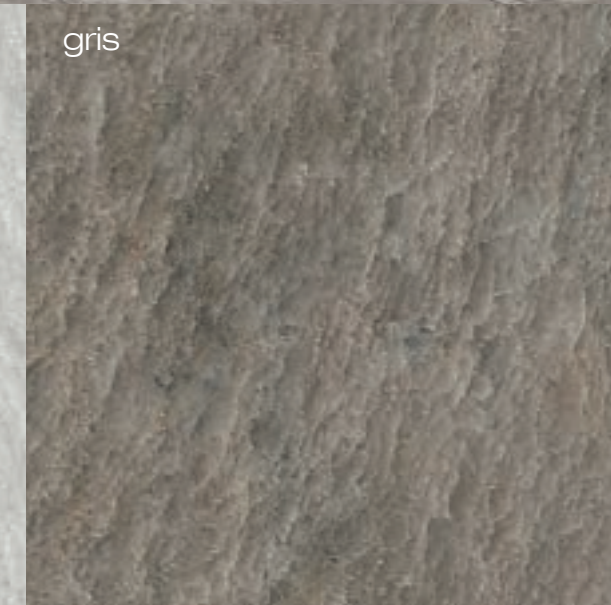
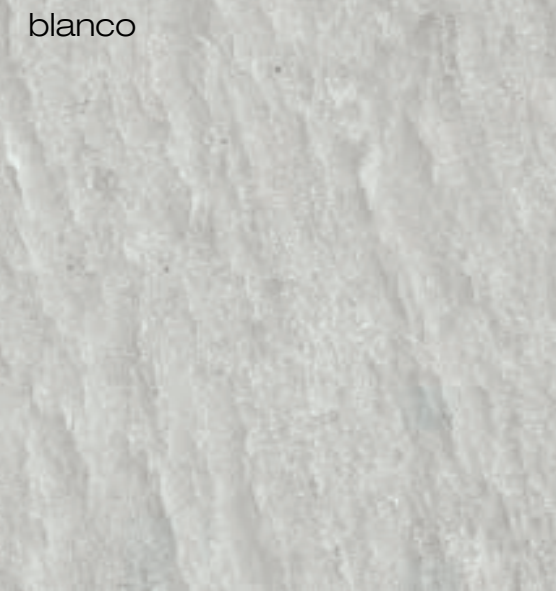

street



pavimento _ porcelánico _ rectificado _ mate
 floor tile _ porcelain _ rectified _ matt

Street beige 60,5x60,5 / 24"x24"

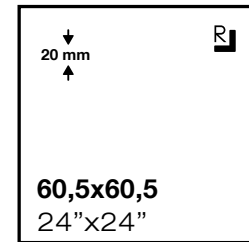
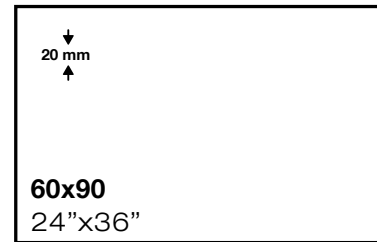

PACKING & SPECIAL PIECES

	Pc/Cj	M2/Cj	Cj/PI	M2/PI	Kg/Cj	Kg/PI		Rect.
60,5x60,5	2	0,73	30	21,9	28,8	884		60,5x60,5 MP555
60x90	1	0,54	40	21,6	21,35	884		60x90 MP560

 **Ver página 428**
See page 428

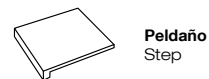
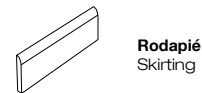

beige

silver



ES

La granilla pulida tiene la ventaja de que se esmalta, se pinta y luego se aplica una granilla brillo que será pulida, obteniendo unos colores muchos más vivos que con el esmalte pulido. La granilla son dos aplicaciones distintas.

EN

The polished grit has the advantage that it is enamelled, painted and then a gloss grit is applied that will be polished, obtaining much more vivid colors than with polished enamel. The granilla are two different applications.

FR

Le grain poli a l'avantage qu'il est émaillé, peint et puis un grain brillant est appliqué qui sera poli, obtenant des couleurs beaucoup plus vives qu'avec l'émail poli. La le grain est deux applications différent.

DE

Polierte Körnung hat den Vorteil dass es emailliert, bemalt und Anschließend wird eine glänzende Körnung aufgetragen das wird poliert, erhalten viel lebendigere Farben als mit poliertem Email. Der Splitt sind zwei Anwendungen anders.

HIP

HIGHLY POLISHED

DUOMO • MOLUKA • STROM

moluka

Moluka negro 120x120 / 48"x48"

moluka



pavimento _ porcelánico _ granilla pulida _ rectificado
 floor tile _ porcelain _ highly polished _ rectified

Moluka verde 120x120 / 48"x48"

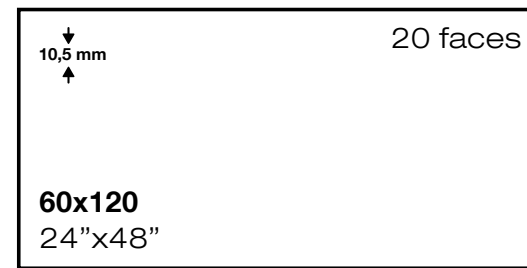
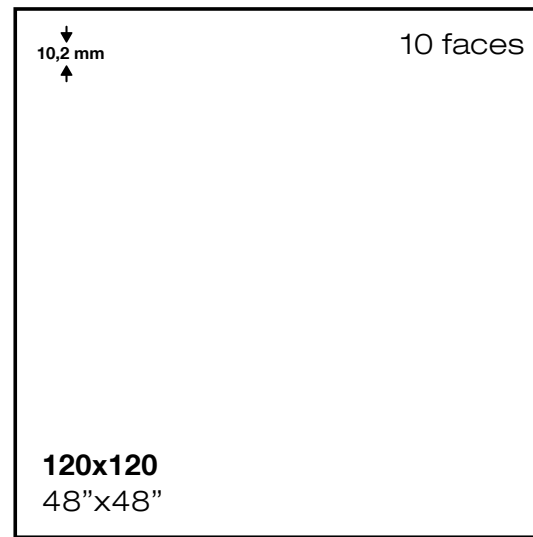

PACKING & SPECIAL PIECES

	Pc/Cj	M2/Cj	Cj/PI	M2/PI	Kg/Cj	Kg/PI
60x120	2	1,44	32	46,08	34,25	1121
120x120	1	1,44	36	51,84	35	1300

	Cód.
60x120	MP324
120x120	MP334

Ver página 427
See page 427

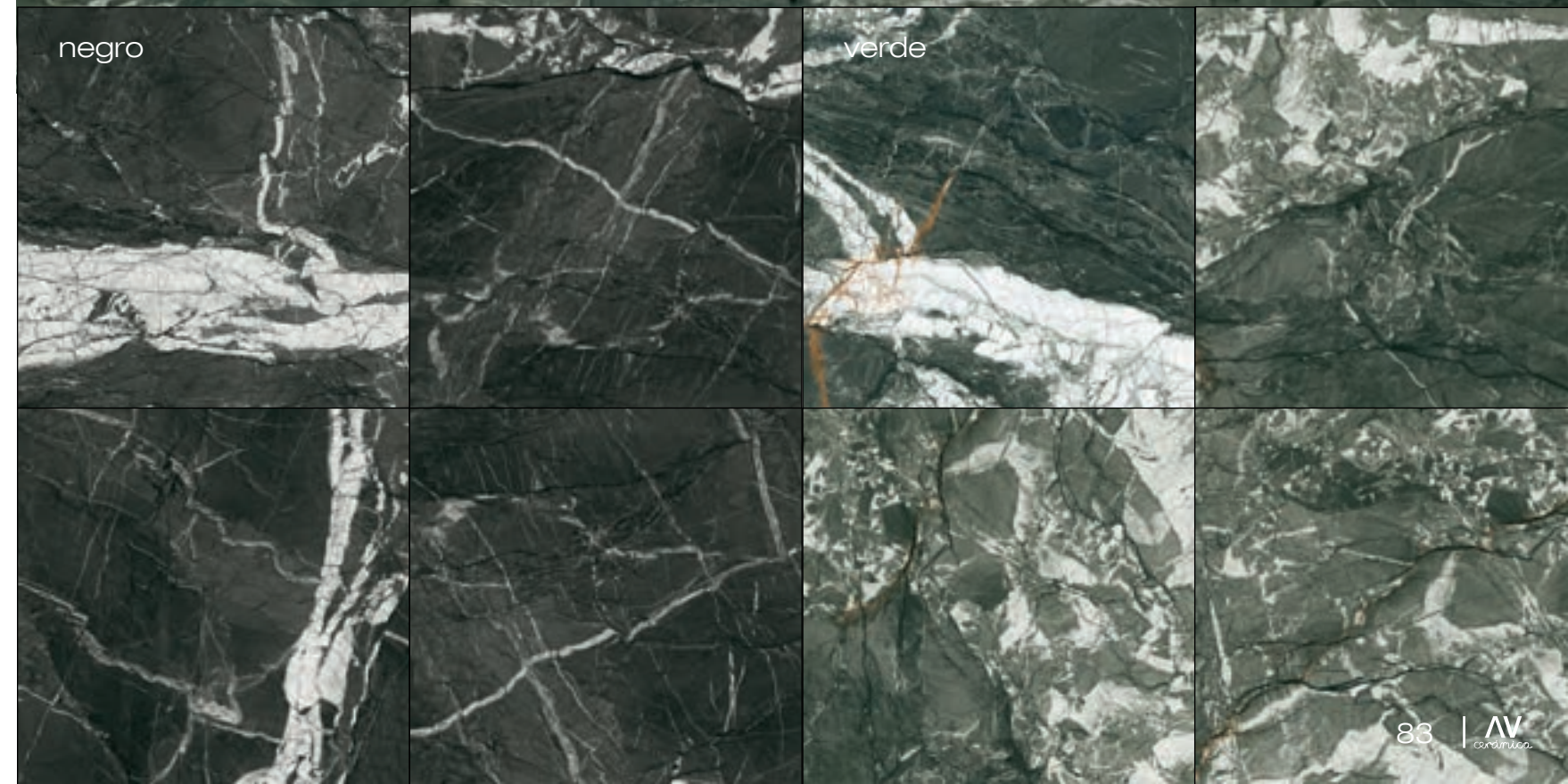
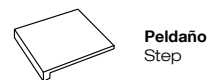

duomo

Duomo 120x120 / 48"x48"

duomo



pavimento _ porcelánico _ granilla pulida _ rectificado
 floor tile _ porcelain _ highly polished _ rectified

Duomo 120x120 / 48"x48"

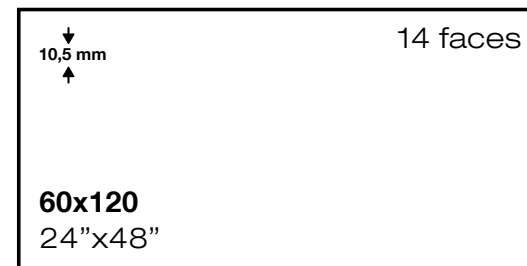
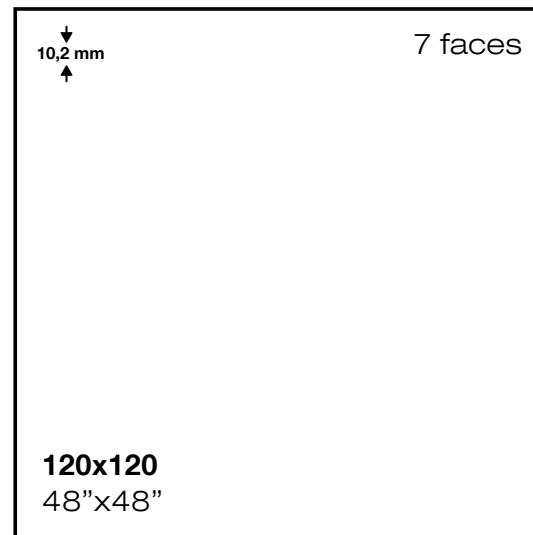

PACKING & SPECIAL PIECES

	Pc/Cj	M2/Cj	Cj/PI	M2/PI	Kg/Cj	Kg/PI
60x120	2	1,44	32	46,08	34,25	1121
120x120	1	1,44	36	51,84	35	1300

	Cód.
60x120	MP324
120x120	MP334

Ver página 427
 See page 427

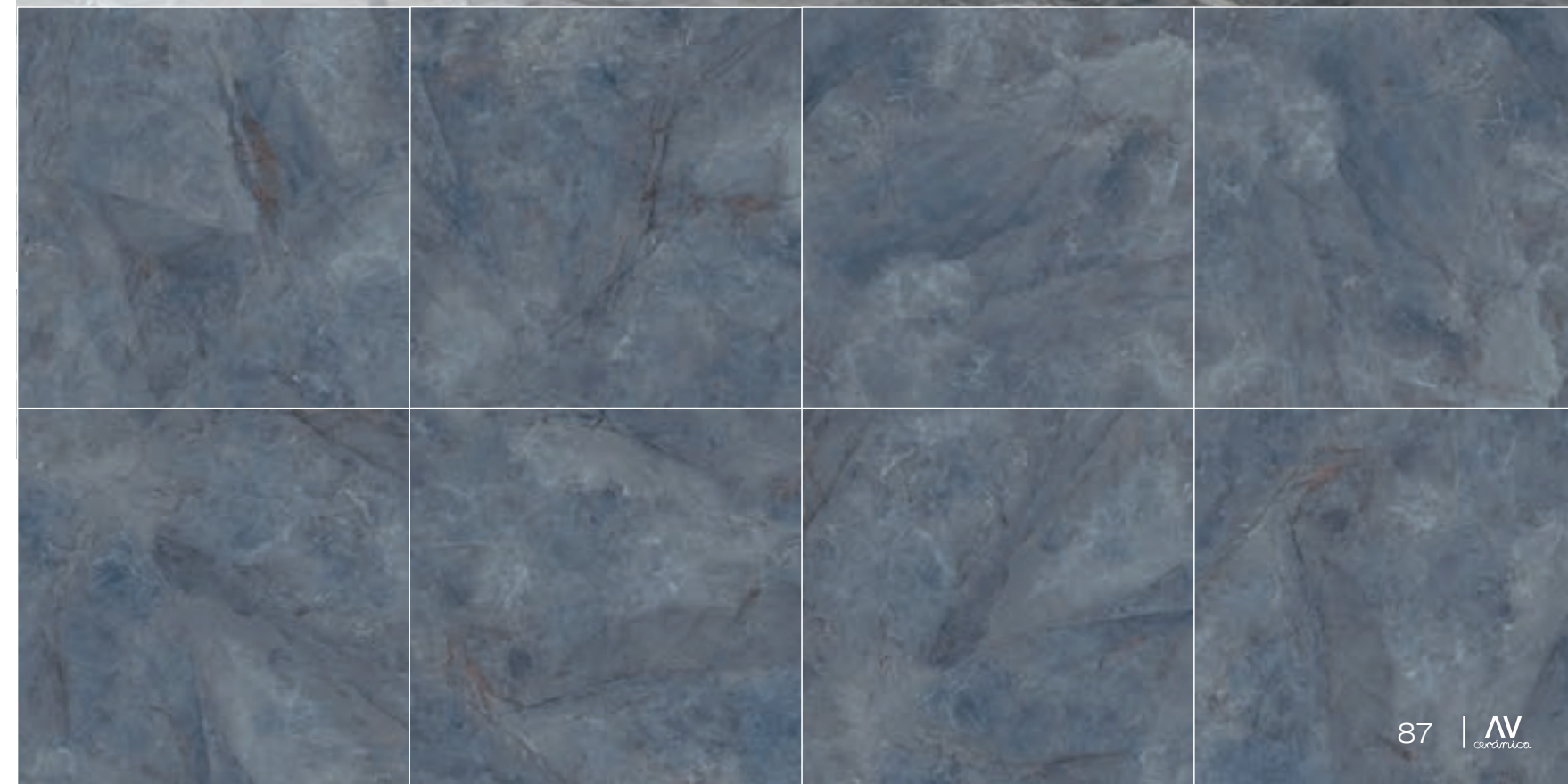
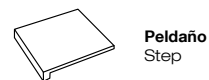

strom



Strom 120x120 / 48"x48"

strom



pavimento _ porcelánico _ granilla pulida _ rectificado
 floor tile _ porcelain _ highly polished _ rectified

Strom 120x120 / 48"x48"

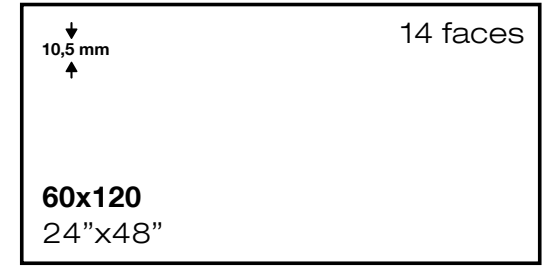
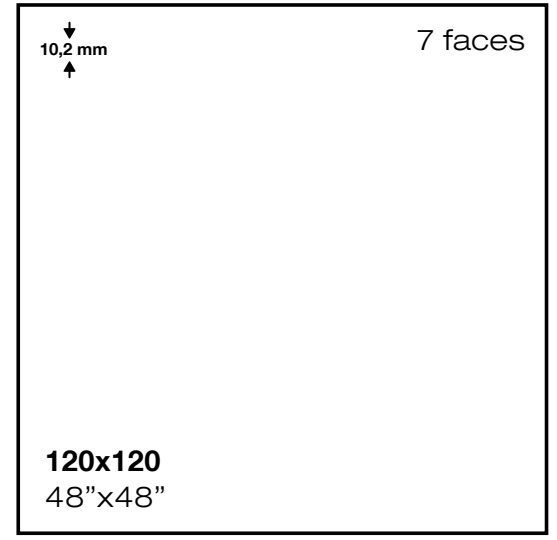

PACKING & SPECIAL PIECES

	Pc/Cj	M2/Cj	Cj/Pl	M2/Pl	Kg/Cj	Kg/Pl	Cód.
60x120	2	1,44	32	46,08	34,25	1121	60x120 MP324
120x120	1	1,44	36	51,84	35	1300	120x120 MP334

Ver página 427
See page 427

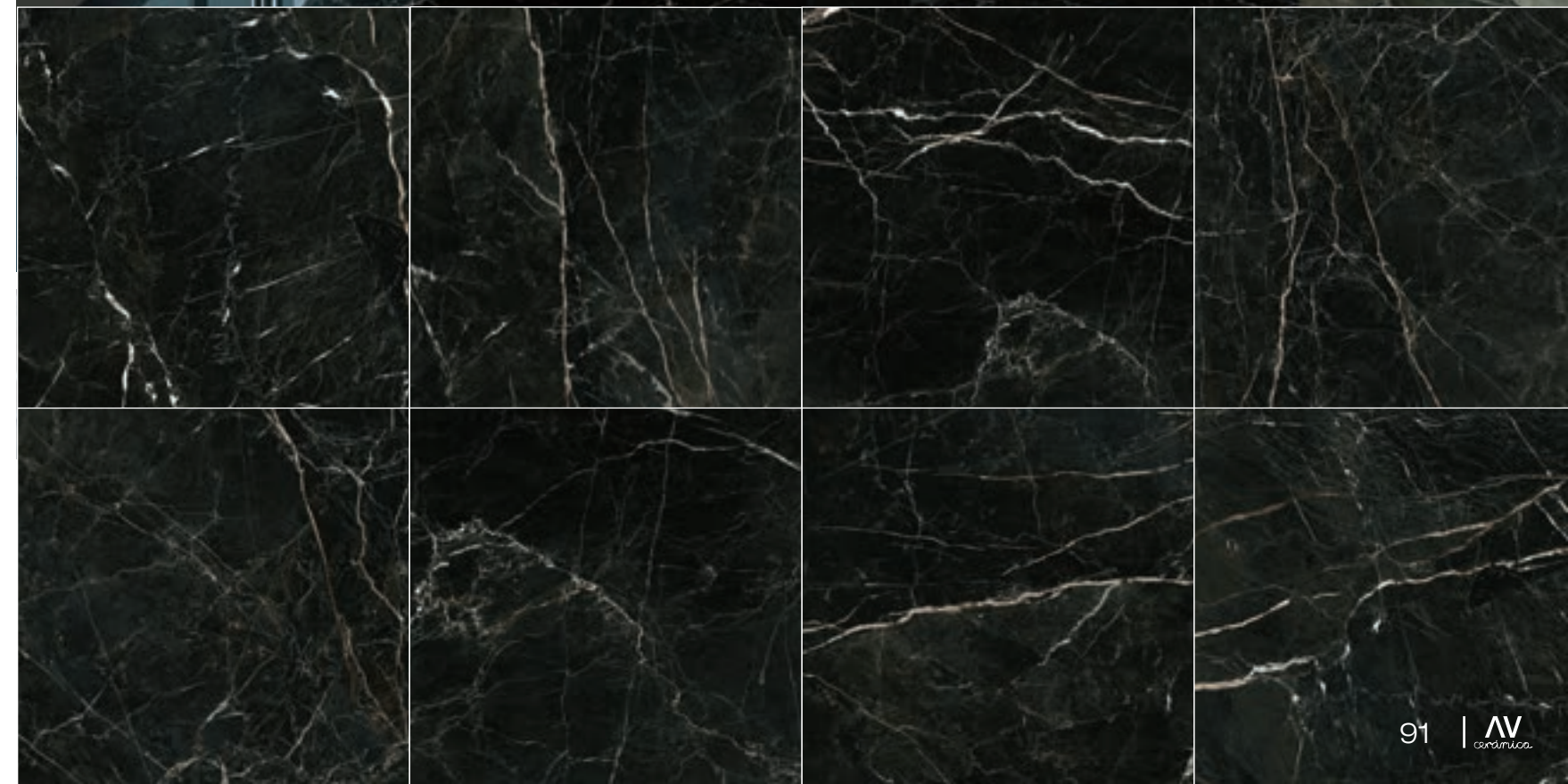

ES

Es la tinta brillo aplicada sobre un esmalte mate, dependiendo de la dureza del esmalte el brillo será mayor o menor.

EN

It's the ink glitter applied on a matt enamel, depending of the hardness of the enamel brightness will be higher or lower.

FR

C'est l'encre pailletée appliquée sur un émail mat, selon la dureté de l'émail, la brillance sera plus ou moins grande.

DE

Es sich lediglich um die aufgetragene Glitzertinte je nach Härte ein mattes Email des Zahnschmelzes wird der Glanz mehr oder weniger stark sein.

GI
GLOSSY INK

• BARROW •

barrow



Barrow white 120x120 / 48"x48"

barrow



pavimento _ porcelánico _ tinta brillo _ rectificado _ mate
 floor tile _ porcelain _ glossy ink _ rectified _ matt

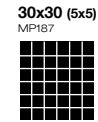

Mosaicos
 Mosaics
 Mosaiques
 Mosaik

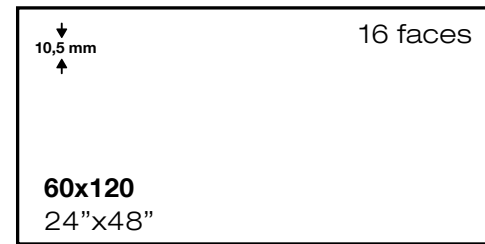
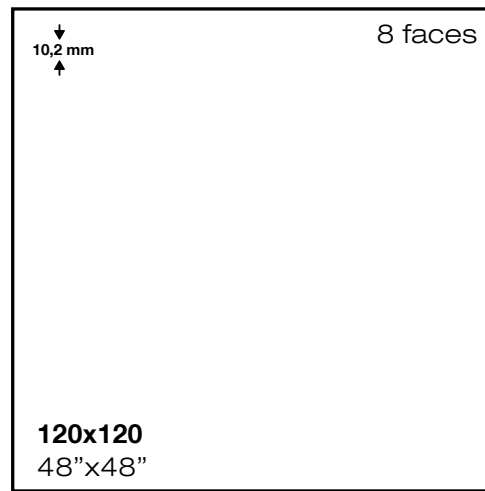

PACKING & SPECIAL PIECES

	Pc/Cj	M2/Cj	Cj/PI	M2/PI	Kg/Cj	Kg/PI
60x120	2	1,44	32	46,08	34,25	1121
120x120	1	1,44	36	51,84	35	1300

	Rect. Mate
60x120	MP320
120x120	MP330

Ver página 427
 See page 427

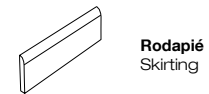

Rodapié
 Skirting

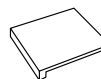

Peldaño
 Step

Barrow white 120x120 / 48"x48"



ES

Esta técnica consiste en hacer un doble pulido, primero la pieza se queda brillo y posteriormente al pasar por otro pulido se consigue el efecto satinado y desgastado de los mármoles o piedras antiguas.

EN

This technique consists of doing a double polishing, first the piece becomes shiny and then, when it goes through another polishing, the satin and worn effect of marble or antique stones is achieved.

FR

Cette technique consiste à effectuer un double polissage, d'abord la pièce devient brillante puis lorsqu'elle passe par un autre polissage, on obtient l'effet satiné et usé du marbre ou des pierres anciennes.

DE

Bei dieser Technik wird eine doppelte Politur durchgeführt, bei der das Stück zunächst glänzt und dann, wenn es einer weiteren Politur unterzogen wird, der satinierte und abgenutzte Effekt von Marmor oder antiken Steinen erzielt wird.

P
POLIMAT

• SLASH •

slash

Slash black 60x120 / 24"x48" _ Malla Slash black 30x30 / 12"x12"

slash



pavimento _ porcelánico _ polimat _ rectificado
 floor tile _ porcelain _ polimat _ rectified

30x30 (3x15)
 P854
Mosaicos
 Mosaics
 Mosaïques
 Mosaik

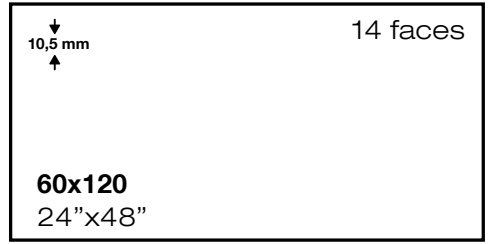
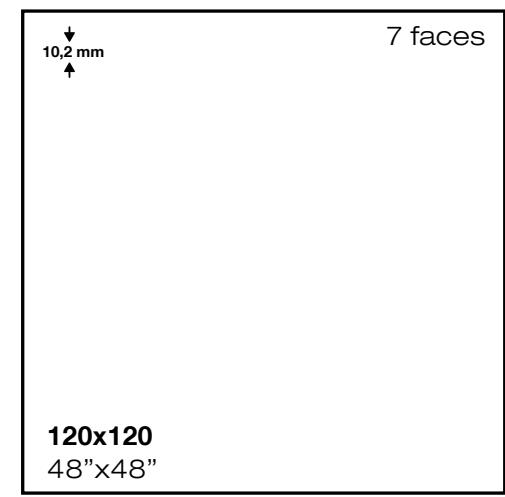

PACKING & SPECIAL PIECES

	Pc/Cj	M2/Cj	Cj/PI	M2/PI	Kg/Cj	Kg/PI		Rect. Mate
60x120	2	1,44	32	46,08	34,25	1121	60x120	MP322
120x120	1	1,44	36	51,84	35	1300	120x120	MP332

Ver página 427
 See page 427



Slash grey 120x120 / 48"x48"

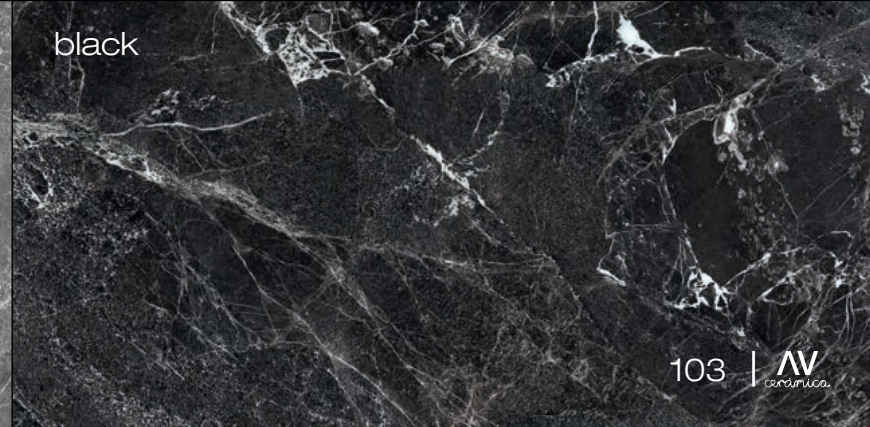
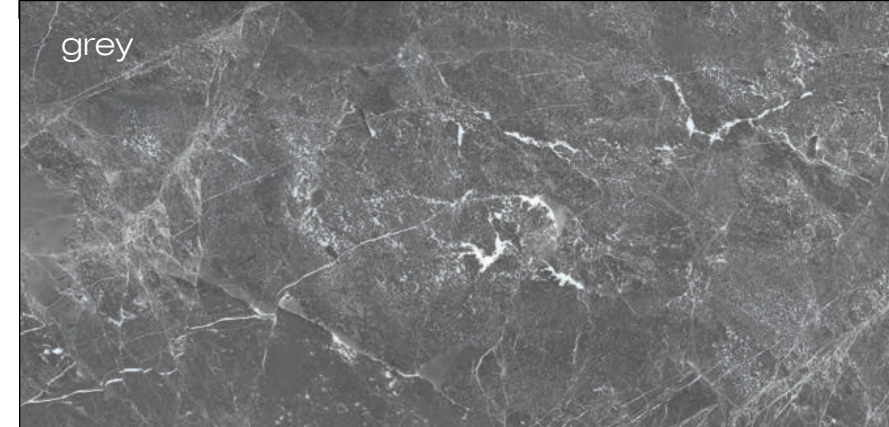

ES

Misma metodología que la granilla pulida, pero con diferentes granillas, primero se esmalta, luego se pinta y finalmente se aplica la granilla, pasando una vez cocidas a pulir.

EN

Same methodology as highly polished, but with different granules, first glazed, then it is painted and once the tile is fired, then we polished it.

FR

Même méthodologie que le grain poli, mais avec un grains, d'abord il est glacé, puis il est peint et enfin appliquer le grain en passant un une fois cuit pour polir.

DE

o Dieselbe Technik wie bei der polierten Körnung, aber mit unterschiedlichen Körnungen, zuerst glasiert, dann bemalt und schließlich wird die Körnung aufgetragen, nach dem Brennen wird sie poliert.

L
LAPPATO

CAELUM • CHRISTY • GIVET

givet



Givet grey 120x120 / 48"x48" _ Ziro gris 120x120 / 24"x48"

givet



pavimento _ porcelánico _ metallic lappato _ rectificado
 floor tile _ porcelain _ metallic lappato _ rectified

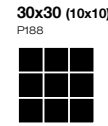

Mosaicos
 Mosaics
 Mosaïques
 Mosaik

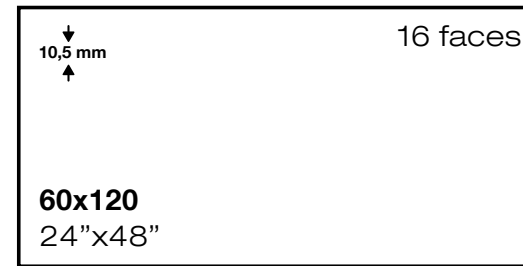
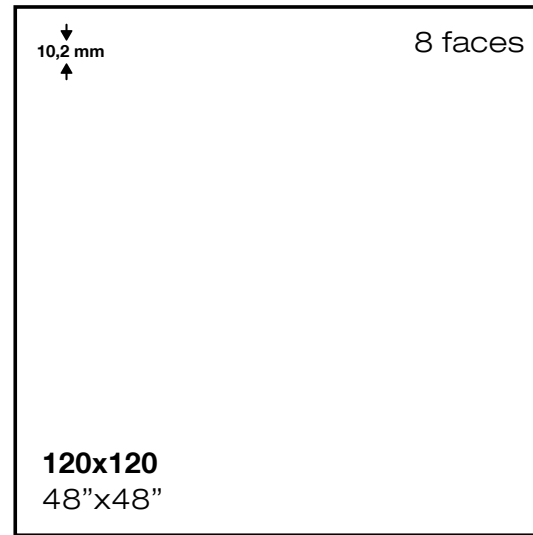

PACKING & SPECIAL PIECES

	Pc/Cj	M2/Cj	Cj/PI	M2/PI	Kg/Cj	Kg/PI
60x120	2	1,44	32	46,08	34,25	1121
120x120	1	1,44	36	51,84	35	1300

	Cód.
60x120	MP331
120x120	MP321

Ver página 427
 See page 427



Rodapié
 Skirting

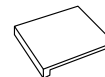

Peldaño
 Step

Givet pink 120x120 / 48"x48" _ Mosaic Givet pink 30x30 / 12"x12" _ Ziro crema 60x120 / 24"x48"

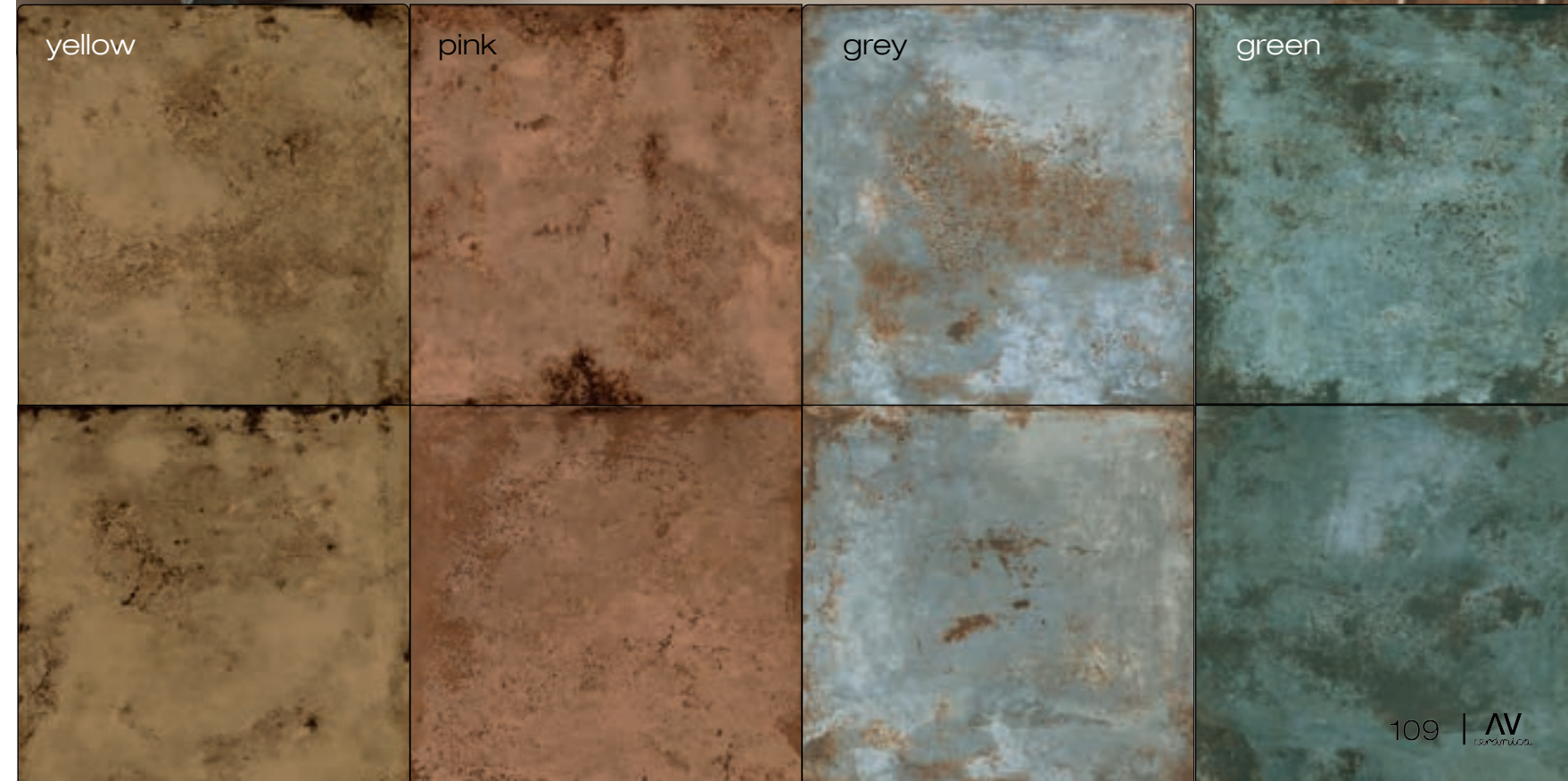
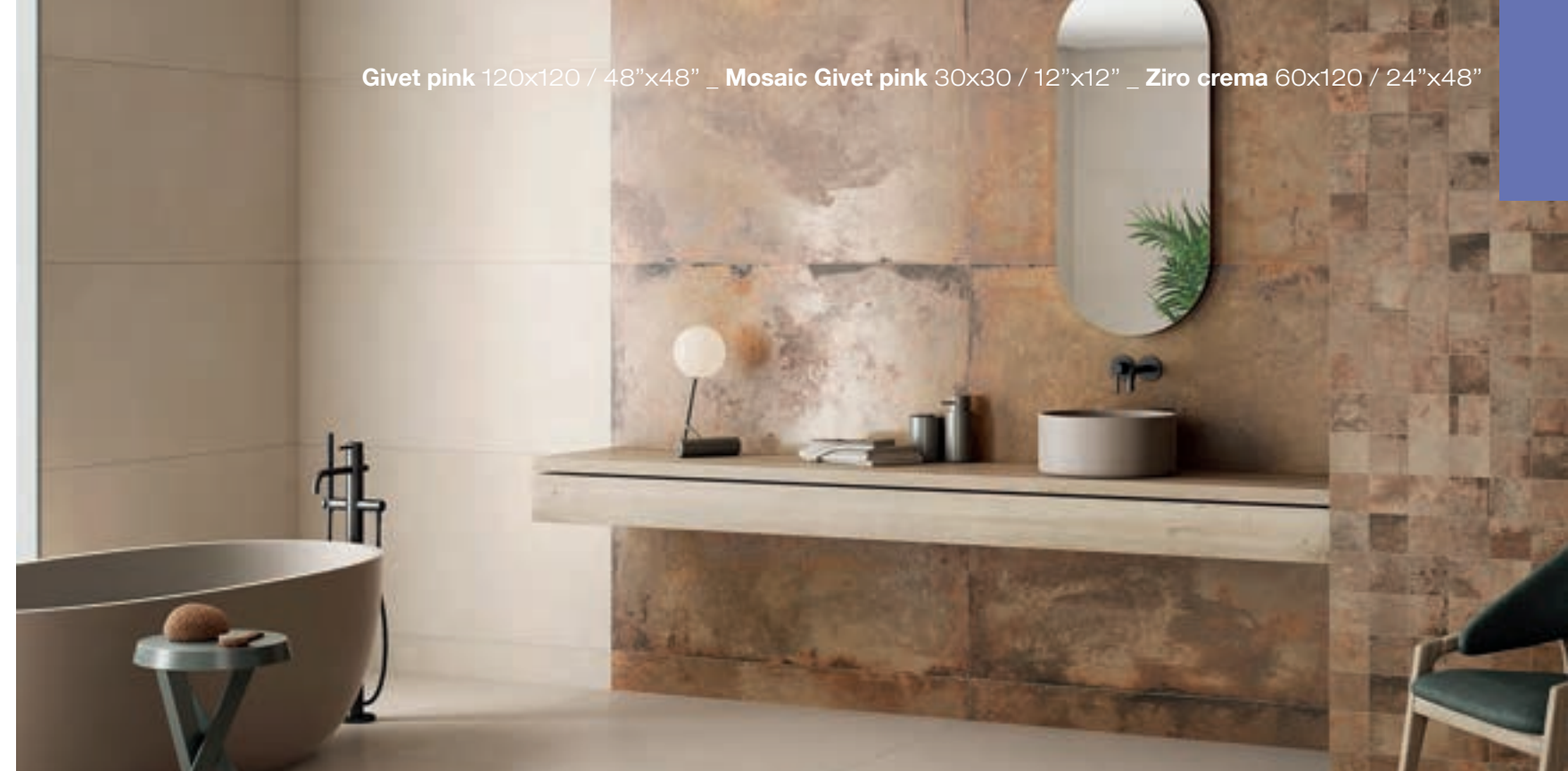

christy

Christy blanco 120x120 / 48"x48" _ Christy blanco 60x120 / 24"x48"

christy



pavimento _ porcelánico _ sugar lappato _ rectificado
 floor tile _ porcelain _ sugar lappato _ rectified

Christy marfil 120x120 / 48"x48"

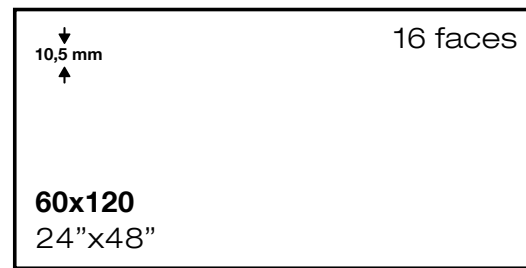
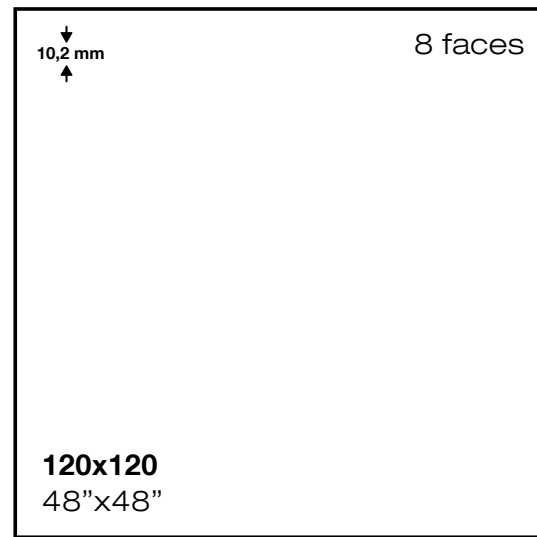

PACKING & SPECIAL PIECES

	Pc/Cj	M2/Cj	Cj/PI	M2/PI	Kg/Cj	Kg/PI
60x120	2	1,44	32	46,08	34,25	1121
120x120	1	1,44	36	51,84	35	1300

	Cód.
60x120	MP321
120x120	MP331

Ver página 427
See page 427

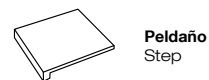
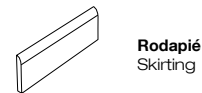

blanco

marfil

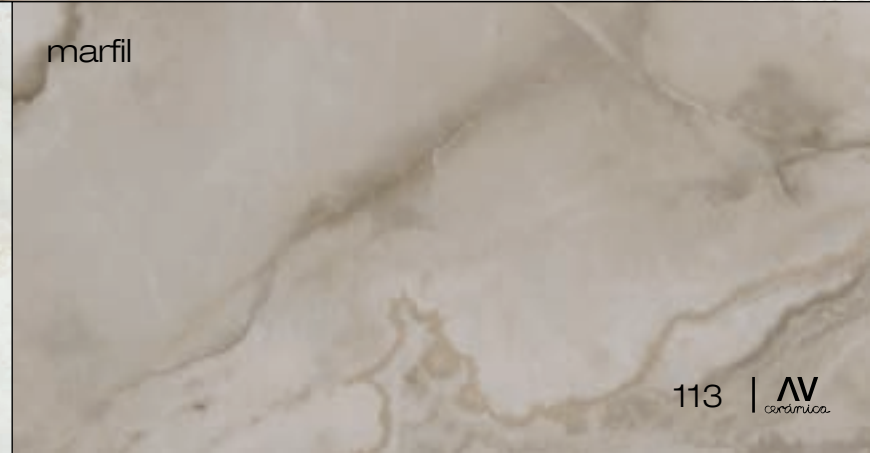

caelum



Caelum 60x120 / 24"x48" _ Savio neutral 60x120 / 24"x48"

caelum



pavimento _ porcelánico _ sugar lappato _ rectificado
 floor tile _ porcelain _ sugar lappato _ rectified

Caelum 120x120 / 48"x48"

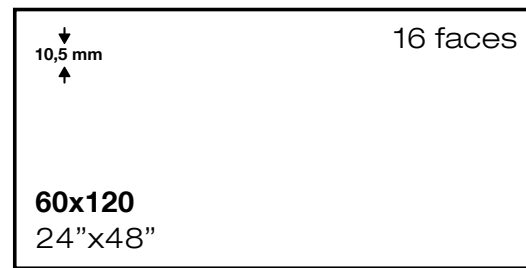
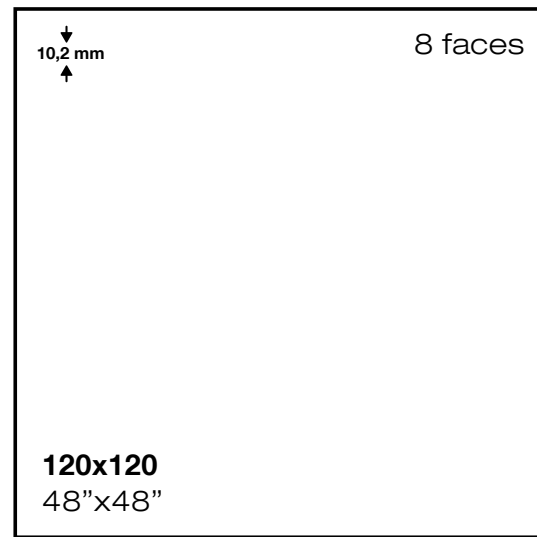

PACKING & SPECIAL PIECES

	Pc/Cj	M2/Cj	Cj/PI	M2/PI	Kg/Cj	Kg/PI
60x120	2	1,44	32	46,08	34,25	1121
120x120	1	1,44	36	51,84	35	1300

	Cód.
60x120	MP331
120x120	MP321

Ver página 427
See page 427



ES

Con el esmalte pulido se obtienen dos terminaciones en una sola aplicación, el mate satinado y el brillo en el caso de pulirse, Ventajas que la producción es la misma por lo que no existen variaciones del mate al pulido brillo.

EN

With polished enamel, two finishes are obtained in a single application, satin matte and gloss in the case of polishing. This comes with the advantage that there won't be variations between matt and polished as they come from the same process.

FR

Avec l'émail poli, deux finitions sont obtenues en une seule application, le satiné mat et le brillant dans le cas du polissage, avantages que la production est la même donc il n'y a pas de variations du brillant mat au brillant poli.

DE

Mit der polierten Emaille werden in einer einzigen Anwendung zwei Oberflächen erzielt: die seidenmatte und die Glanz beim Polieren. Der Vorteil besteht darin, dass die Produktion gleich ist und es daher keine Abweichungen von mattem zu poliertem Glanz gibt.

PPP

POLISHED PORCELAIN

AERIS • ALLURE • AURA • BASIL • BRUCE • BUTÁN • CLOTHY
ELDER • FORUM • GOLDEN • KENDALL • LANCE • LINDSAY • LUGANO
ORIX • PULSAR • RIOLA • SAVIO • TEKALI • TYRA • URLI BLUE • UYUNI
VITERBO • ZOXY

elder



Elder taupe 60x120 / 24"x48" _ Elder taupe 120x120 / 48"x48"

elder



pavimento _ porcelánico _ pulido _ rectificado
 floor tile _ porcelain _ polished _ rectified



Serie también disponible en mate.
 Series also available in matt.
 Série également disponible en mat.
 Serie auch in matt erhältlich.



* dc tinsel

Revestimiento / Decorado de la serie.
 Wall tile / Deco from the series.
 Enrobage / Décoré de la série.
 Wandfliesen / Dekoriert aus der Serie. **P805**

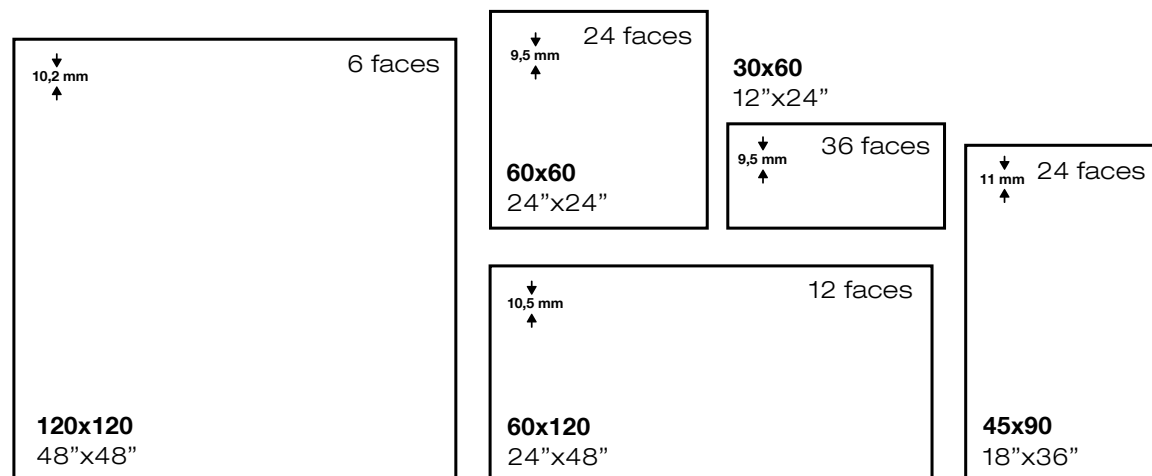

PACKING & SPECIAL PIECES

	Pc/Cj	M2/Cj	Cj/PI	M2/PI	Kg/Cj	Kg/PI
30x60	6	1,08	48	51,8	23,6	1152,8
45x90	3	1,21	44	53,24	28,7	1282,8
60x60	4	1,44	30	43,2	31,4	962
60x120	2	1,44	32	46,08	34,25	1121
120x120	1	1,44	36	51,84	35	1300

	Pulido	Mate
30x60	MP124	MP126
45x90	MP310	MP300
60x60	MP174	MP175
60x120	MP323	MP320
120x120	MP333	MP330

Ver página 427
 See page 427



Rodapié
 Skirting

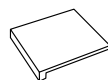

Peldaño
 Step

Elder gris 120x120 / 48"x48"



savio



Savio red matt 120x120 / 48"x48" _ Bonny anthracite matt 15x15 / 6"x6"

savio



pavimento _ porcelánico _ pulido _ rectificado
 floor tile _ porcelain _ polished _ rectified



Serie también disponible en mate.
 Series also available in matt.
 Série également disponible en mat.
 Serie auch in matt erhältlich.

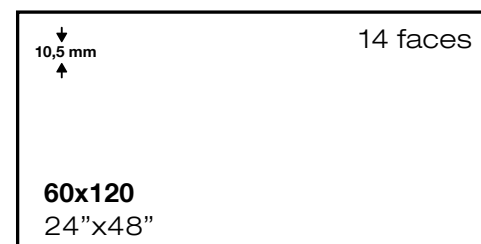
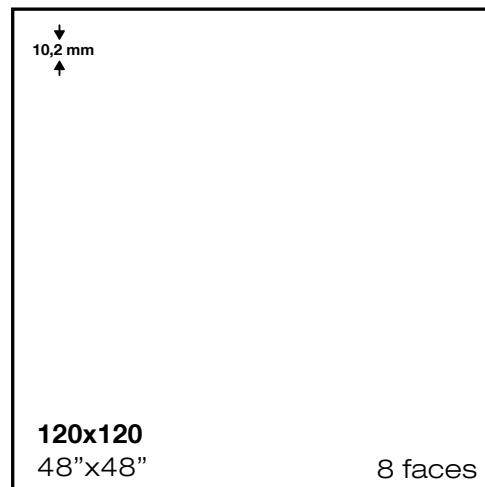

PACKING & SPECIAL PIECES

	Pc/Cj	M2/Cj	Cj/PI	M2/PI	Kg/Cj	Kg/PI
60x120	2	1,44	32	46,08	34,25	1121
120x120	1	1,44	36	51,84	35	1300

	Rect. Pul.	Rect. Matt
60x120	MP323	MP320
120x120	MP333	MP330

Ver página 427
See page 427

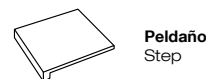

Savio neutral 120x120 / 48"x48" _ Ziro perla 120x120 / 48"x48"

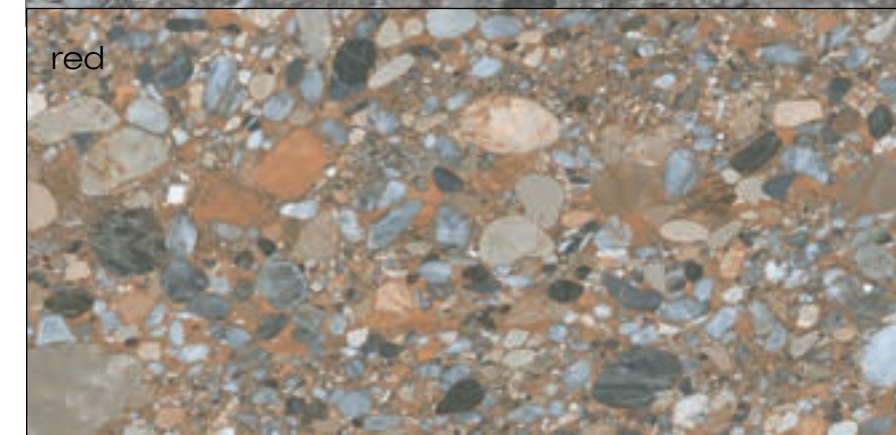



Orix

Orix marfil 90x90 / 36"x36"

orix



pavimento _ porcelánico _ pulido _ rectificado
 floor tile _ porcelain _ polished _ rectified

Orix perla 90x90 / 36"x36"

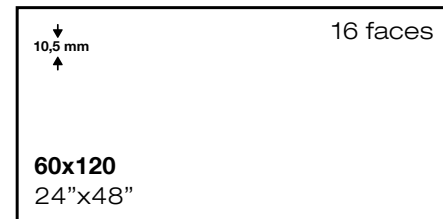
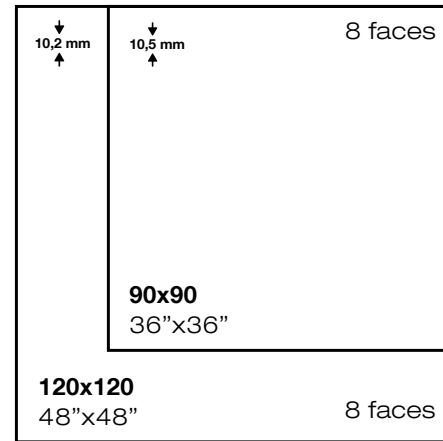

PACKING & SPECIAL PIECES

	Pc/Cj	M2/Cj	Cj/PI	M2/PI	Kg/Cj	Kg/PI
90x90	2	1,62	27	43,74	40	1110
60x120	2	1,44	32	46,08	34,25	1121
120x120	1	1,44	36	51,84	35	1300

	Pulido
90x90	MP204
60x120	MP323
120x120	MP333

Ver página 427
See page 427

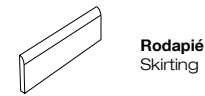

Rodapié
Skirting

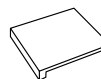

Peldaño
Step



basil



Basil white 120x120 / 48"x48"

basil



pavimento _ porcelánico _ pulido _ rectificado
 floor tile _ porcelain _ polished _ rectified



Serie también disponible en mate.

Series also available in matt.

Série également disponible en mat.

Serie auch in matt erhältlich.

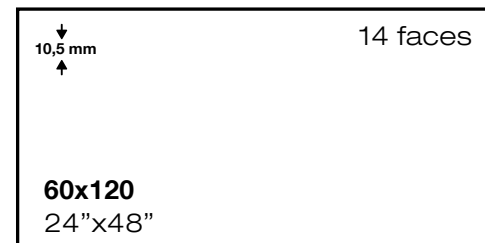
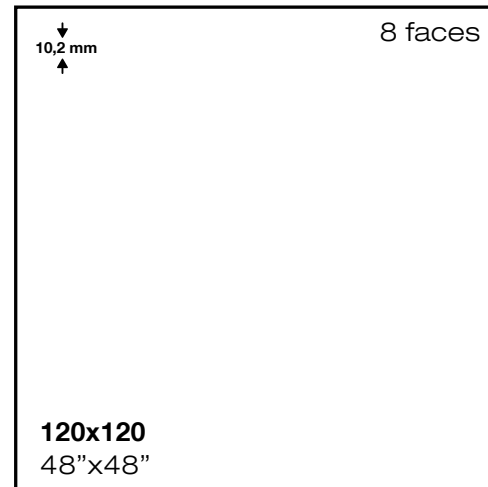

PACKING & SPECIAL PIECES

	Pc/Cj	M2/Cj	Cj/PI	M2/PI	Kg/Cj	Kg/PI
60x120	2	1,44	32	46,08	34,25	1121
120x120	1	1,44	36	51,84	35	1300

	Rect. Pul.	Rect. Matt
60x120	MP323	MP320
120x120	MP333	MP330

Ver página 427
 See page 427

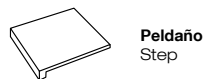
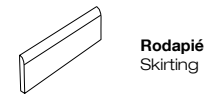

Basil bone 120x120 / 48"x48"



allure



Allure gris 90x90 / 36"x36"

allure



pavimento _ porcelánico _ pulido _ rectificado
 floor tile _ porcelain _ polished _ rectified

Allure crema 120x120 / 48"x48"

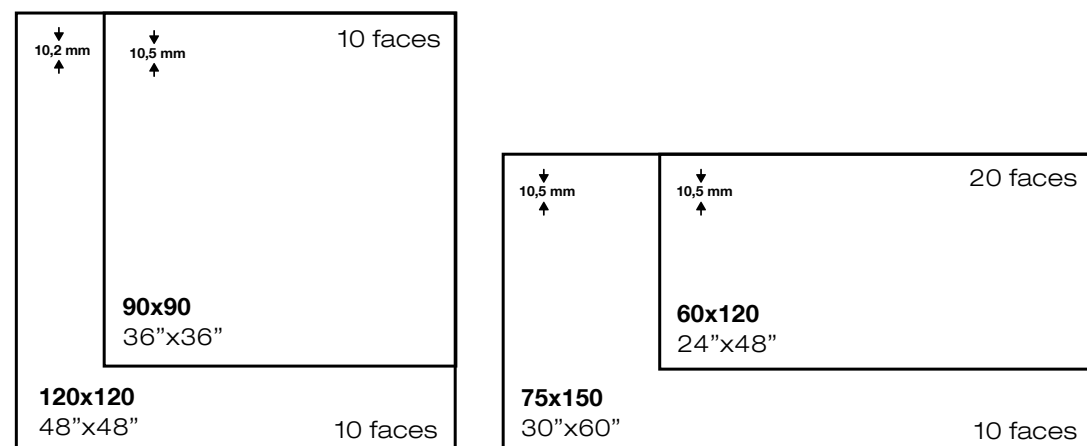

PACKING & SPECIAL PIECES

	Pc/Cj	M2/Cj	Cj/Pl	M2/Pl	Kg/Cj	Kg/Pl
60x120	2	1,44	32	46,08	34,25	1121
90x90	2	1,62	27	43,74	40	1110
120x120	1	1,44	36	51,84	35	1300
75x150	1	1,13	40	45,2	28	1184

	Pulido
60x120	MP323
90x90	MP204
120x120	MP333
75x150	MP343

Ver página 427
See page 427

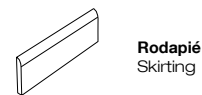

Rodapié
Skirting

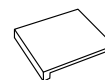

Peldaño
Step

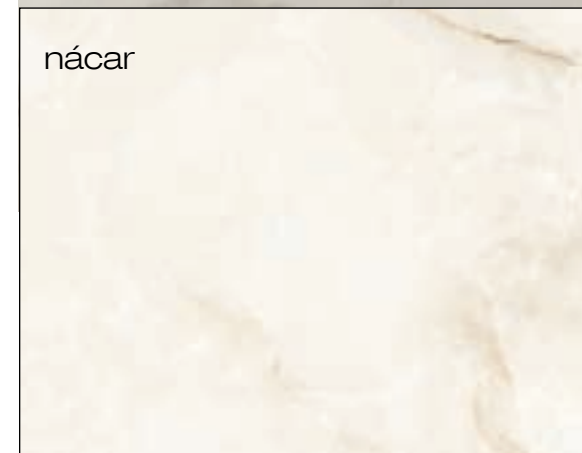

nácar

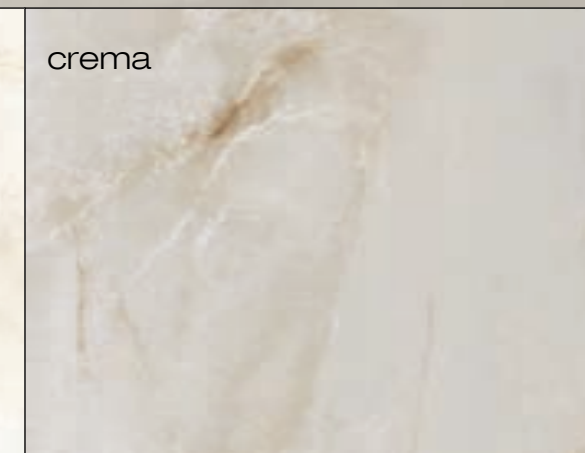

crema

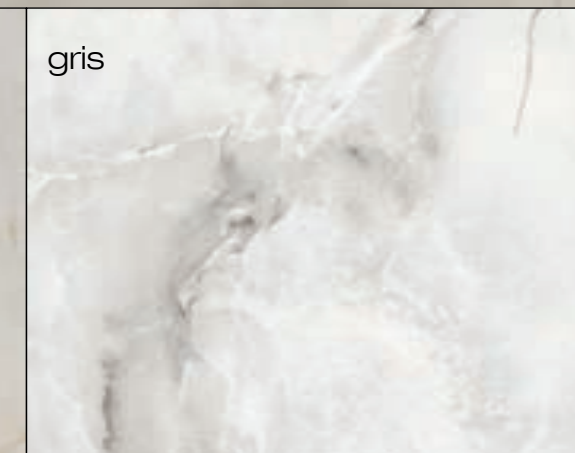

gris

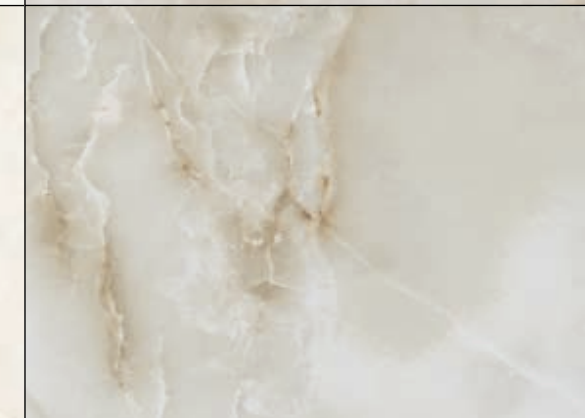

cloth



Clothy perla 60x120 / 24"x48" _ Clothy perla 120x120 / 48"x48"

clothly



pavimento _ porcelánico _ pulido _ rectificado
 floor tile _ porcelain _ polished _ rectified

Clothy gris 120x120 / 48"x48"

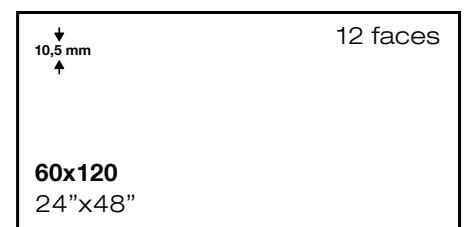
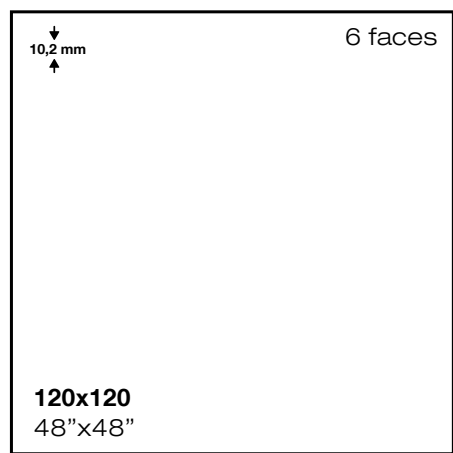

PACKING & SPECIAL PIECES

	Pc/Cj	M2/Cj	Cj/PI	M2/PI	Kg/Cj	Kg/PI		Pulido
60x120	2	1,44	32	46,08	34,25	1121	60x120	MP323
120x120	1	1,44	36	51,84	35	1300	120x120	MP333

Ver página 427
 See page 427

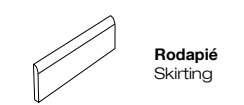

bután



Bután marengo 60x120 / 24"x48"

bután



pavimento _ porcelánico _ pulido _ rectificado
 floor tile _ porcelain _ polished _ rectified

Bután marfil 90x90 / 36"x36"

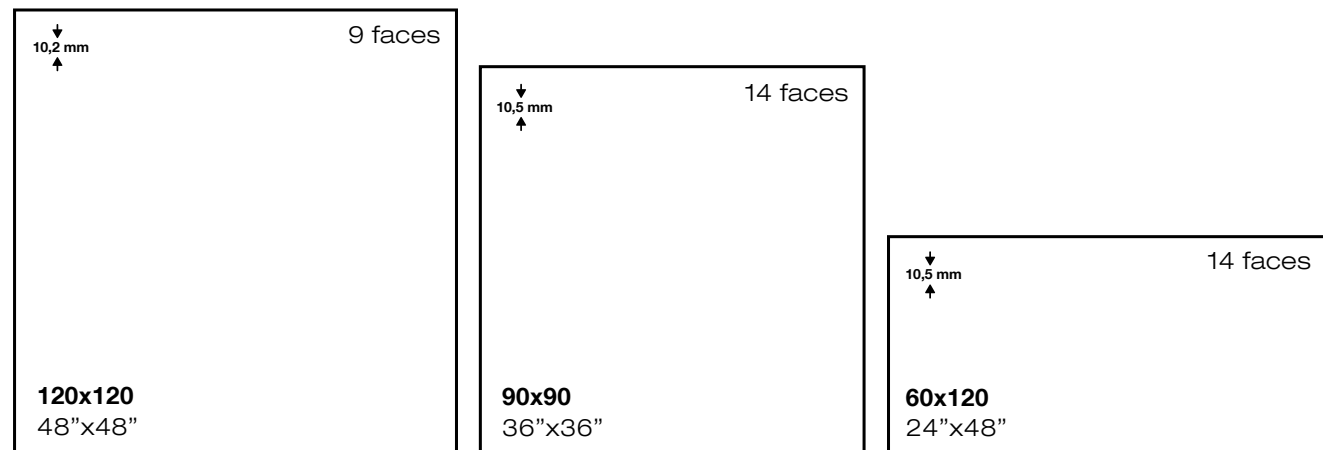

PACKING & SPECIAL PIECES

	Pc/Cj	M2/Cj	Cj/PI	M2/PI	Kg/Cj	Kg/PI
60x120	2	1,44	32	46,08	34,25	1121
90x90	2	1,62	27	43,74	40	1110
120x120	1	1,44	36	51,84	35	1300

	Pulido
60x120	MP323
90x90	MP204
120x120	MP333

Ver página 427
See page 427

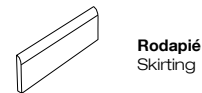

Rodapié
Skirting

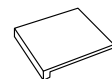

Peldaño
Step



tekali



Tekali gris 120x120 / 48"x48"

tekali



pavimento _ porcelánico _ pulido _ rectificado
 floor tile _ porcelain _ polished _ rectified

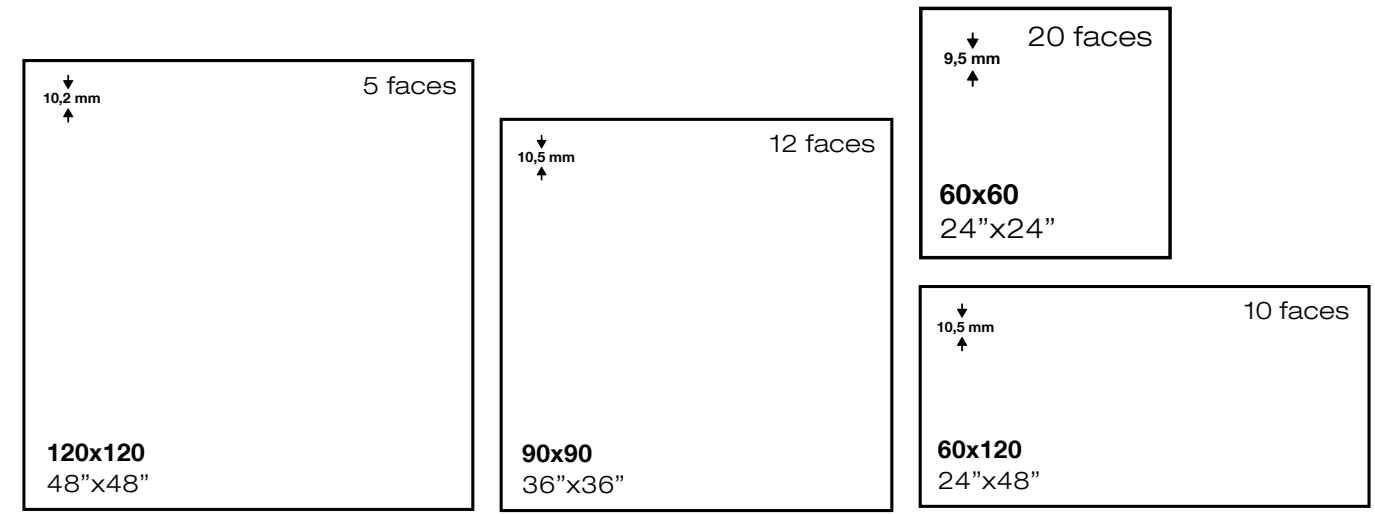

Tekali crema 60x120 / 24"x48"



PACKING & SPECIAL PIECES

	Pc/Cj	M2/Cj	Cj/PI	M2/PI	Kg/Cj	Kg/PI
60x60	4	1,44	30	43,2	31,4	962
90x90	2	1,62	27	43,74	40	1110
60x120	2	1,44	32	46,08	34,25	1121
120x120	1	1,44	36	51,84	35	1300

	Pulido
60x60	MP174
90x90	MP204
60x120	MP323
120x120	MP333

Ver página 427
See page 427



pulsar



Pulsar marfil 120x120 / 48"x48"

pulsar



pavimento _ porcelánico _ pulido _ rectificado
 floor tile _ porcelain _ polished _ rectified

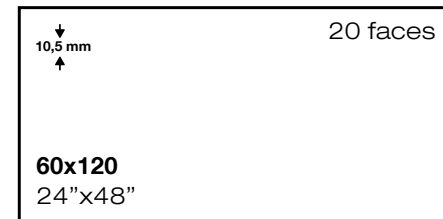
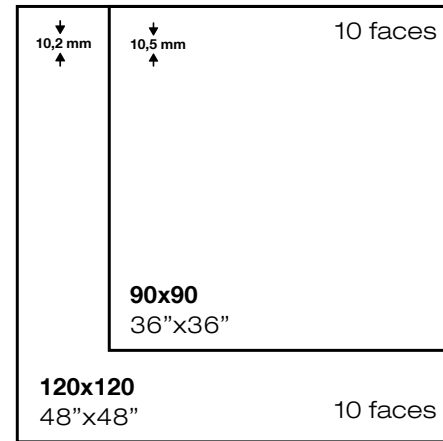

PACKING & SPECIAL PIECES

	Pc/Cj	M2/Cj	Cj/PI	M2/PI	Kg/Cj	Kg/PI
90x90	2	1,62	27	43,74	40	1110
60x120	2	1,44	32	46,08	34,25	1121
120x120	1	1,44	36	51,84	35	1300

	Pulido
90x90	MP204
60x120	MP323
120x120	MP333

Ver página 427
See page 427

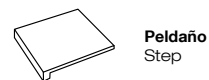

Pulsar gris 120x120 / 48"x48"



kendall



Kendall 120x120 / 48"x48"

kendall



pavimento _ porcelánico _ pulido _ rectificado
 floor tile _ porcelain _ polished _ rectified



Serie también disponible en mate.

Series also available in matt.
 Série également disponible en mat.
 Serie auch in matt erhältlich.

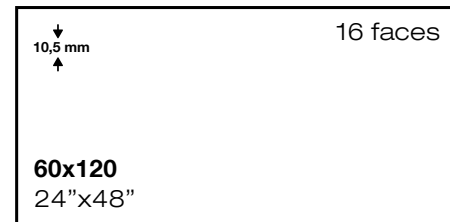

PACKING & SPECIAL PIECES

	Pc/Cj	M2/Cj	Cj/PI	M2/PI	Kg/Cj	Kg/PI
60x120	2	1,44	32	46,08	34,25	1121

	Pulido	Mate
60x120	MP323	MP320

Ver página 427
 See page 427

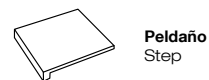
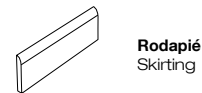

Kendall mate 60x120 / 24"x48"

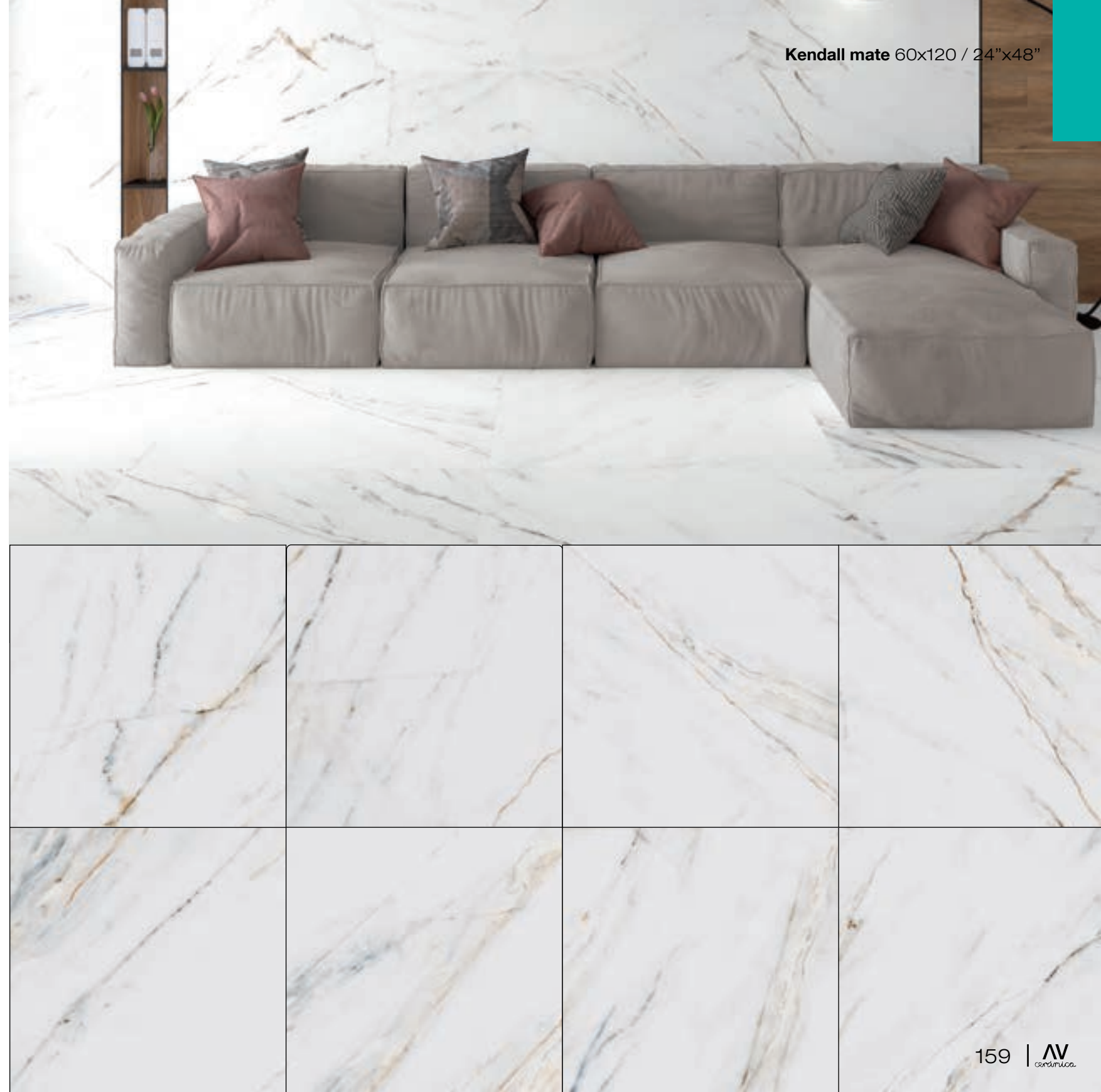



urli blue

Urli blue 120x120 / 48"x48" _ Urli blue 30x60 / 12"x24" _ Forest dark 20x120 / 8"x48"

urli blue



pavimento _ porcelánico _ pulido _ rectificado
 floor tile _ porcelain _ polished _ rectified



Serie también disponible en mate.
 Series also available in matt.
 Série également disponible en mat.
 Serie auch in matt erhältlich.

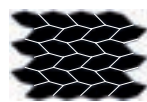

**Malla Coimbra
 Urli Blue**
 P860
 29x38 / 12"x12"

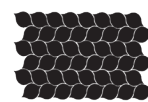

**Malla Petru
 Urli Blue**
 P857
 29x30 / 12"x12"

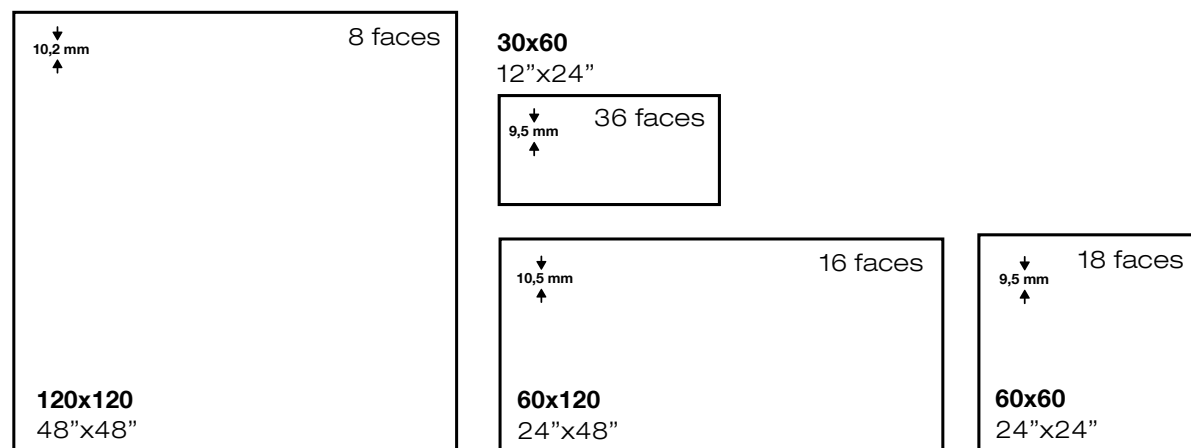

PACKING & SPECIAL PIECES

	Pc/Cj	M2/Cj	Cj/PI	M2/PI	Kg/Cj	Kg/PI
30x60	6	1,08	48	51,8	23,6	1152,8
60x60	4	1,44	30	43,2	31,4	962
60x120	2	1,44	32	46,08	34,25	1121
120x120	1	1,44	36	51,84	35	1300

	Pulido	Mate
30x60	MP124	MP126
60x60	MP174	MP175
60x120	MP323	MP320
120x120	MP333	MP330

Ver página 427
 See page 427

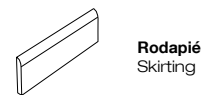

Rodapié
 Skirting

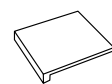

Peldaño
 Step

Urli Blue 120x120 / 48"x48" _ Urli blue 60x120 / 24"x48" _ Convec dark 60x120 / 24"x48"

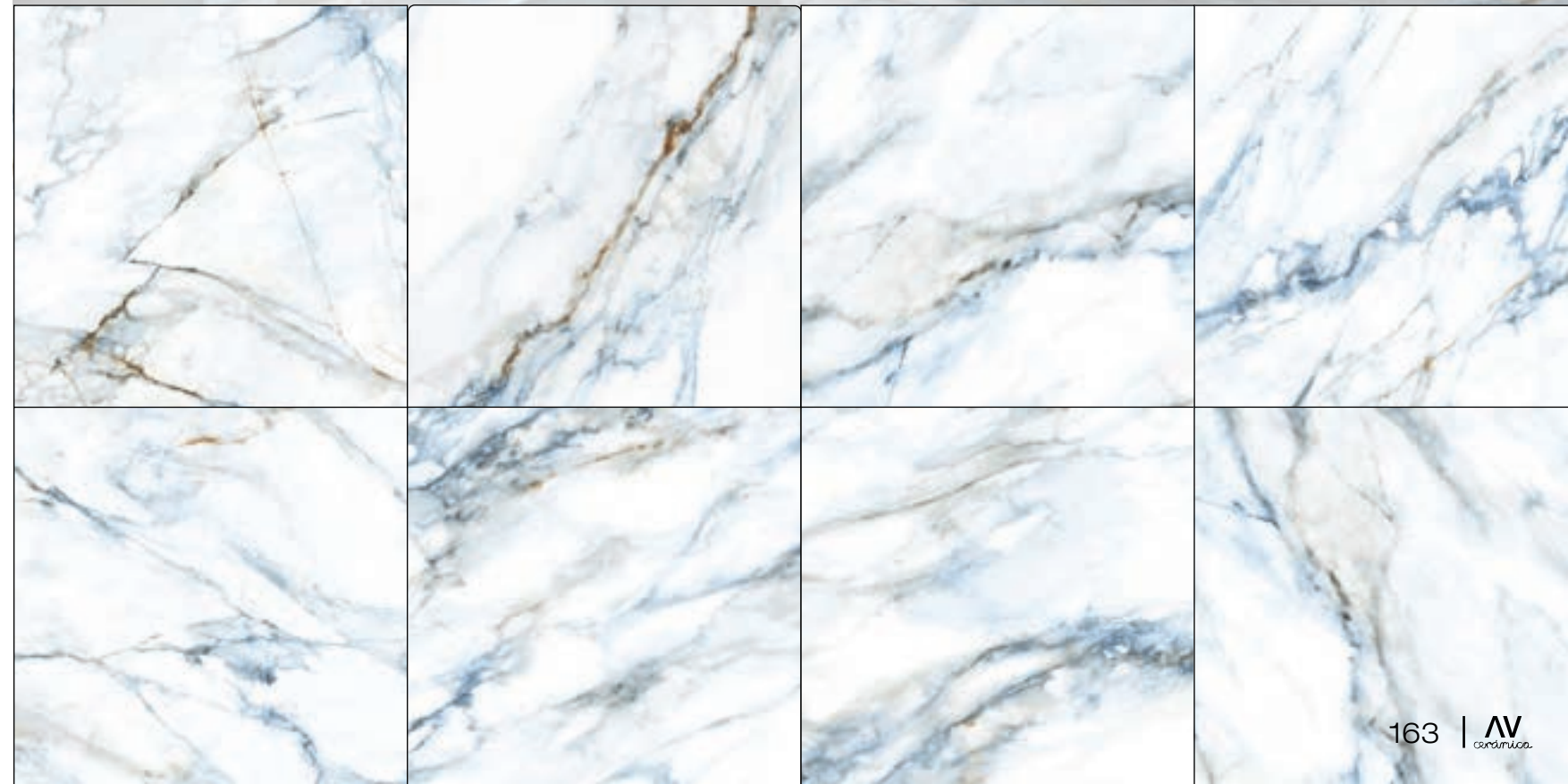

aeris



Aeris 120x120 / 48"x48"

aeris



pavimento _ porcelánico _ pulido _ rectificado
 floor tile _ porcelain _ polished _ rectified

Aeris 90x90 / 36"x36"

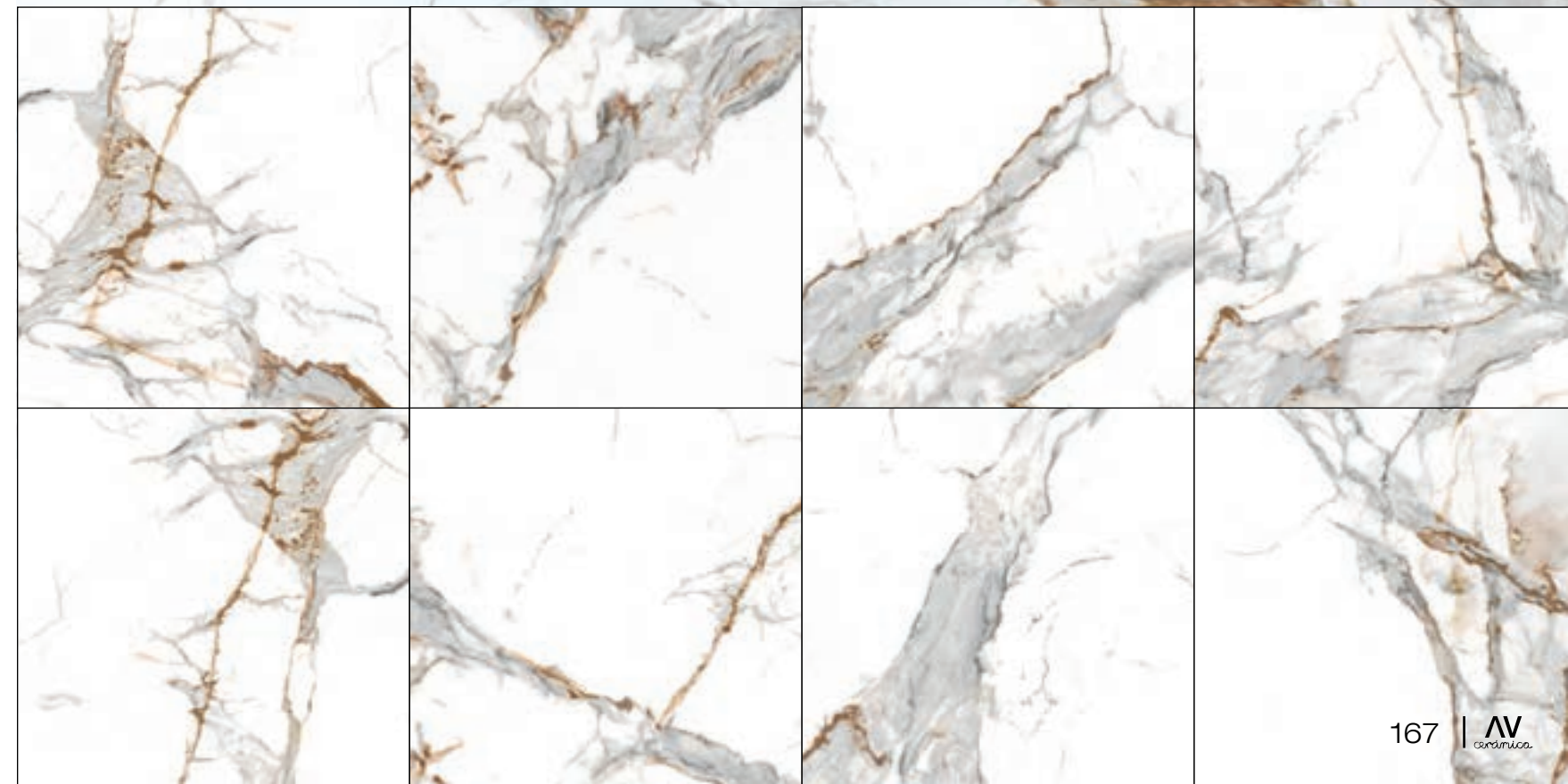
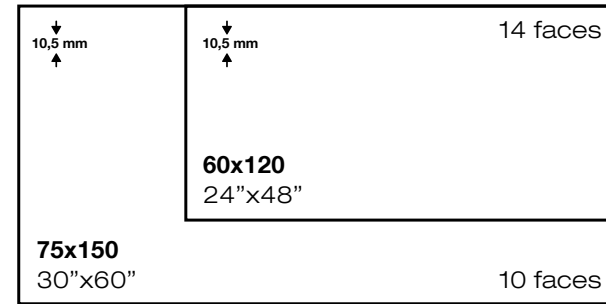
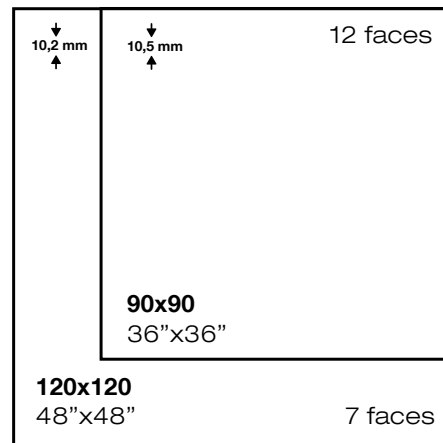

PACKING & SPECIAL PIECES

	Pc/Cj	M2/Cj	Cj/PI	M2/PI	Kg/Cj	Kg/PI
60x120	2	1,44	32	46,08	34,25	1121
90x90	2	1,62	27	43,74	40	1110
120x120	1	1,44	36	51,84	35	1300
75x150	1	1,13	40	45,2	28	1184

	Pulido
60x120	MP323
90x90	MP204
120x120	MP333
75x150	MP343

Ver página 427
See page 427

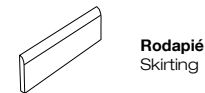

Rodapié
Skirting

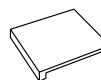

Peldaño
Step

golden



Golden 90x90 / 36"x36"

golden



pavimento _ porcelánico _ pulido _ rectificado
 floor tile _ porcelain _ polished _ rectified



Formatos 30x60, 60x60 y 60x120 también disponibles en mate.
 Sizes 30x60, 60x60 and 60x120 also available in matt.
 Formats 30x60, 60x60 et 60x120 également disponible en mat.
 Formate 30x60, 60x60 und 60x120 auch in matt erhältlich.

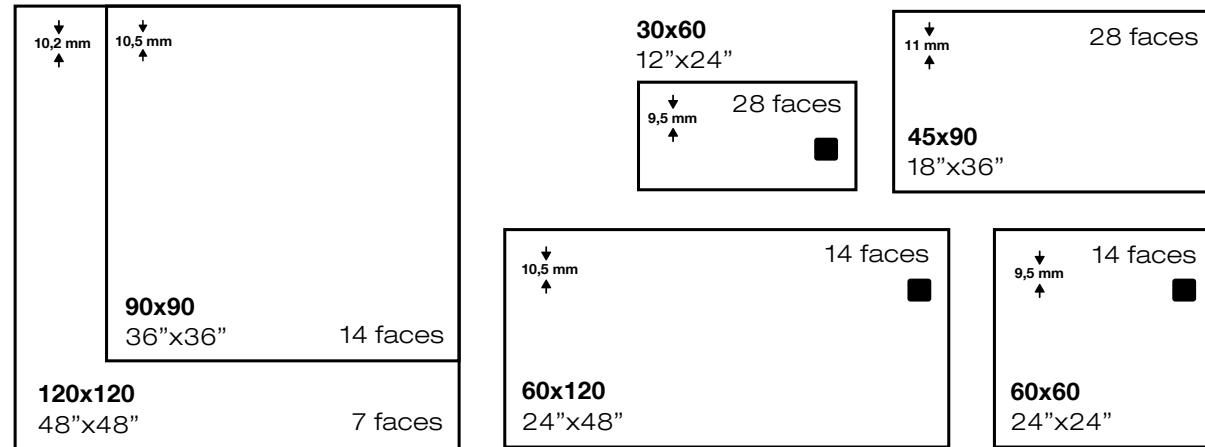

PACKING & SPECIAL PIECES

	Pc/Cj	M2/Cj	Cj/PI	M2/PI	Kg/Cj	Kg/PI
30x60	6	1,08	48	51,8	23,6	1152,8
45x90	3	1,21	44	53,24	28,7	1282,8
60x60	4	1,44	30	43,2	31,4	962
90x90	2	1,62	27	43,74	40	1110
60x120	2	1,44	32	46,08	34,25	1121
120x120	1	1,44	36	51,84	35	1300

	Pulido	Mate
30x60	MP124	MP126
45x90	MP310	-
60x60	MP174	MP175
90x90	MP204	-
60x120	MP323	MP320
120x120	MP333	-

Ver página 427
 See page 427



Rodapié
 Skirting

Peldaño
 Step

Golden 60x120 / 24"x48"



tyra

Tyra 120x120 / 48"x48"

tyra



pavimento _ porcelánico _ pulido _ rectificado
 floor tile _ porcelain _ polished _ rectified

Serie también disponible en mate.
 Series also available in matt.
 Série également disponible en mat.
 Serie auch in matt erhältlich.

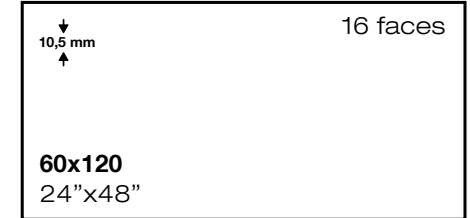
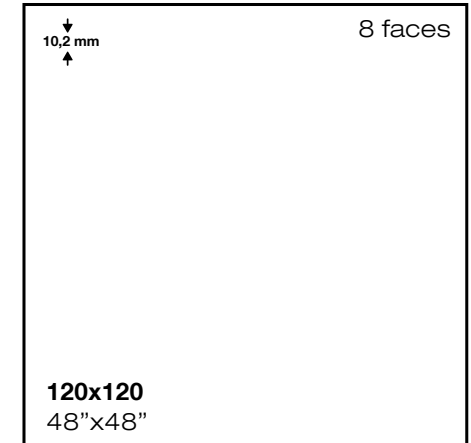

PACKING & SPECIAL PIECES

	Pc/Cj	M2/Cj	Cj/PI	M2/PI	Kg/Cj	Kg/PI
60x120	2	1,44	32	46,08	34,25	1121
120x120	1	1,44	36	51,84	35	1300

	Pulido	Mate
60x120	MP323	MP320
120x120	MP333	MP330

Ver página 427
 See page 427

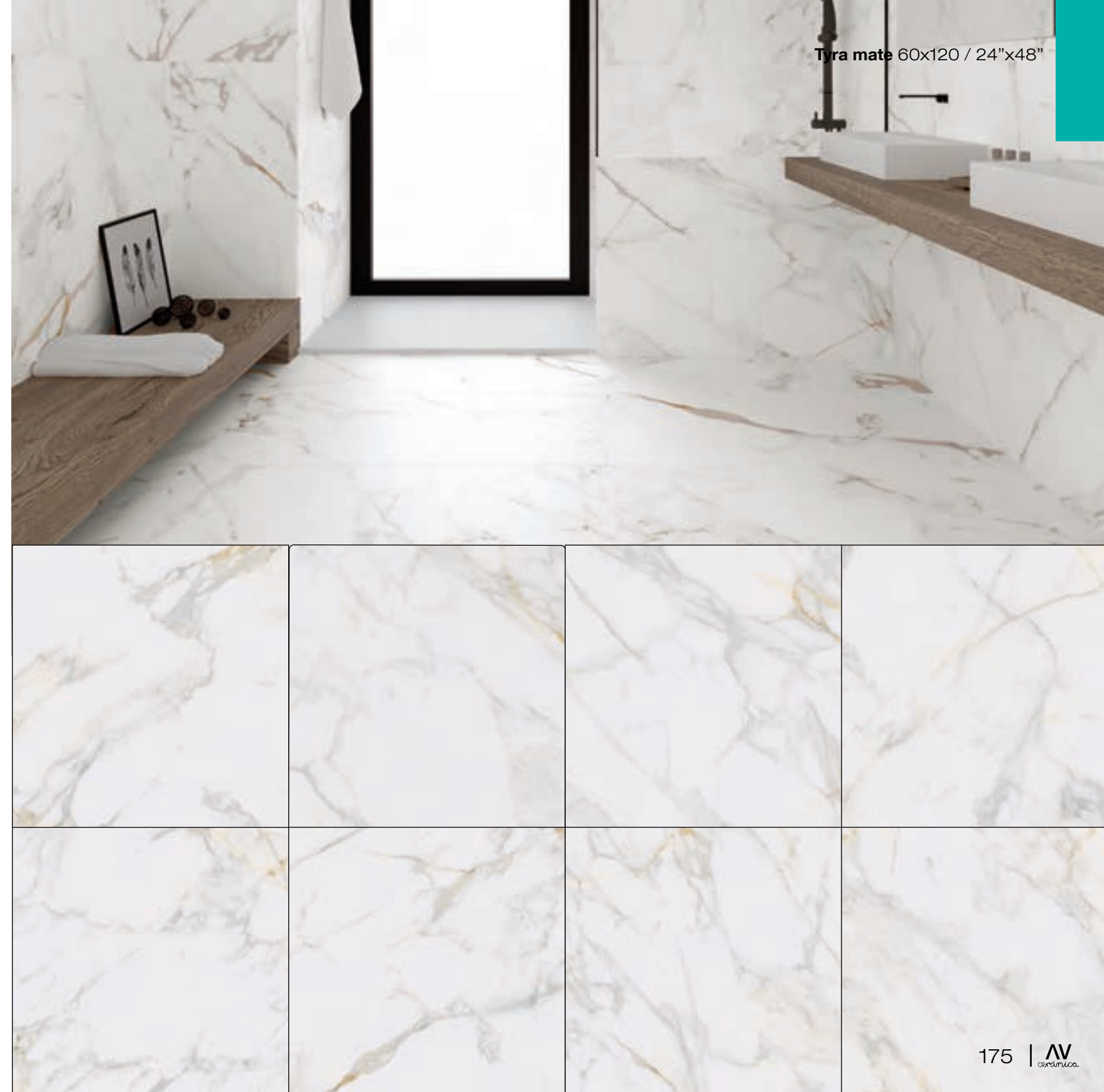

Tyra mate 60x120 / 24"x48"



lance

Lance 60x120 / 24"x48" _ Taiga noce 20x120 / 8"x48"

lance



pavimento _ porcelánico _ pulido _ rectificado
 floor tile _ porcelain _ polished _ rectified



Serie también disponible en mate.
 Series also available in matt.
 Série également disponible en mat.
 Serie auch in matt erhältlich.

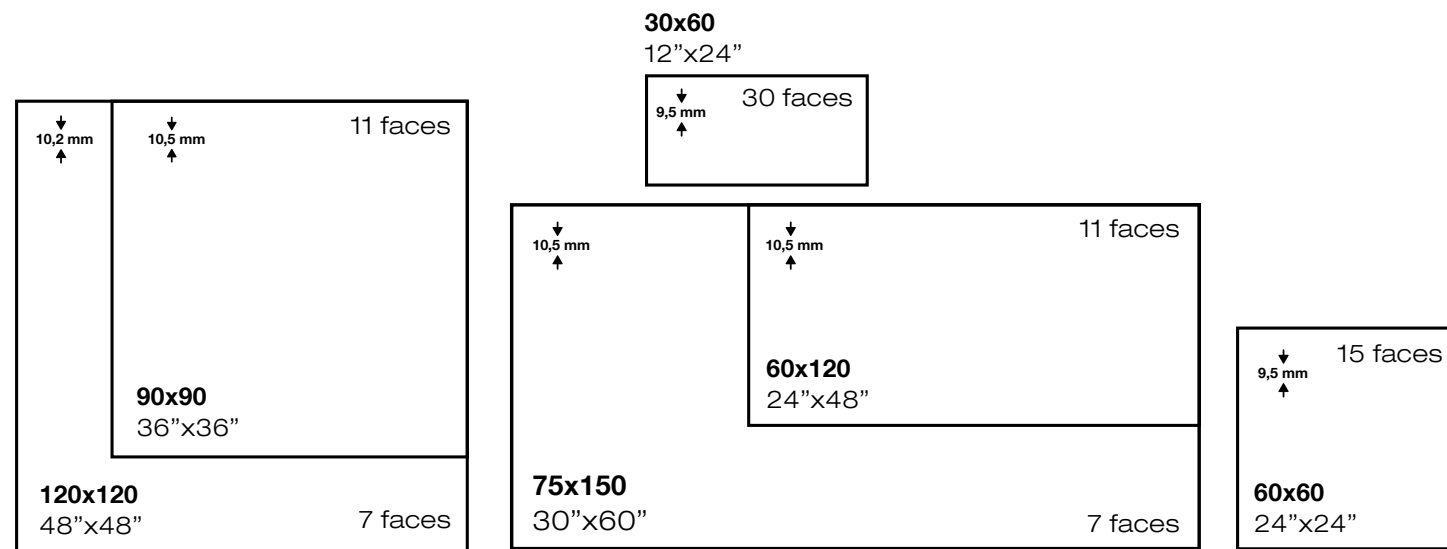

PACKING & SPECIAL PIECES

	Pc/Cj	M2/Cj	Cj/PI	M2/PI	Kg/Cj	Kg/PI
30x60	6	1,08	48	51,8	23,6	1152,8
60x60	4	1,44	30	43,2	31,4	962
90x90	2	1,62	27	43,74	40	1110
60x120	2	1,44	32	46,08	34,25	1121
120x120	1	1,44	36	51,84	35	1300
75x150	1	1,13	40	45,2	28	1184

	Pulido	Mate
30x60	MP124	MP126
60x60	MP174	MP175
90x90	MP204	MP207
60x120	MP323	MP320
120x120	MP333	MP330
75x150	MP343	MP340

Ver página 427
 See page 427



Lance mate 120x120 / 48"x48"





MARMOL / MARBLE

lindsay

Lindsay 60x120 / 24"x48"

lindsay



pavimento _ porcelánico _ pulido _ rectificado
 floor tile _ porcelain _ polished _ rectified



Serie también disponible en mate.
 Series also available in matt.
 Série également disponible en mat.
 Serie auch in matt erhältlich.

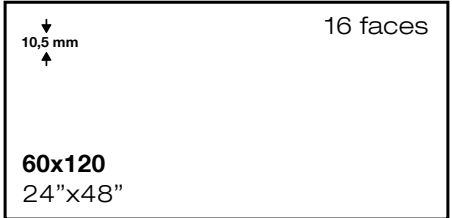

PACKING & SPECIAL PIECES

	Pc/Cj	M2/Cj	Cj/PI	M2/PI	Kg/Cj	Kg/PI
60x120	2	1,44	32	46,08	34,25	1121

	Pulido	Mate
60x120	MP323	MP320

Ver página 427
See page 427



Lindsay mate 60x120 / 24"x48" _ Cima negro 13x15 / 5"x6"

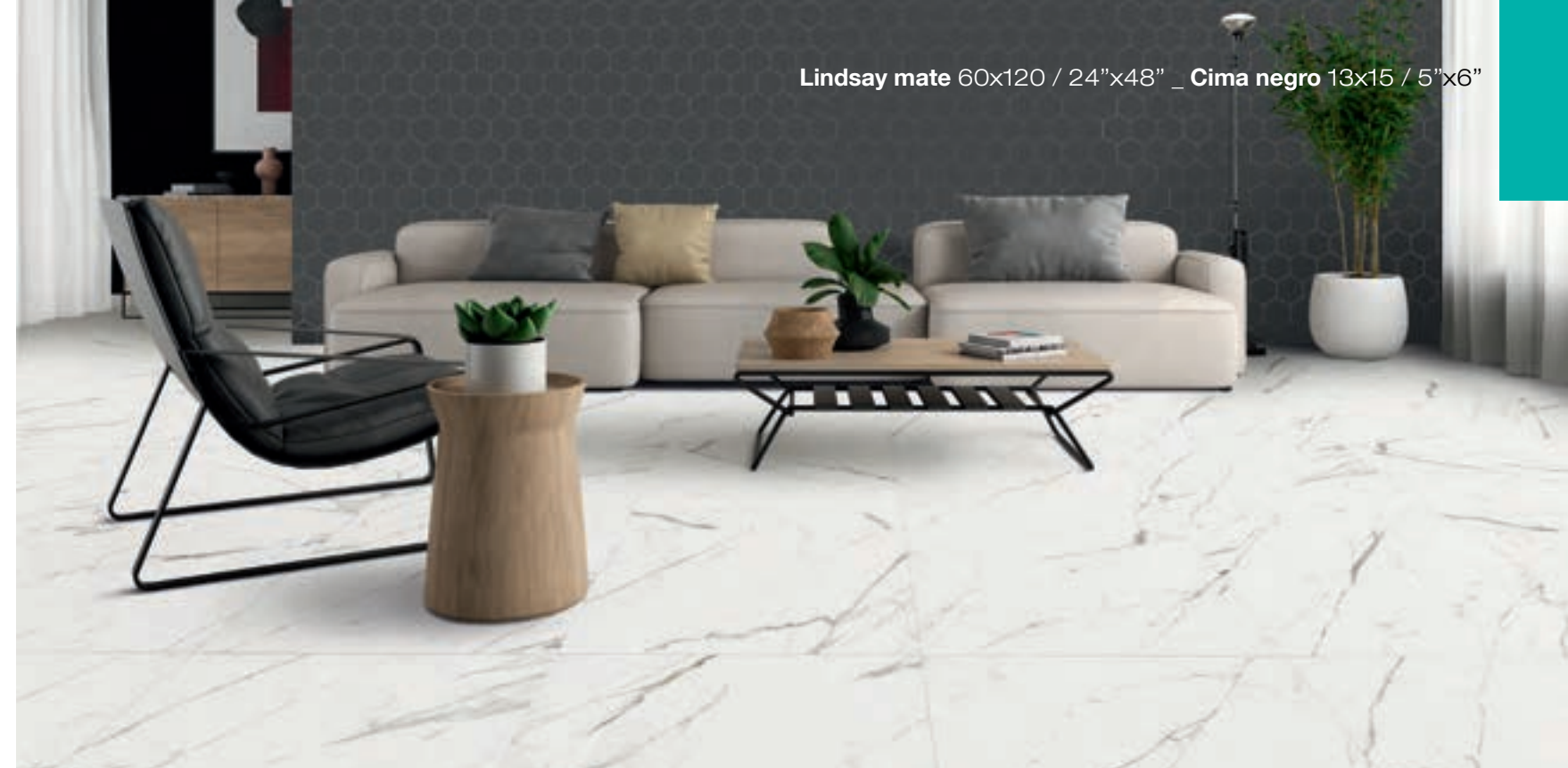

viterbo



Viterbo blanco 120x120 / 48"x48"

viterbo



pavimento _ porcelánico _ pulido _ rectificado
 floor tile _ porcelain _ polished _ rectified

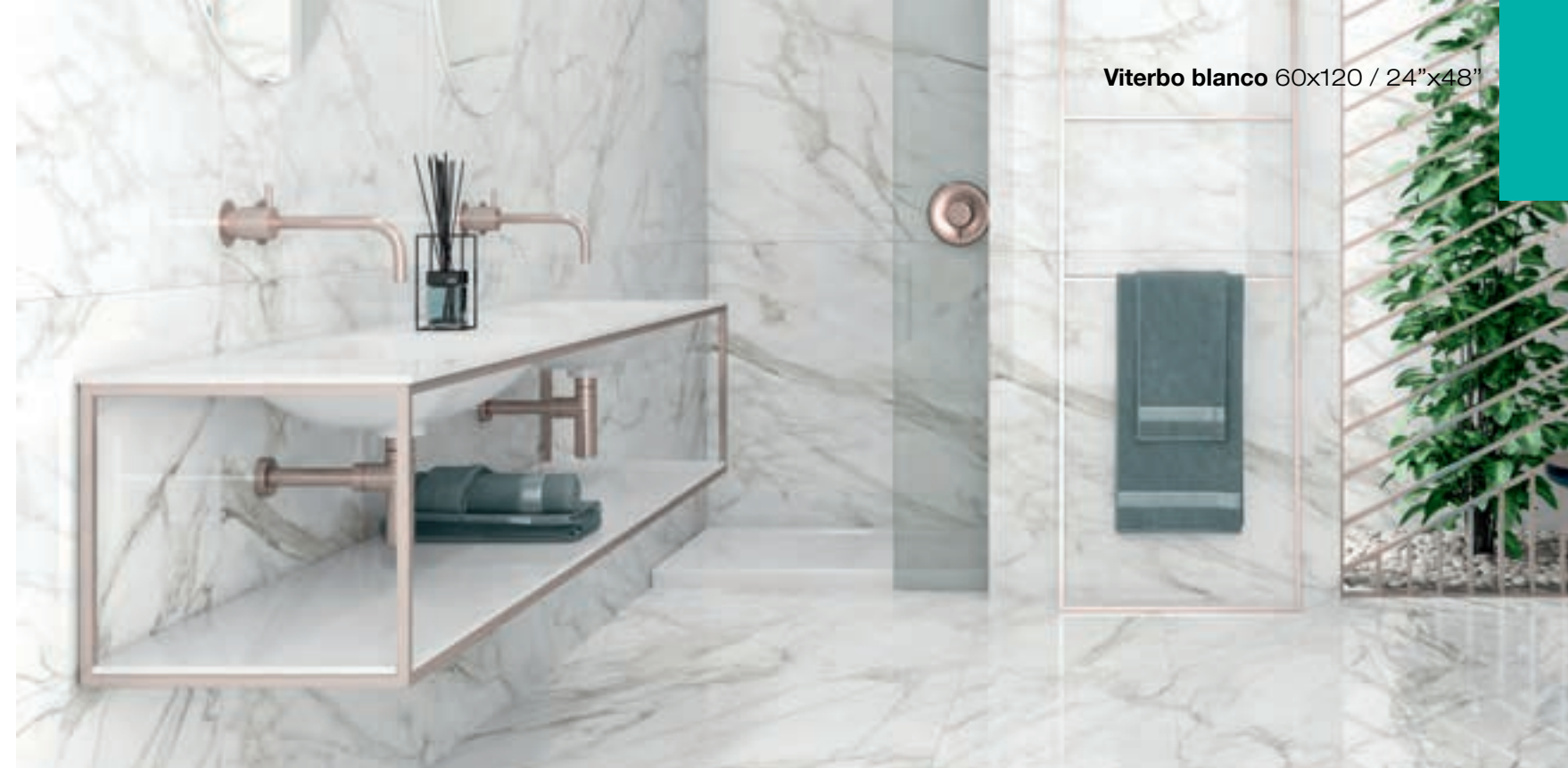
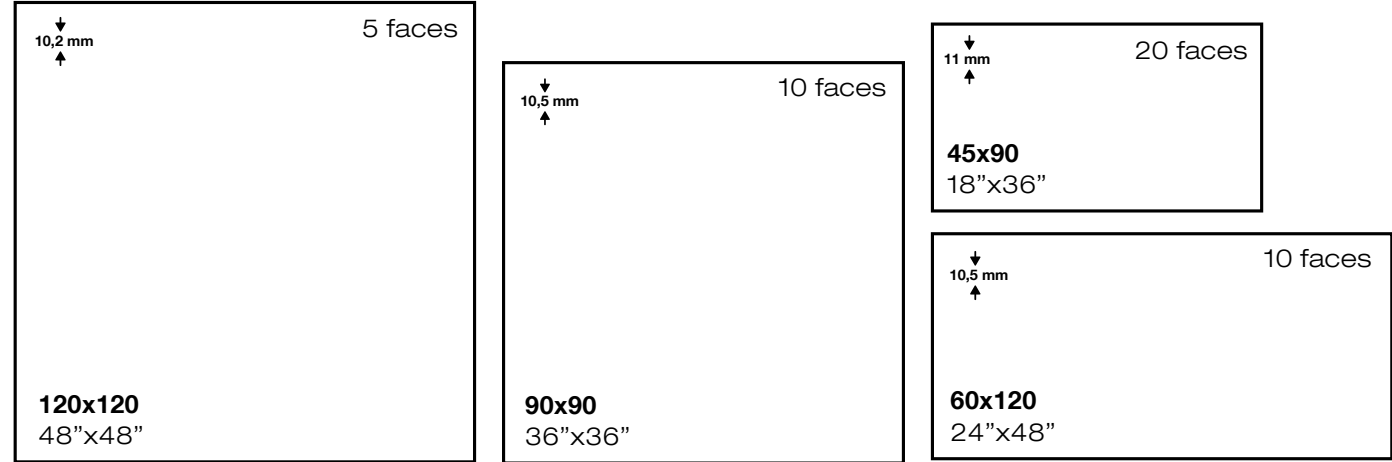

Viterbo blanco 60x120 / 24"x48"

PACKING & SPECIAL PIECES

	Pc/Cj	M2/Cj	Cj/PI	M2/PI	Kg/Cj	Kg/PI
45x90	3	1,21	44	53,24	28,7	1282,8
90x90	2	1,62	27	43,74	40	1110
60x120	2	1,44	32	46,08	34,25	1121
120x120	1	1,44	36	51,84	35	1300

	Pulido
45x90	MP310
90x90	MP204
60x120	MP323
120x120	MP333

Ver página 427
See page 427



blanco

zoey



Zoey mate 120x120 / 48"x48"

zoey



pavimento _ porcelánico _ pulido _ rectificado
 floor tile _ porcelain _ polished _ rectified



Serie también disponible en mate.

Series also available in matt.

Série également disponible en mat.

Serie auch in matt erhältlich.

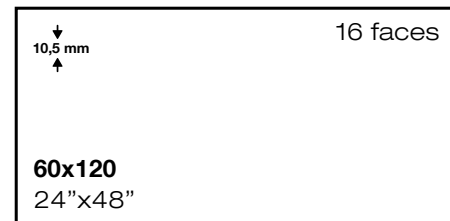
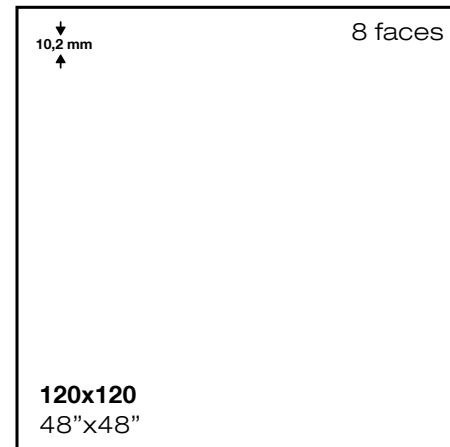

PACKING & SPECIAL PIECES

	Pc/Cj	M2/Cj	Cj/PI	M2/PI	Kg/Cj	Kg/PI
60x120	2	1,44	32	46,08	34,25	1121
120x120	1	1,44	36	51,84	35	1300

	Pulido	Mate
60x120	MP323	MP320
120x120	MP333	MP330

Ver página 427
See page 427

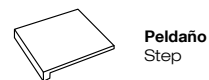
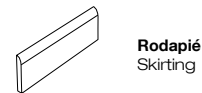

Zoey 120x120 / 48"x48"



uyuni



Uyuni 60x120 / 24"x48" _ Uyuni 120x120 / 48"x48"

uyuni



pavimento _ porcelánico _ pulido _ rectificado
 floor tile _ porcelain _ polished _ rectified



Serie también disponible en mate.

Series also available in matt.

Série également disponible en mat.

Serie auch in matt erhältlich.

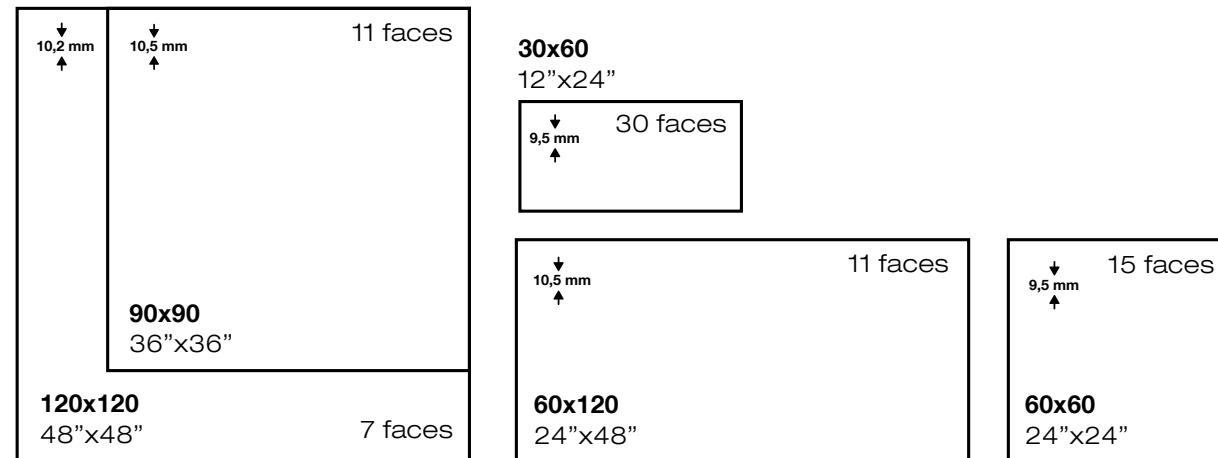

PACKING & SPECIAL PIECES

	Pc/Cj	M2/Cj	Cj/PI	M2/PI	Kg/Cj	Kg/PI
30x60	6	1,08	48	51,8	23,6	1152,8
60x60	4	1,44	30	43,2	31,4	962
90x90	2	1,62	27	43,74	40	1110
60x120	2	1,44	32	46,08	34,25	1121
120x120	1	1,44	36	51,84	35	1300

	Pulido	Mate
30x60	MP124	MP126
60x60	MP174	MP175
90x90	MP204	MP207
60x120	MP323	MP320
120x120	MP333	MP330

 **Ver página 427**
See page 427

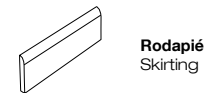

Rodapié
Skirting

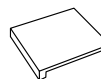

Peldaño
Step

Uyuni 60x120 / 24"x48"



aura /riola



Aura 120x120 / 48"x48"

aura[®] / riola[®]



pavimento _ porcelánico _ pulido _ mate _ rectificado
 floor tile _ porcelain _ polished _ matt _ rectified

Riola 60x120 / 24"x48"

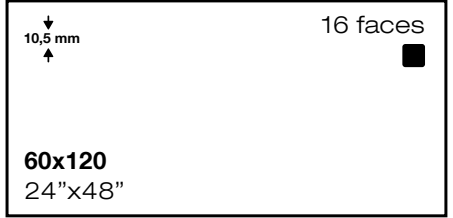
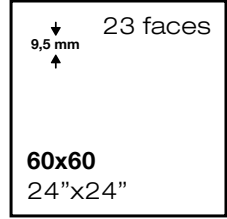
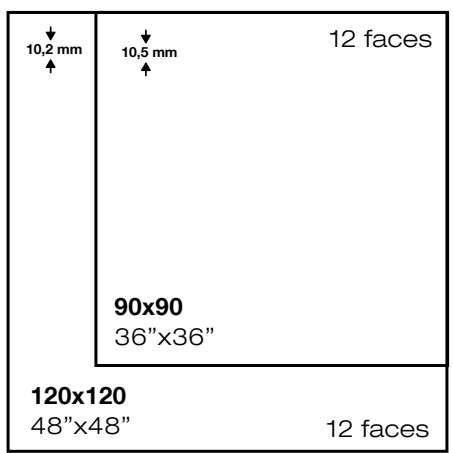

PACKING & SPECIAL PIECES

	Pc/Cj	M2/Cj	Cj/PI	M2/PI	Kg/Cj	Kg/PI
60x60	4	1,44	30	43,2	31,4	962
60x120	2	1,44	32	46,08	34,25	1121
90x90	2	1,62	27	43,74	40	1110
120x120	1	1,44	36	51,84	35	1300

	Pulido	Mate
60x60	MP174	-
60x120	MP323	MP320
90x90	MP204	-
120x120	MP333	-

Ver página 427
See page 427



forum



Forum 60x120 / 24"x48"

forum



pavimento _ porcelánico _ pulido _ rectificado
 floor tile _ porcelain _ polished _ rectified

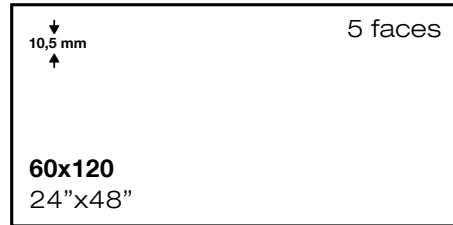

PACKING & SPECIAL PIECES

	Pc/Cj	M2/Cj	Cj/PI	M2/PI	Kg/Cj	Kg/PI
60x120	2	1,44	32	46,08	34,25	1121

	Pulido
60x120	MP323

Ver página 427
See page 427

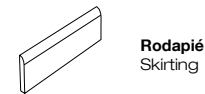

Forum 60x120 / 24"x48"

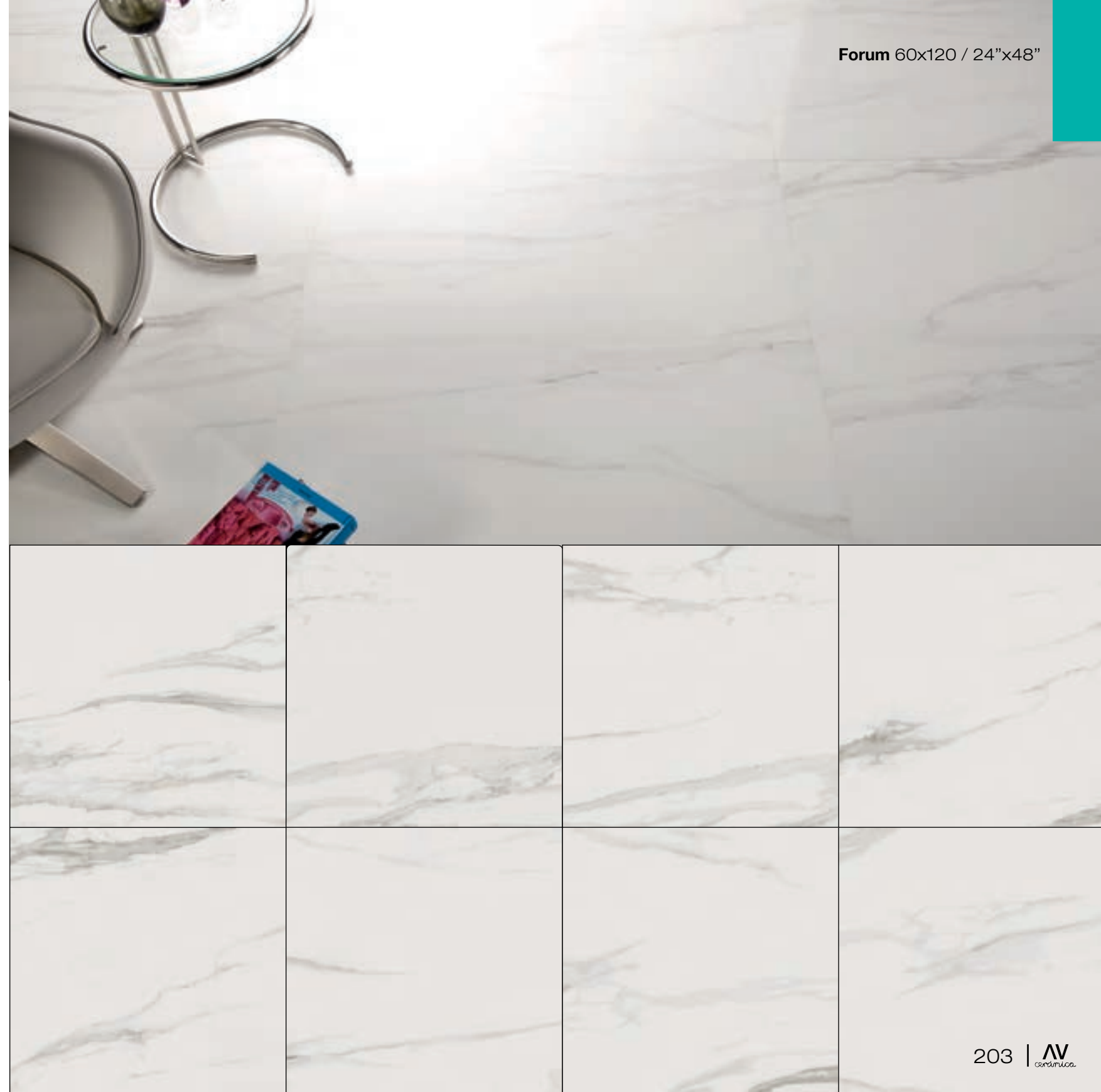

bruce



Bruce matt 60x60 / 24"x24"

bruce



pavimento _ porcelánico _ pulido _ rectificado
 floor tile _ porcelain _ polished _ rectified



Serie disponible en mate excepto en formato 90x180.
 Series available in matt except 90x180 size.
 Série disponible en mat sauf format 90x180.
 Serien in matt erhältlich außer Format 90x180.

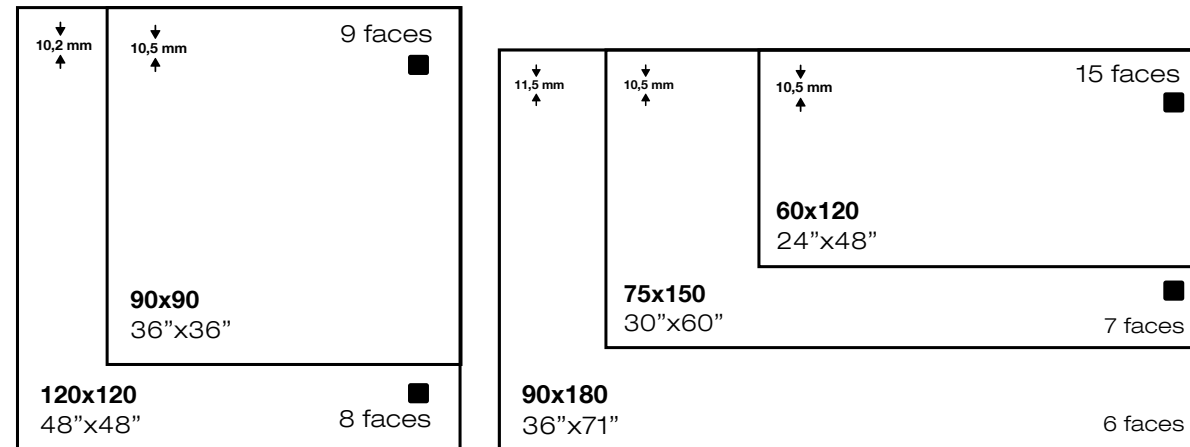

Bruce polished 90x90 / 36"x36"

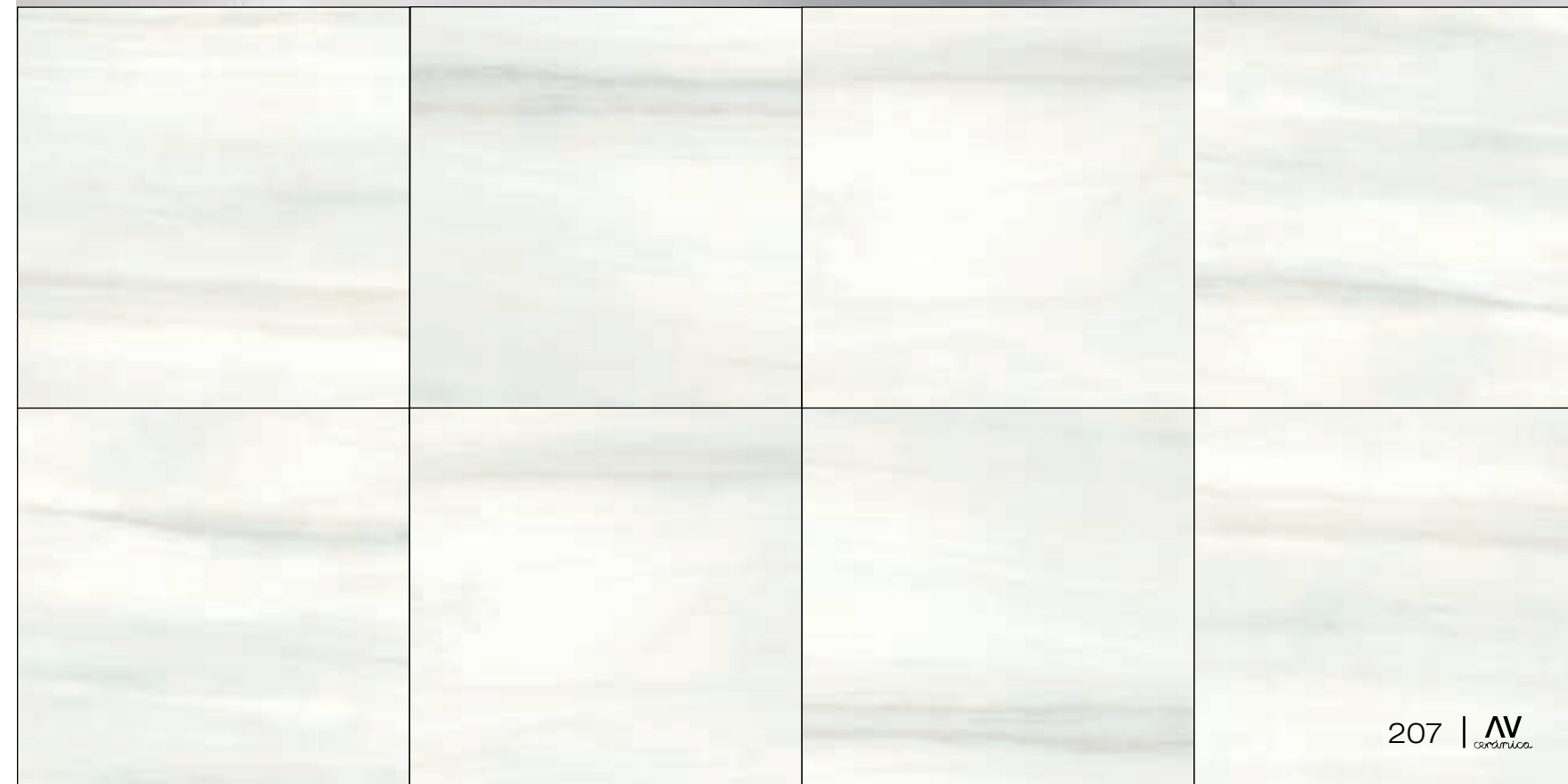

PACKING & SPECIAL PIECES

	Pc/Cj	M2/Cj	Cj/PI	M2/PI	Kg/Cj	Kg/PI
60x120	2	1,44	32	46,08	34,25	1121
90x90	2	1,62	27	43,74	40	1110
120x120	1	1,44	36	51,84	35	1300
75x150	1	1,13	40	45,2	28	1184
90x180	1	1,62	24	38,8	42	1068

	Pulido	Mate
60x120	MP323	MP320
90x90	MP204	MP207
120x120	MP333	MP330
75x150	MP343	MP340
90x180	MP352	-

Ver página 427
See page 427



Rodapié
Skirting

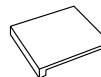

Peldaño
Step

Lugano



Lugano marfil 60x120 / 24"x48"

lugano



pavimento _ porcelánico _ pulido _ rectificado
 floor tile _ porcelain _ polished _ rectified

Lugano marfil 75x75 / 30"x30"

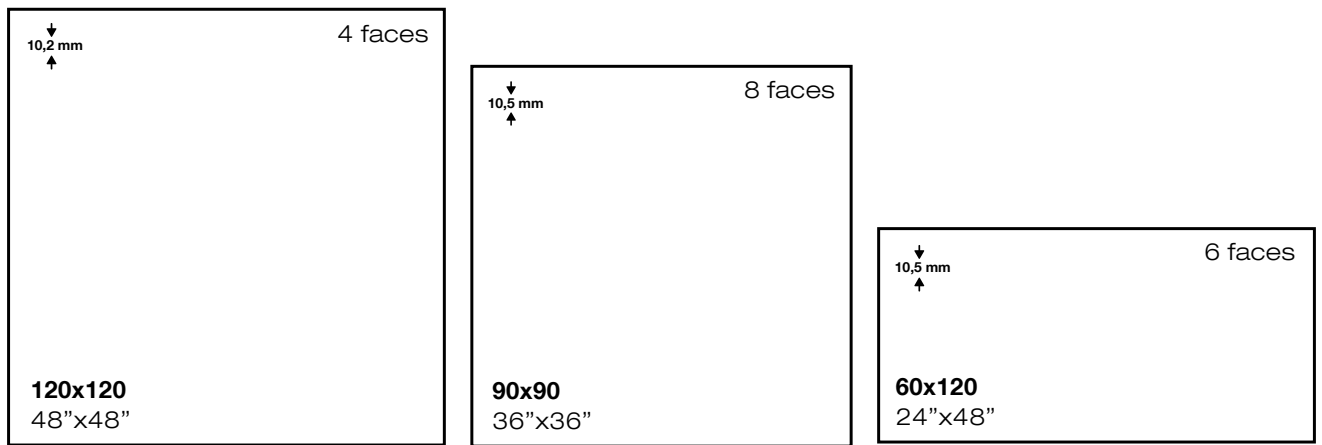

PACKING & SPECIAL PIECES

	Pc/Cj	M2/Cj	Cj/PI	M2/PI	Kg/Cj	Kg/PI		
90x90	2	1,62	27	43,74	40	1110	Pulido	
60x120	2	1,44	32	46,08	34,25	1121	90x90	MP204
120x120	1	1,44	36	51,84	35	1300	60x120	M323
							120x120	MP333

Ver página 427
See page 427

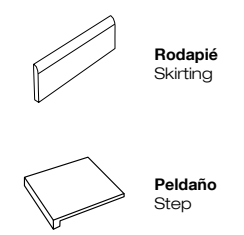

ES

Intentando mantener la calidez de las maderas naturales, tanto los tonos como sus vetas e imperfecciones y con la dureza del porcelánico.

EN

In an attempt to maintain the warmth of natural woods, both the tones, grains and imperfections with the hardness of porcelain.

FR

Essayer de conserver la chaleur des bois naturels, tant dans les tons que dans leurs grains et imperfections, ainsi que dans la dureté de la porcelaine.

DE

Wir versuchen, die Wärme natürlicher Hölzer, sowohl die Farbtöne als auch ihre Maserung und Unvollkommenheiten, sowie die Härte von Porzellan beizubehalten.

W P
WOOD PORCELAIN

BOSCO • UMBRIA • WILLOW • MADEIRA • DECK • FOREST
BOLZANO • MEDINA • MAKAI • TAIGA • FANLO

bolzano



GRUPO Bla **Recomendable no colocar trabado a mitad de pieza / We do not recommend to lay the tiles brickbond (brick-jointed) halfway**

Formato 20x120 susceptible de tratamiento antideslizante bajo demanda. Format 20x120 susceptible to anti-slip treatment on request. Format 20x120 sensible au traitement antidérapant sur demande. Format 20x120 mit Antirutschbehandlung auf Anfrage.

Bolzano 20x120 grey y natural se pueden suministrar antideslizantes. Bolzano 20x120 grey and natural colors from collection can be produced on antislip finish. Bolzano 20x120 grey et natural peuvent être livrés en finition rectifié sur commande. Bolzano 20x120 grey und natural kann in rutschhemmender Ausführung geliefert werden.

9 mm **34 faces**

20x120
8"x48"

10,5 mm **32 faces**

25x150
10"x59"

PACKING & SPECIAL PIECES

Ver página 428
See page 428

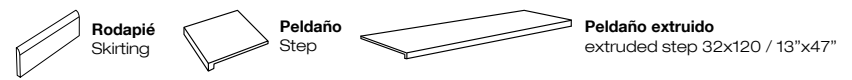

	Pc/Cj	M2/Cj	Cj/PI	M2/PI	Kg/Cj	Kg/PI
20x120	7	1,68	44	73,92	32	1437
25x150	4	1,5	40	60	35	1430

	Cód.	ADZ
20x120	MP225	MP226
25x150	MP235	-
32x120	P061	-



Bolzano natural 20x120 / 8"x48"

taiga



GRUPO
Bla

Recomendable no colocar trabado a mitad de pieza /
We do not recommend to lay the tiles brickbond
(brick-jointed) halfway

Formato 20x120 susceptible de tratamiento antideslizante bajo demanda.
Format 20x120 susceptible to anti-slip treatment on request.
Format 20x120 sensible au traitement antidérapant sur demande.
Format 20x120 mit Antirutschbehandlung auf Anfrage.

↓ 9 mm ↑ 15 faces

20x120
8"x48"

↓ 10,5 mm ↑ 10 faces

25x150
10"x59"

PACKING & SPECIAL PIECES

Ver página 428
See page 428



Rodapié
Skirting

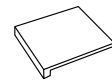

Peldaño
Step

	Pc/Cj	M2/Cj	Cj/PI	M2/PI	Kg/Cj	Kg/PI
20x120	7	1,68	44	73,92	32	1437
25x150	4	1,5	40	60	35	1430

Cód.

20x120 MP225

25x150 MP235



Taiga blanco 20x120 / 8"x48"

blanco

gris

crema

nogal

noce

fanlo



GRUPO
B1a



Recomendable no colocar trabado a mitad de pieza /
We do not recommend to lay the tiles brickbond
(brick-jointed) halfway



25x150
10"x59"

PACKING & SPECIAL PIECES

Ver página 428
See page 428

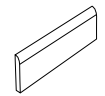

Rodapié
Skirting

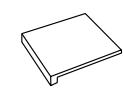

Peldaño
Step

	Pc/Cj	M2/Cj	Cj/PI	M2/PI	Kg/Cj	Kg/PI
25x150	4	1,5	40	60	35	1430

	Cód.
25x150	MP235



ceniza

haya

roble

nogal

Fanlo haya 25x150 / 10"x59"

deck



GRUPO
Bla

Recomendable no colocar trabado a mitad de pieza /
We do not recommend to lay the tiles brickbond
(brick-jointed) halfway

Serie susceptible de tratamiento antideslizante bajo demanda.
Series susceptible to anti-slip treatment on request.
Série sensible au traitement antidérapant sur demande.
Serie mit Antirutschbehandlung auf Anfrage.

Deck natural, roble y gris se pueden suministrar antideslizantes.
Deck natural, roble and gris colors from collection can be produced on antislip finish.
Deck natural, roble et gris peuvent être livrés en finition antidérapant sur commande.
Deck natural, roble und gris kann in rutschhemmender Ausführung geliefert werden.

8,2 mm 19 faces

20x75
8"x30"

9 mm 15 faces

20x120
8"x48"

PACKING & SPECIAL PIECES

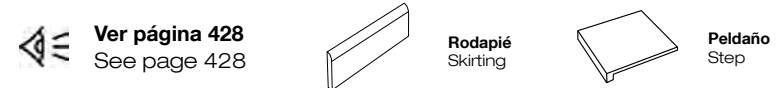

	Pc/Cj	M2/Cj	Cj/PI	M2/PI	Kg/Cj	Kg/PI
20x75	7	1,05	72	75,6	18,5	1352
20x120	7	1,68	44	73,92	32	1437

	Cód.	ADZ
20x75	MP210	MP226
20x120	MP225	-



Deck natural 20x120 / 8"x48"

roble

nogal

cerezo

gris

natural

ceniza

forest



GRUPO
Bla **Recomendable no colocar trabado a mitad de pieza / We do not recommend to lay the tiles brickbond (brick-jointed) halfway**

Serie susceptible de tratamiento antideslizante bajo demanda excepto el color antracita.
Series susceptible to anti-slip treatment on request except anthracite color.
Série susceptible de traitement antidérapant sur demande sauf couleur anthracite.
Serie mit Antirutschbehandlung auf Anfrage, außer Farbe Anthrazit.

Forest perla y light 20x75 se pueden suministrar antideslizantes.
Forest perla and light colors 20x75 from collection can be produced on antislip finish.
Forest perla et light 20x75 peuvent être livrés en finition rectifié sur commande.
Forest perla und light 20x75 tkann in rutschhemmender Ausführung geliefert werden.

↓ 8,2 mm ↑ 18 faces

20x75
8"x30"

↓ 9 mm ↑ 15 faces

20x120
8"x48"

PACKING & SPECIAL PIECES

Ver página 428
See page 428

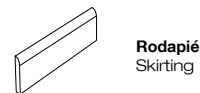

Rodapié
Skirting

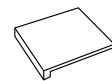

Peldaño
Step

	Pc/Cj	M2/Cj	Cj/PI	M2/PI	Kg/Cj	Kg/PI
20x75	7	1,05	72	75,6	18,5	1352
20x120	7	1,68	44	73,92	32	1437

	Cód.	ADZ
20x75	MP210	MP211
20x120	MP225	MP226



Forest dark 20x75 / 8"x30"

white

perla

light

dark

antracita

medina



GRUPO
Bla **Recomendable no colocar trabado a mitad de pieza /**
We do not recommend to lay the tiles brickbond
(brick-jointed) halfway

Serie susceptible de tratamiento antideslizante bajo demanda.
Series susceptible to anti-slip treatment on request.
Série sensible au traitement antidérapant sur demande.
Serie mit Antirutschbehandlung auf Anfrage.

Medina ceniza y natural se pueden suministrar antideslizantes.
Medina ceniza and natural colors from collection can be produced on antislip finish.
Medina ceniza et natural peuvent être livrés en finition rectifié sur commande.
Medina ceniza und natural kann in rutschhemmender Ausführung geliefert werden.

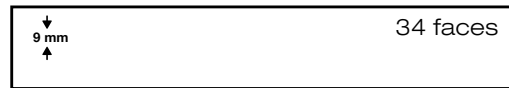

20x120
8"x48"

PACKING & SPECIAL PIECES

Ver página 428
See page 428



Rodapié
Skirting

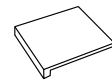

Peldaño
Step

	Pc/Cj	M2/Cj	Cj/PI	M2/PI	Kg/Cj	Kg/PI
20x120	7	1,68	44	73,92	32	1437

	Cód.	ADZ
20x120	MP225	MP226



Medina natural 20x120 / 8"x48"

ceniza

haya

nogal

natural

taupe

cerezo

makai



GRUPO
Bla

Recomendable no colocar trabado a mitad de pieza /
We do not recommend to lay the tiles brickbond
(brick-jointed) halfway

Serie susceptible de tratamiento antideslizante bajo demanda.
Series susceptible to anti-slip treatment on request.
Série sensible au traitement antidérapant sur demande.
Serie mit Antirutschbehandlung auf Anfrage.

Makai straw, roble y gris se pueden suministrar antideslizantes.
Makai straw, roble and gris colors from collection can be produced on antislip finish.
Makai straw, roble et gris peuvent être livrés en finition rectifié sur commande.
Makai straw, roble und gris kann in rutschhemmender Ausführung geliefert werden.



23x120
10"x48"

PACKING & SPECIAL PIECES

Ver página 428
See page 428



Rodapié
Skirting

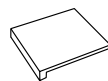

Peldaño
Step

	Pc/Cj	M2/Cj	Cj/PI	M2/PI	Kg/Cj	Kg/PI
23x120	5	1,38	48	66,24	27,5	1349

	Cód.	ADZ
23x120	MP220	MP221



Makai haya 23x120 / 10"x48"

ivory

haya

straw

nogal

roble

gris

madeira



GRUPO
Bia **Recomendable no colocar trabado a mitad de pieza /**
We do not recommend to lay the tiles brickbond
(brick-jointed) halfway

Serie susceptible de tratamiento antideslizante bajo demanda.
Series susceptible to anti-slip treatment on request.
Série sensible au traitement antidérapant sur demande.
Serie mit Antirutschbehandlung auf Anfrage.

Los colores haya y natural se pueden suministrar antideslizante.
Haya and natural colors can be supplied non-slip.
Les couleurs haya et natural peuvent être fournies antidérapantes.
Haya und natural können rutschfest geliefert werden.



25x100
10"x40"

PACKING & SPECIAL PIECES

Ver página 428
See page 428

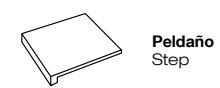

	Pc/Cj	M2/Cj	Cj/PI	M2/PI	Kg/Cj	Kg/PI
25x100	6	1,5	36	54	28,5	1046

	Cód.	ADZ
25x100	MP215	MP216



Madeira natural 20x75 / 8"x30"

nácar

haya

natural

taupe

bosco



GRUPO
Bla **Recomendable no colocar trabado a mitad de pieza /**
We do not recommend to lay the tiles brickbond
(brick-jointed) halfway

Serie susceptible de tratamiento antideslizante bajo demanda.
Series susceptible to anti-slip treatment on request.
Série sensible au traitement antidérapant sur demande.
Serie mit Antirutschbehandlung auf Anfrage.

Los colores crema y gris se pueden suministrar antideslizante.
Crema and gris colors can be supplied non-slip.
Les couleurs crema et gris peuvent être fournies antidérapantes.
Crema und gris können rutschfest geliefert werden.

↓
8,2 mm
↑ 14 faces

20x75
8"x30"

PACKING & SPECIAL PIECES

Ver página 428
See page 428



Rodapié
Skirting

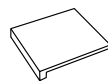

Peldaño
Step

	Pc/Cj	M2/Cj	Cj/PI	M2/PI	Kg/Cj	Kg/PI
20x75	7	1,05	72	75,6	18,5	1352

	Cód.	ADZ
20x75	MP210	MP211



Bosco nogal 20x75 / 8"x30"

blanco

crema

gris

noce

nogal

umbria



GRUPO
Bla **Recomendable no colocar trabado a mitad de pieza /**
We do not recommend to lay the tiles brickbond
(brick-jointed) halfway

Serie susceptible de tratamiento antideslizante bajo demanda.
Series susceptible to anti-slip treatment on request.
Série sensible au traitement antidérapant sur demande.
Serie mit Antirutschbehandlung auf Anfrage.



20x75
8"x30"

PACKING & SPECIAL PIECES

Ver página 428
See page 428



Rodapié
Skirting

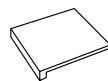

Peldaño
Step

	Pc/Cj	M2/Cj	Cj/PI	M2/PI	Kg/Cj	Kg/PI
20x75	7	1,05	72	75,6	18,5	1352

	Cód.
20x75	MP210



blanco

crema

gris

Umbría crema 20x75 / 8"x30"

willow



GRUPO
Bla  **Recomendable no colocar trabado a mitad de pieza /**
We do not recommend to lay the tiles brickbond
(brick-jointed) halfway

 **Serie susceptible de tratamiento antideslizante bajo demanda.**
Series susceptible to anti-slip treatment on request.
Série sensible au traitement antidérapant sur demande.
Serie mit Antirutschbehandlung auf Anfrage.

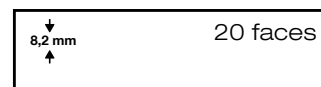

20x75
8"x30"

PACKING & SPECIAL PIECES

 **Ver página 428**
See page 428



Rodapié
Skirting

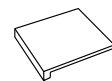

Peldaño
Step

	Pc/Cj	M2/Cj	Cj/PI	M2/PI	Kg/Cj	Kg/PI
20x75	7	1,05	72	75,6	18,5	1352

	Cód.	ADZ
20x75	MP210	MP211



perla

ceniza

haya

taupe

natural

Willow natural 20x75 / 8"x30"

ES

Pensando en facilitar las obras, sobretodo las reformas, se crea Xtra, un porcelánico que mantiene las mismas características técnicas pero con un grueso que es factible colocar encima de otros materiales ya colocados.

EN

Thinking about facilitating the works, especially the renovations, Xtra was created, a porcelain tile that maintains the same technical characteristics but with a thickness that can be placed on top of other materials already placed.

FR

En pensant faciliter les travaux, notamment les rénovations, a été créé Xtra, un grès cérame qui conserve les mêmes caractéristiques techniques mais avec une épaisseur qui peut être posée sur d'autres matériaux déjà posés.

DE

Mit dem Gedanken, die Arbeiten, insbesondere die Renovierungen, zu erleichtern, wurde Xtra geschaffen, eine Feinsteinzeugfliese, die die gleichen technischen Eigenschaften beibehält, aber eine Dicke aufweist, die auf anderen bereits verlegten Materialien verlegt werden kann.



XTRA

ARTY • CONVEC • CEDAR • TABIL

Presentamos nuestra nueva familia de porcelánico **XTRA /** extra **slim**, extra **resistente**, extra **flexible** y, sobre todo, extra **sostenible**.



¿Por qué extra slim? Su espesor oscila entre los 6 mm. Esto la hace menos pesada y mejora su manejabilidad. Además, su espesor permite que se pueda aplicar en más campos a la hora de decorar y revestir proyectos.



¿Por qué extra flexible? Es una pieza más fina y, por tanto, más elástica. Esto, junto a su poco peso, facilita la instalación. Convexidad y planitud.



¿Por qué extra resistente? Destacamos su resistencia a la carga de rotura. Estas piezas están diseñadas y producidas con unas prensas especiales y tierras de vidrio evitando considerablemente roturas en las piezas.



¿Por qué extra sostenible? Al tener un espesor tan fino podemos transportar más metros cuadrados en un mismo pallet. Esto abarata la logística y transporte, colaborando directamente con el respeto al medio ambiente mientras reducimos las emisiones de CO2 y residuos. Además, utilizamos menos materia prima y, por tanto, se necesita menos energía para producir estas piezas. Con esta nueva tipología de producto ahorraremos una gran cantidad de plástico, madera y CO2.



¿Por qué extra versátil? Su reducido espesor permite mucha más versatilidad que cualquier otra pieza de espesor tradicional, tanto en la fabricación como en el transporte. El reducido peso facilita que las cajas puedan contener más piezas y por lo tanto más m2/cj.



¿Por qué extra ligero? Su volumen es inferior a cualquier otra pieza, por lo que su peso se reduce considerablemente. Ello facilita muchos aspectos, como es el caso de la colocación en formatos más grandes.

We present our new family of **XTRA** porcelain tiles: extra **slim**, extra **resistant**, extra **flexible** and, above all, extra **sustainable**.



Why extra slim? Its thickness varies between 6 mm. This makes it less heavy and improves its handling. In addition, its thickness allows it to be applied in a wider variety of spaces when it comes to decorating and coating projects.



Why extra flexible? It is a thinner piece and, therefore, more elastic. This, together with its low weight, facilitates installation. Convexity and flatness.



Why extra resistant? We highlight its resistance to breaking load. These pieces are designed and produced with special presses and glass clays, considerably avoiding breakages in the pieces.



Why extra ecologic? By having such a thin thickness, we can transport more square meters on the same pallet. This makes logistics and transport cheaper, collaborating directly with respect for the environment while reducing CO2 emissions and waste. In addition, we use less raw material and therefore less energy is needed to produce these parts. With this new type of product we will save a large amount of plastic, wood and CO2.



Why extra versatile? Its reduced thickness allows much more versatility than any other piece of traditional thickness, both in manufacturing and in transport. The reduced weight makes it easier for the boxes to contain more pieces and therefore more sqm/ctn.



Why extra light? Its volume is less than any other piece, so its weight is considerably reduced. This facilitates many aspects, such as placement in larger formats.

convec



Convec dark 60x120 / 24"x48"

convec



↓
6,8 mm
↑
10 faces
60x120
24"x48"



Serie susceptible de tratamiento antideslizante bajo demanda.
 Series susceptible to anti-slip treatment on request.
 Série sensible au traitement antidérapant sur demande.
 Serie mit Antirutschbehandlung auf Anfrage.

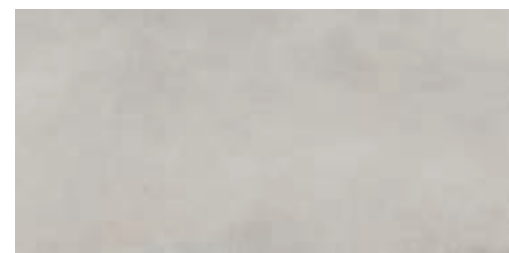

convec light



convec medium

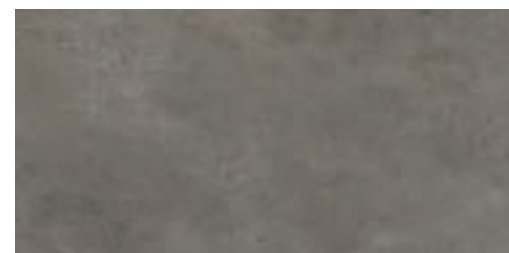

convec dark

PACKING & SPECIAL PIECES

	Pc/Cj	M2/Cj	Cj/Pl	M2/Pl	Kg/Cj	Kg/Pl	Cód.
60x120	3	2,16	38,8	69,12	108	1067,6	60x120 MP420

Ver página 428
See page 428

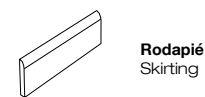

Rodapié
Skirting

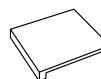

Peldaño
Step

Convec light 60x120 / 24"x48"



arty



Arty greige 60x120 / 24"x48"

arty



xtra

↓
6,8 mm
↑

10 faces

60x120
24"x48"



Serie susceptible de tratamiento antideslizante bajo demanda.
 Series susceptible to anti-slip treatment on request.
 Série sensible au traitement antidérapant sur demande.
 Serie mit Antirutschbehandlung auf Anfrage.

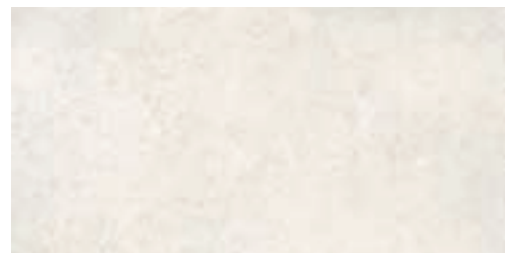

arty bone

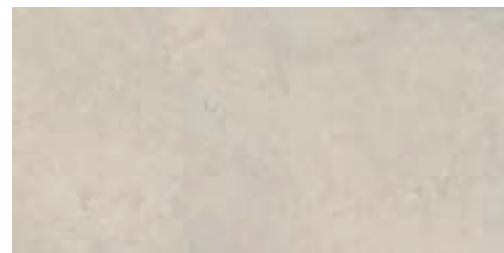

arty greige

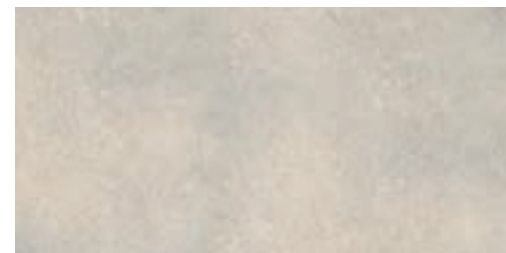

arty grey

PACKING & SPECIAL PIECES

	Pc/Cj	M2/Cj	Cj/Pl	M2/Pl	Kg/Cj	Kg/Pl
60x120	3	2,16	32	69,12	37	1213

	Cód.
60x120	MP420

 **Ver página 428**
See page 428

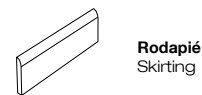

Rodapié
Skirting



Peldaño
Step

Arty grey 60x120 / 24"x48"



cedar

Cedar grey 20x120 / 8"x48"

cedar



GRUPO Bla
Recomendable no colocar trabado a mitad de pieza / We do not recommend to lay the tiles brickbond (brick-jointed) halfway

20x120
 8"x48"

24 faces
 ↓ 6,8 mm
 ↑



Serie susceptible de tratamiento antideslizante bajo demanda.
 Series susceptible to anti-slip treatment on request.
 Série sensible au traitement antidérapant sur demande.
 Serie mit Antirutschbehandlung auf Anfrage.



cedar light grey



cedar natural



cedar medium

PACKING & SPECIAL PIECES

	Pc/Cj	M2/Cj	Cj/Pl	M2/Pl	Kg/Cj	Kg/Pl
20x120	9	2,16	44	95,04	32	1437

	Cód.
20x120	MP400

Ver página 428
 See page 428

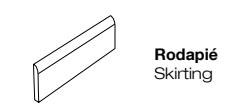

Cedar natural 20x120 / 8"x48"



tabil



Tabil dark 20x120 / 8"x48"

tabil



GRUPO
Bla



Recomendable no colocar trabado a mitad de pieza / We do not recommend to lay the tiles brickbond (brick-jointed) halfway

20x120
8"x48"

24 faces
6,8 mm



Serie susceptible de tratamiento antideslizante bajo demanda.
Series susceptible to anti-slip treatment on request.
Série sensible au traitement antidérapant sur demande.
Serie mit Antirutschbehandlung auf Anfrage.



tabil light



tabil natural



tabil dark

PACKING & SPECIAL PIECES

	Pc/Cj	M2/Cj	Cj/Pl	M2/Pl	Kg/Cj	Kg/Pl
20x120	9	2,16	44	95,04	32	1437

	Cód.
20x120	MP400

Ver página 428
See page 428

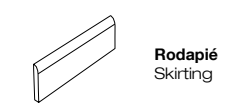

Rodapié
Skirting



Peldaño
Step

Tabil natural 20x120 / 8"x48"



ES

Bien sea en mate o en brillo, o incluso en adz, es un producto de mucha resistencia y con acabados muy logrados.

EN

Whether in matt or gloss, or even in adz, it is a highly resistant product with very successful finishes.

FR

Qu'il soit en mat ou brillant, voire même en adz, c'est un produit très résistant aux finitions très réussies.

DE

Ob in Matt oder Glanz oder sogar in Adz, es ist ein äußerst widerstandsfähiges Produkt mit sehr gelungenen Oberflächen.

GP

GLAZED PORCELAIN

AMYR • SAFEER • MATT COLLECTION • GLOSSY COLLECTION
BERLIN • DC TINSEL • VEROY • RANGE ADZ • DYLON
BELLAGIO • BELLAGIO GOLD • GARI • GREECE • JAYA MATT
MUTAZ • RACER • RENO • BYRONBAY • SERENE • STYL
TOWNS • NATURE • STATUS • THARIS • RAFAELLO • SHEA
BELGRAVIA • MANHATTAN

manhattan



Revestimiento / Decorado de la serie.
Wall tile / Deco from the series.
Enrobage / Décoré de la série.
Wandfliesen / Dekoriert aus der Serie. P805

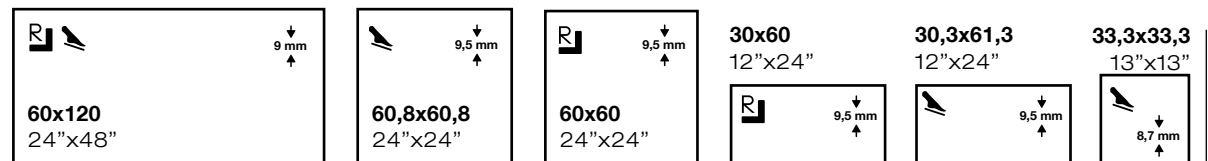

Formato únicamente disponible en ADZ en los colores Pearl, Tan y Grey.

Serie susceptible de tratamiento antideslizante bajo demanda.
Series susceptible to anti-slip treatment on request.
Série sensible au traitement antidérapant sur demande.
Serie mit Antirutschbehandlung auf Anfrage.

REVESTIMIENTO COORDINADO
coordinated wall tile
MANHATTAN 30X90 cm
Pág. 316

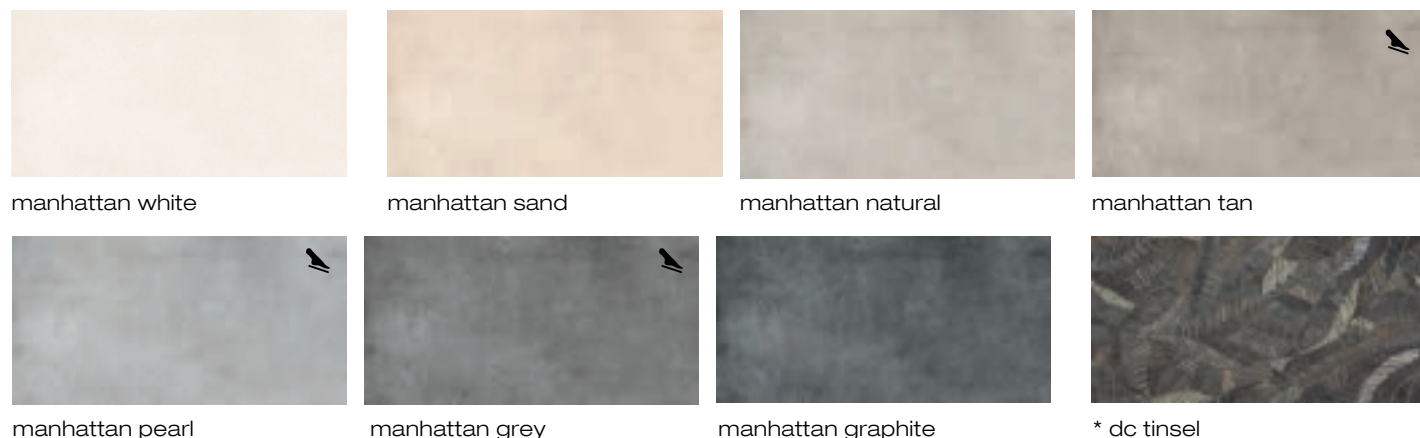

PACKING & SPECIAL PIECES

	Pc/Cj	M2/Cj	Cj/PI	M2/PI	Kg/Cj	Kg/PI
30x60	6	1,08	48	51,84	23,6	1152,8
30,3x61,3	7	1,3	40	52	25	1020
33x33	12	1,33	46	61,18	24,5	1147
60x60	4	1,44	30	43,2	31,4	962
60,8x60,8	4	1,48	30	44,4	31,35	960,5
60x120	2	1,44	36	51,84	29,5	1091

	Cód.	Rect.	ADZ
30x60	-	MP120	-
30,3x61,3	MP110	-	MP116
33x33	-	-	MP105
60x60	-	MP170	-
60,8x60,8	MP160	-	MP165
60x120	-	MP180	MP185

Ver página 428
See page 428



Rodapié
Skirting

Peldaño
Step

Manhattan tan 60x120 / 24" x48"



serene

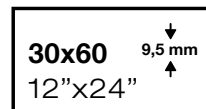
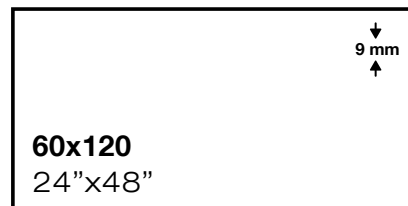
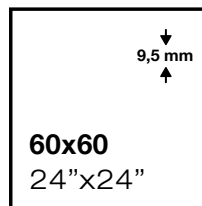

Serie susceptible de tratamiento antideslizante bajo demanda.
Series susceptible to anti-slip treatment on request.
Série sensible au traitement antidérapant sur demande.
Serie mit Antirutschbehandlung auf Anfrage.

REVESTIMIENTO COORDINADO
coordinated wall tile
SERENE 30X90 cm
Pág. 318

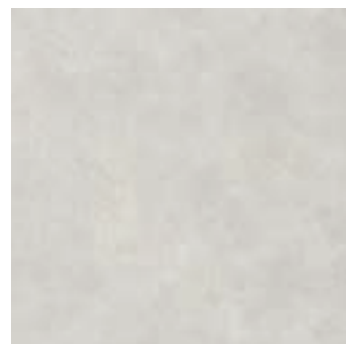

serene perla



serene gris

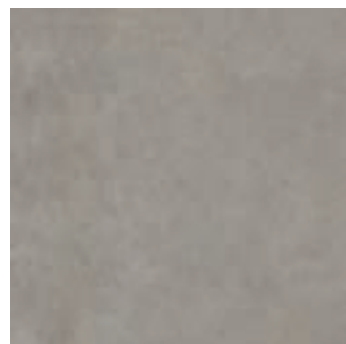

serene grafito

PACKING & SPECIAL PIECES

	Pc/Cj	M2/Cj	Cj/PI	M2/PI	Kg/Cj	Kg/PI	Rect.
30x60	6	1,08	48	51,84	23,6	1152,8	30x60 MP120
60x60	4	1,44	30	43,2	31,4	962	60x60 MP170
60x120	2	1,44	36	51,84	29,5	1091	60x120 MP180

 Ver página 428
See page 428



Rodapié
Skirting

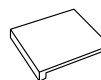

Peldaño
Step

Serene grafito 60x60 / 24"x24"



veroy

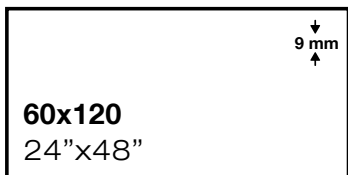

* Serie compuesta únicamente por 2 piezas con posición A y B.
 Series composed only of 2 pieces with position A and B.
 Série composée uniquement de 2 pièces avec position A et B.
 Serie bestehend aus nur 2 Stück mit Position A und B.

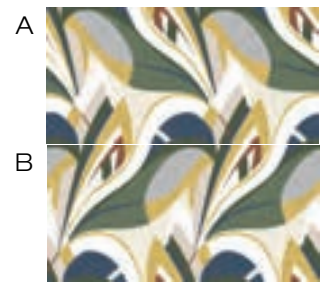

*dc evia

Ver página 428
See page 428



Rodapié
Skirting

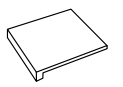

Peldaño
Step

PACKING & SPECIAL PIECES

	Pc/Cj	M2/Cj	Cj/Pl	M2/Pl	Kg/Cj	Kg/Pl
60x120	2	1,44	36	51,84	29,5	1091

	Rect.
Veroy	MP189
Tex Veroy	MP195
Line Veroy	MP195
Dc Evia	P810

Veroy ocre 60x120 / 24"x48" _ Dc Evia 60x120 / 24"x48" _ Veroy hueso 60x120 / 24"x48"

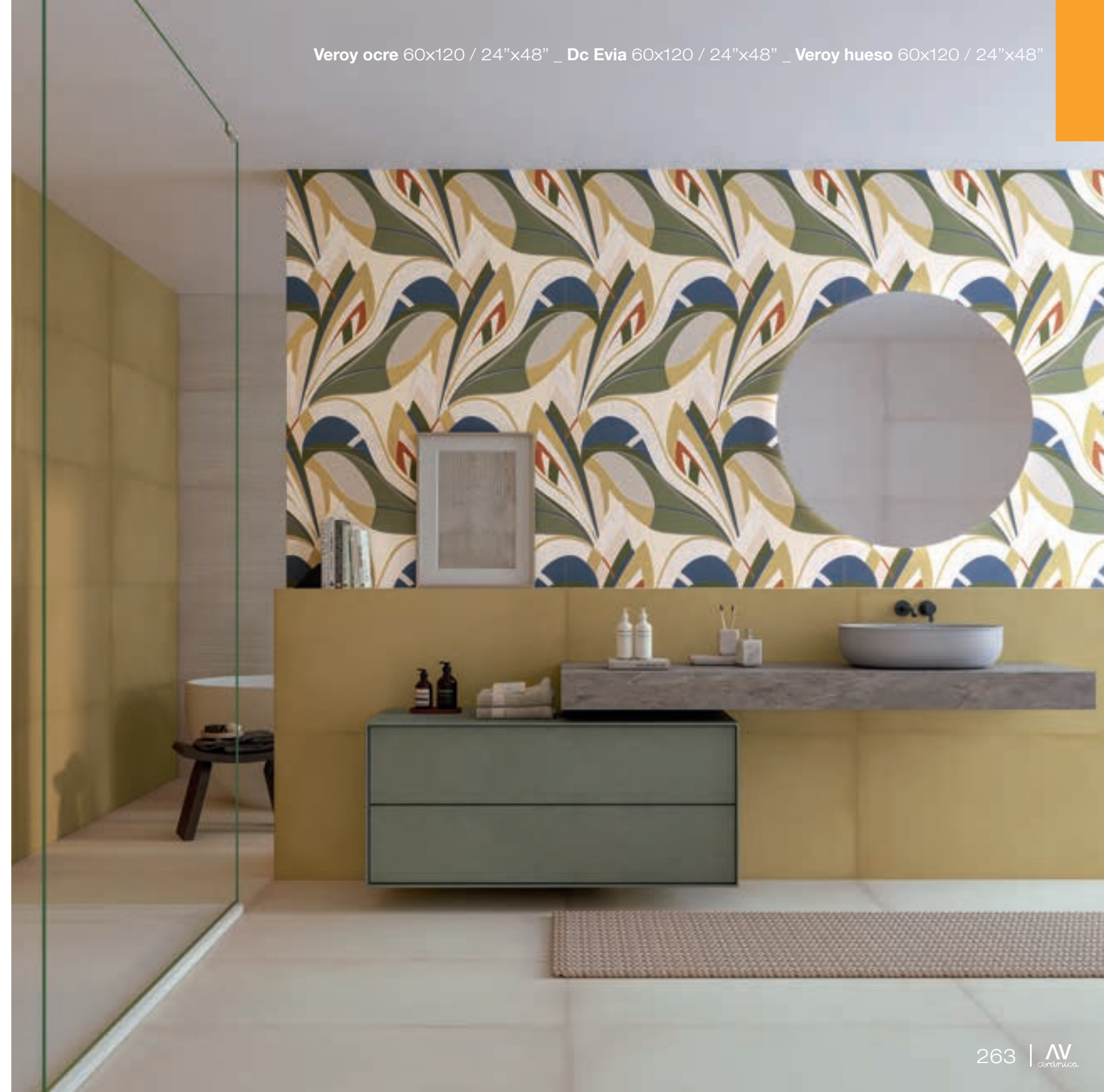

styl

PO 

Interior y Exterior /
Indoor and Outdoor / **in&out**

9,5 mm

60,8x60,8
24"x24"

9 mm

30,3x61,3
12"x25"

30x30 MP187



Mosaicos
Mosaics
Mosaïques
Mosaik

30,3x61,3 12"x25"



rlv elyt blanco rlv elyt arena rlv elyt perla rlv elyt silver

30,3x61,3 12"x25" / **60,8x60,8** 24"x24"



styl blanco styl arena styl perla styl silver

PACKING & SPECIAL PIECES

	Pc/Cj	M2/Cj	Cj/Pl	M2/Pl	Kg/Cj	Kg/Pl
30,3x61,3	7	1,3	40	52	25	1020
60,8x60,8	4	1,48	30	44,4	31,35	960,5

	Cód.
30,3x61,3	MP116
60,8x60,8	MP165
Rlv Elyt	MP115

 **Ver página 428**
See page 428

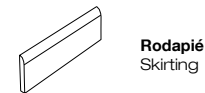

Rodapié
Skirting

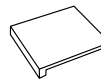

Peldaño
Step

Styl arena _ Rlv elyt arena 30,3x61,3 / 12"x25" _ Styl arena 60,8x60,8 / 24"x24"



berlín



Berlín gris 45x45 / 18"x18"

PACKING & SPECIAL PIECES

	Pc/Cj	M2/Cj	Cj/PI	M2/PI	Kg/Cj	Kg/PI
30,3x61,3	7	1,3	40	52	25	1020
45x45	6	1,22	52	63,44	25,8	1361,6
60,8x60,8	4	1,48	30	44,4	31,35	960,5
75x75	3	1,69	30	50,7	41,2	1256

	Cód.	Rect.
30,3x61,3	MP110	-
45x45	MP132	-
60,8x60,8	MP160	-
75x75	-	MP190

Ver página 428
See page 428



Rodapié
Skirting

Peldaño
Step



babylon / dylon

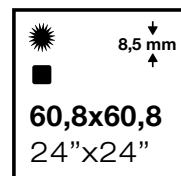
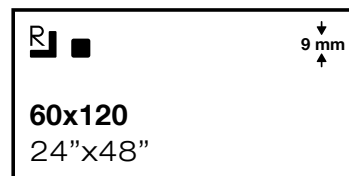
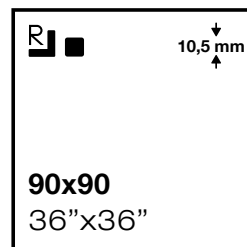

marfil



taupe

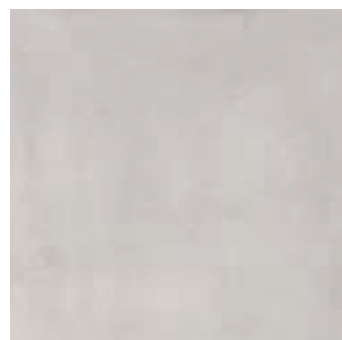

perla



gris

PACKING & SPECIAL PIECES

	Pc/Cj	M2/Cj	Cj/PI	M2/PI	Kg/Cj	Kg/PI
60,8x60,8	5	1,85	30	55,5	34	1040
90x90	2	1,62	27	43,74	40	1100
60x120	2	1,44	36	51,84	29,5	1091

	Matt	Rect. Matt	Gloss
60,8x60,8	MP140	-	MP141
90x90	-	MP201	-
60x120	-	MP180	-

Ver página 428
See page 428

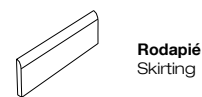

Rodapié
Skirting

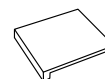

Peldaño
Step

Dylon taupe 60x120 / 24"x48"



tharis

PO

 R
 CMYK
 V2
 GRUPO Bla
 PTV+36

60x120 24"x48" ↓ 9 mm ↑	60x60 24"x24" ↓ 9,5 mm ↑	30x60 12"x24" pearl taupe ↓ 9,5 mm ↑
----------------------------------	-----------------------------------	---



tharis pearl

tharis taupe

tharis grey

Tharis grey 60x120 / 24"x48"

PACKING & SPECIAL PIECES

	Pc/Cj	M2/Cj	Cj/PI	M2/PI	Kg/Cj	Kg/PI	
30x60	6	1,08	48	51,84	23,6	1152,8	Rect.
60x60	4	1,44	30	43,2	31,4	962	30x60 MP120
60x120	2	1,44	36	51,84	29,5	1091	60x60 MP170
							60x120 MP180

Ver página 428
See page 428



Rodapié
Skirting

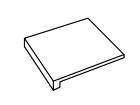

Peldaño
Step

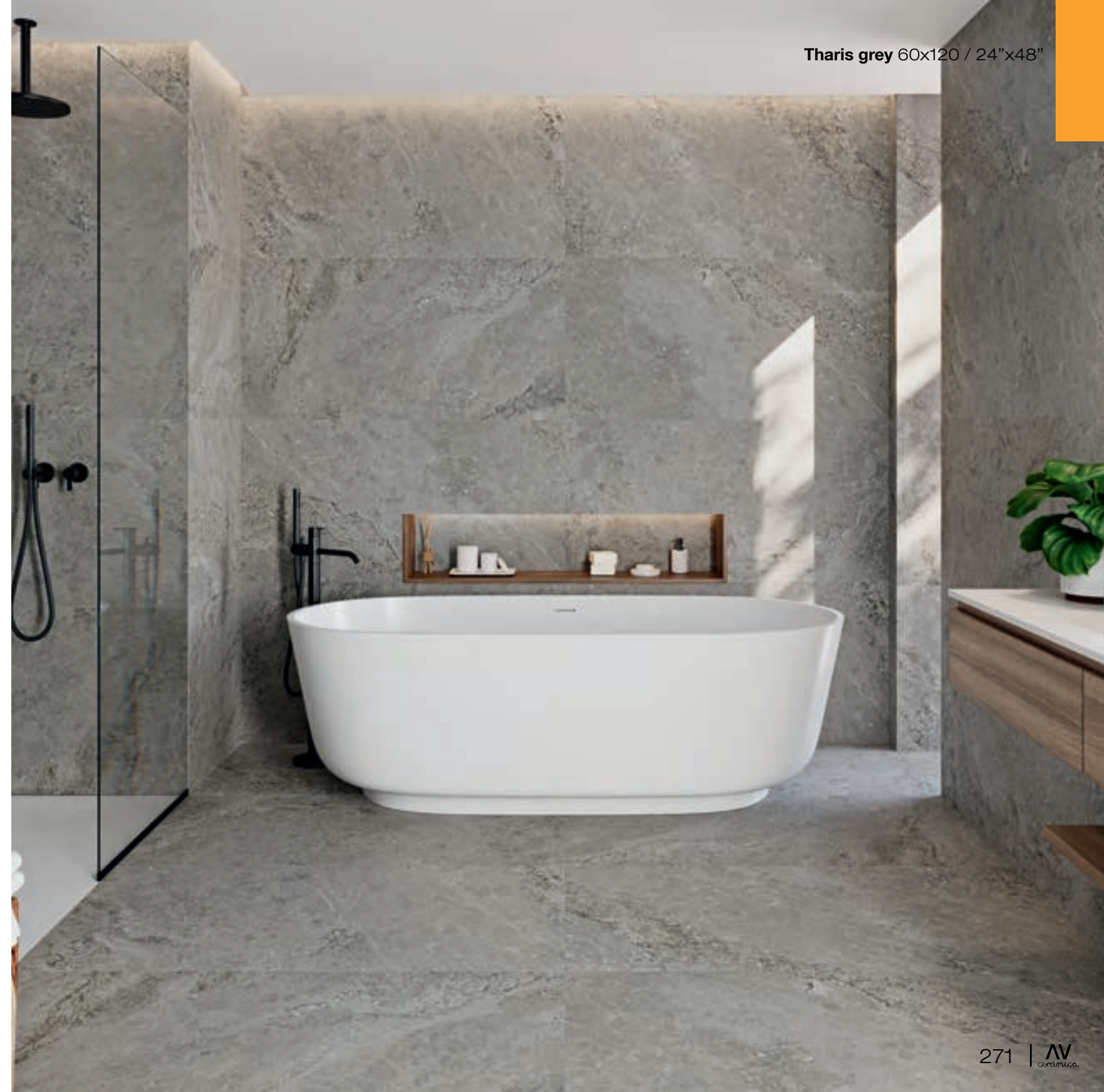

nature

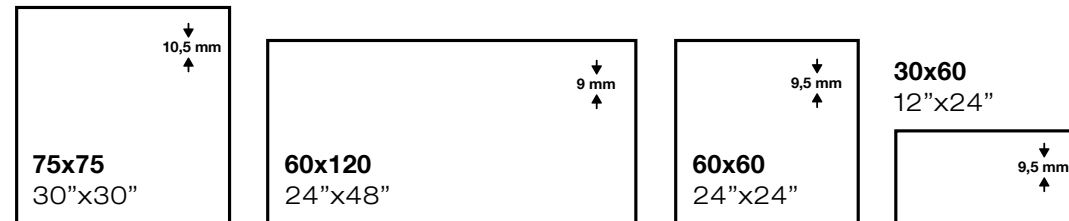

Serie susceptible de tratamiento antideslizante bajo demanda.
Series susceptible to anti-slip treatment on request.
Série sensible au traitement antidérapant sur demande.
Serie mit Antirutschbehandlung auf Anfrage.

REVESTIMIENTO COORDINADO
coordinated wall tile
NATURE 30X90 cm
Pág. 336

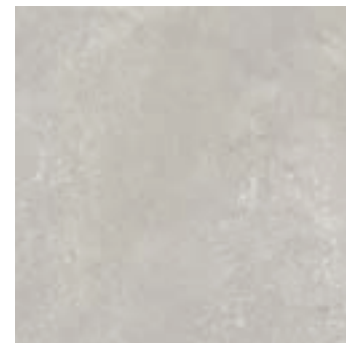

nature perla

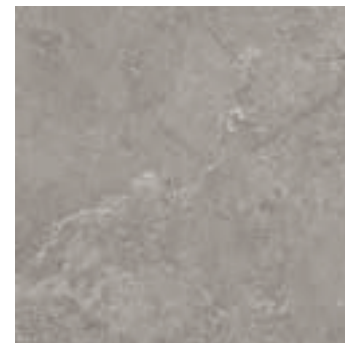

nature gris

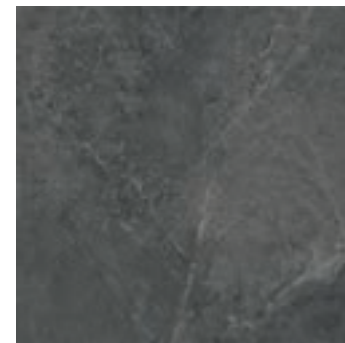

nature grafito

PACKING & SPECIAL PIECES

	Pc/Cj	M2/Cj	Cj/PI	M2/PI	Kg/Cj	Kg/PI
30x60	6	1,08	48	51,84	23,6	1152,8
60x60	4	1,44	30	43,2	31,4	962
75x75	3	1,69	30	50,7	41,2	1256
60x120	2	1,44	36	51,84	29,5	1091

	Rect.
30x60	MP120
60x60	MP170
75x75	MP190
60x120	MP180

Ver página 428
See page 428



Rodapié
Skirting

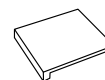

Peldaño
Step

Nature perla 60x60 / 24"x24"



status

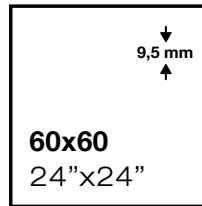

Serie susceptible de tratamiento antideslizante bajo demanda.
 Series susceptible to anti-slip treatment on request.
 Série sensible au traitement antidérapant sur demande.
 Serie mit Antirutschbehandlung auf Anfrage.

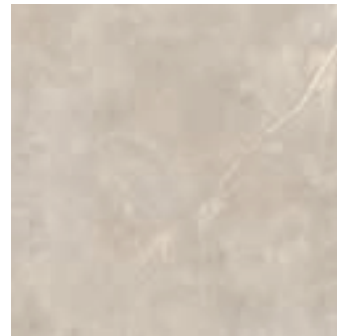

status beige

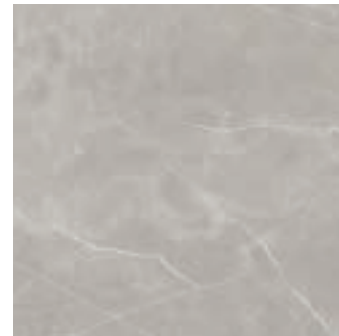

status perla

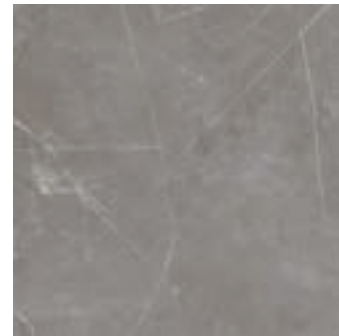

status gris

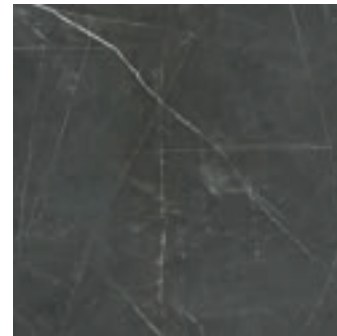

status grafito

PACKING & SPECIAL PIECES

	Pc/Cj	M2/Cj	Cj/Pl	M2/Pl	Kg/Cj	Kg/Pl
60x60	4	1,44	30	43,2	31,4	962
60x120	2	1,44	36	51,84	29,5	1091

	Rect.
60x60	MP170
60x120	MP180

 **Ver página 428**
See page 428



Rodapié
Skirting

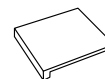

Peldaño
Step

Status grafito 60x60 / 24"x24"



belgravia

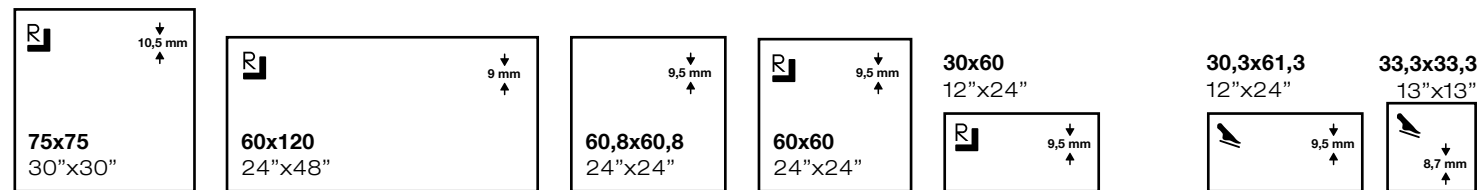

Serie susceptible de tratamiento antideslizante bajo demanda.
 Series susceptible to anti-slip treatment on request.
 Série sensible au traitement antidérapant sur demande.
 Serie mit Antirutschbehandlung auf Anfrage.

Formatos únicamente disponibles en ADZ en los colores Pearl, Beige y Grey



belgravia beige belgravia pearl belgravia grey belgravia anthracite

PACKING & SPECIAL PIECES

	Pc/Cj	M2/Cj	Cj/PI	M2/PI	Kg/Cj	Kg/PI
30x60	6	1,08	48	51,84	23,6	1152,8
30,3x61,3	7	1,3	40	52	25	1020
33x33	12	1,33	46	61,18	24,5	1147
60x60	4	1,44	30	43,2	31,4	962
60,8x60,8	4	1,48	30	44,4	31,35	960,5
75x75	3	1,69	30	50,7	41,2	1256
60x120	2	1,44	36	51,84	29,5	1091

	Cód.	ADZ
30x60	MP120	-
30,3x61,3	MP110	MP116
33x33	-	MP105
60x60	MP170	-
60,8x60,8	MP160	-
75x75	MP190	-
60x120	MP180	-

Ver página 428
See page 428

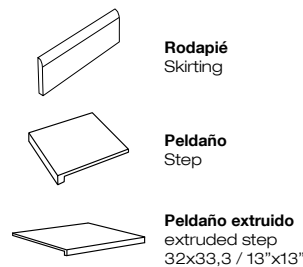

Belgravia beige 60x120 / 24"x48"



jaya matt

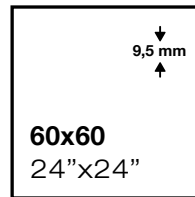
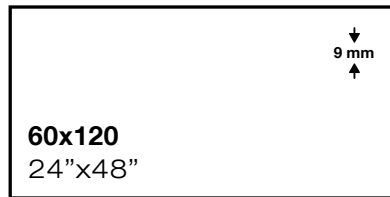

jaya matt beige

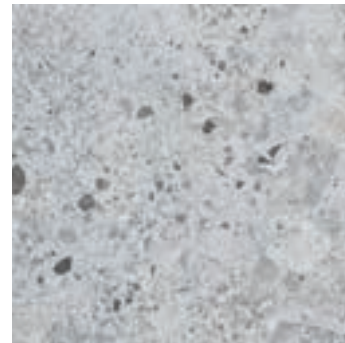

jaya matt gris

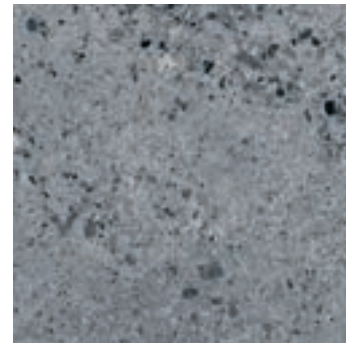

jaya matt grafito

PACKING & SPECIAL PIECES

	Pc/Cj	M2/Cj	Cj/PI	M2/PI	Kg/Cj	Kg/PI
60x60	4	1,44	30	43,2	31,4	962
60x120	2	1,44	36	51,84	29,5	1082

	Cód.
60x60	MP170
60x120	MP180

Ver página 428
See page 428



Rodapié
Skirting

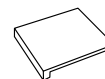

Peldaño
Step

Jaya crema 60x120 / 24"x48" _ Byronbay taupe 60x60 / 24"x24"



byronbay

PO

 R
 CMYK
 V2
 GRUPO Bla
 PTV+36

60x120
24"x48"
9 mm

60x60
24"x24"
9,5 mm

30x60
12"x24"
9,5 mm



byronbay almond



byronbay taupe



byronbay grey

PACKING & SPECIAL PIECES

	Pc/Cj	M2/Cj	Cj/PI	M2/PI	Kg/Cj	Kg/PI
30x60	6	1,08	48	51,84	23,6	1152,8
60x60	4	1,44	30	43,2	31,4	962
60x120	2	1,44	36	51,84	29,5	1091

	Rect.
30x60	MP125
60x60	MP173
60x120	MP185

Ver página 428
See page 428



Rodapié
Skirting

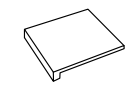

Peldaño
Step

Byronbay grey 60x120 / 24"x48" _ Cima blanco 13x15 / 5"x6"



towns

Interior y Exterior /
Indoor and Outdoor / **in&out**

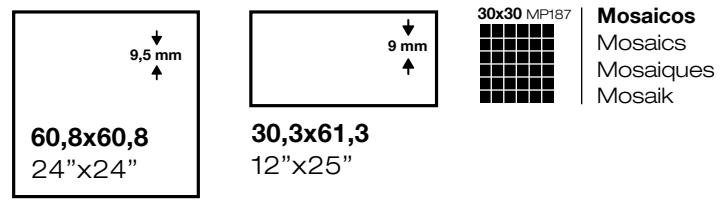

Mosaicos
Mosaics
Mosaïques
Mosaik

30,3x61,3 12"x25"

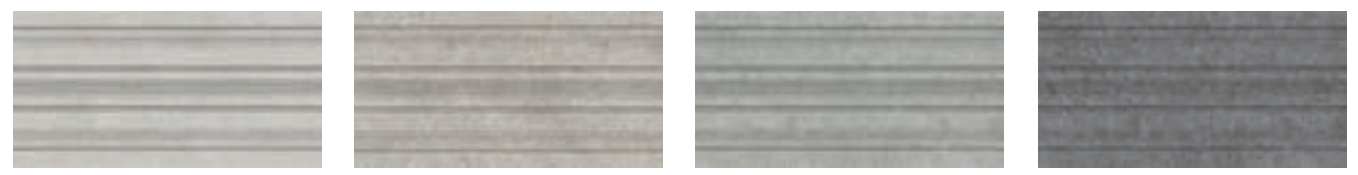

rlv nimes white rlv nimes taupe rlv nimes pearl rlv nimes gris

30,3x61,3 12"x25" / **60,8x60,8** 24"x24"

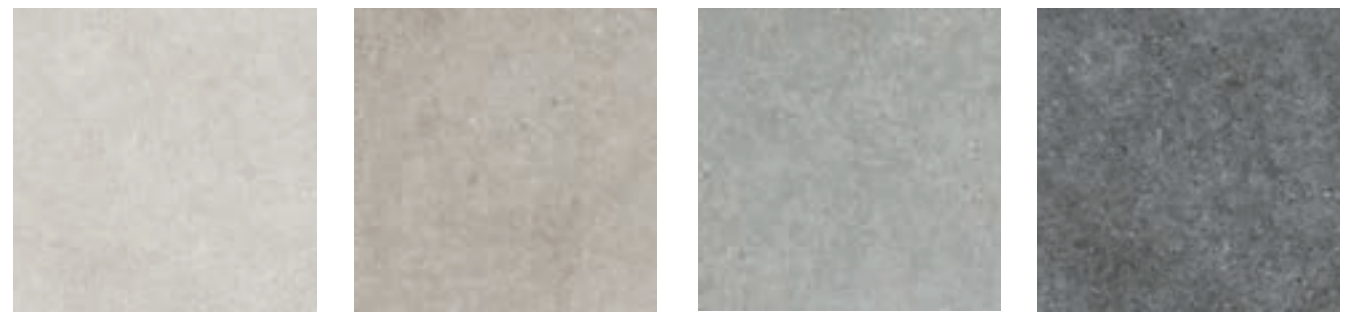

towns white towns taupe towns pearl towns gris

PACKING & SPECIAL PIECES

	Pc/Cj	M2/Cj	Cj/Pl	M2/Pl	Kg/Cj	Kg/Pl
30,3x61,3	7	1,3	40	52	25	1020
60,8x60,8	4	1,48	30	44,4	31,35	960,5

	Cód.
30,3x61,3	MP116
60,8x60,8	MP165
Rlv Nimes	MP115

Ver página 428
See page 428



Rodapié
Skirting

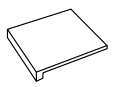

Peldaño
Step

Towns gris / Rlv nimes gris 30,3x61,3 / 12"x25" _ Towns gris 60,8x60,8 / 24"x24"



mutaz

Interior y Exterior /
Indoor and Outdoor /

in & out

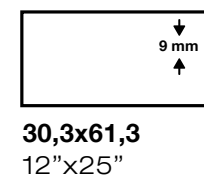
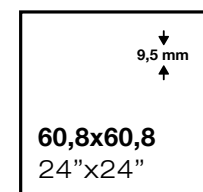

Mosaicos
Mosaics
Mosaïques
Mosaik



mutaz blanco



mutaz crema

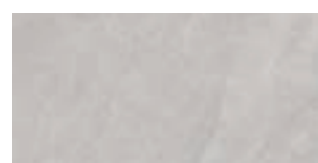

mutaz gris

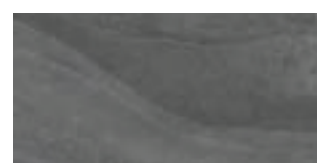

mutaz marengo

30,3x61,3 12"x25" / 60,8x60,8 24"x24"

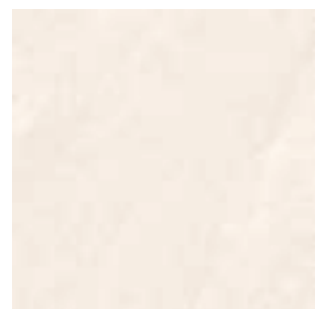

mutaz blanco



mutaz crema

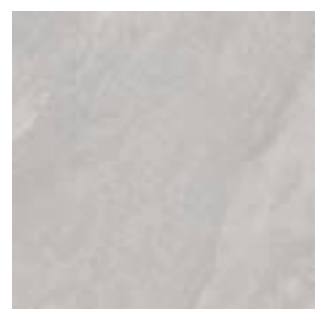

mutaz gris

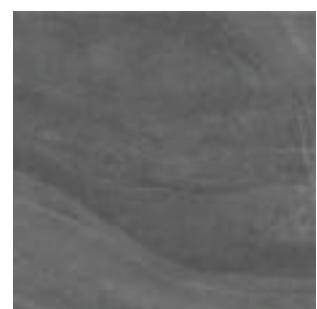

mutaz marengo

PACKING & SPECIAL PIECES

	Pc/Cj	M2/Cj	Cj/Pl	M2/Pl	Kg/Cj	Kg/Pl
30,3x61,3	7	1,3	40	52	25	1020
60,8x60,8	4	1,48	30	44,4	31,35	960,5

	Cód.
30,3x61,3	MP116
60,8x60,8	MP165

Ver página 428
See page 428



Rodapié
Skirting

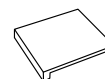

Peldaño
Step

Mutaz marengo 60,8x60,8 / 24"x24"



range adz

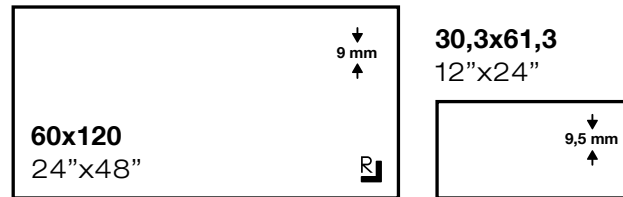

Range adz almond 30,3x61,3 / 12"x24"

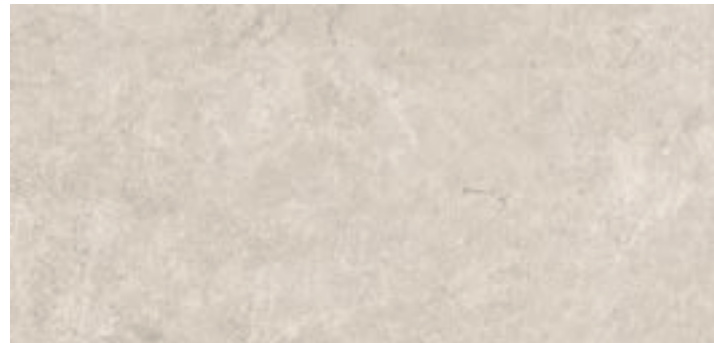

range adz almond



range adz beige



PACKING & SPECIAL PIECES

	Pc/Cj	M2/Cj	Cj/PI	M2/PI	Kg/Cj	Kg/PI
30,3x61,3	7	1,3	40	52	25	1020
60x120	2	1,44	36	51,84	29,5	1091

	Cód.
30,3x61,3	MP116
60x120	MP185

Ver página 428
See page 428

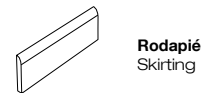

Rodapié
Skirting

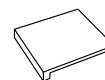

Peldaño
Step

amyr

 PO
 
 CMYK
  V2
  CLASE 3
  GRUPO Bla

Interior y Exterior /
Indoor and Outdoor / **in&out**

Amyr musgo 60,8x60,8 / 24"x24"

↓
 9,5 mm
 ↑
60,8x60,8
 24"x24"

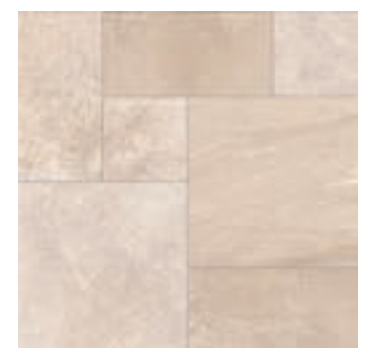

ivory

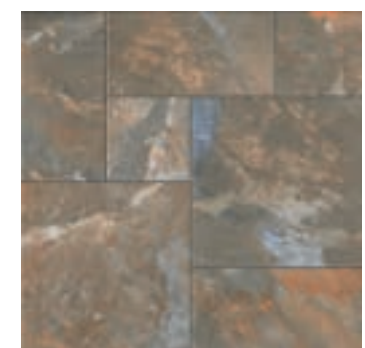

musgo



antracita

PACKING & SPECIAL PIECES

	Pc/Cj	M2/Cj	Cj/Pl	M2/Pl	Kg/Cj	Kg/Pl	Cód.
60,8x60,8	4	1,48	30	44,4	31,35	960,5	60,8x60,8 MP165

 **Ver página 428**
See page 428



safeer



blanco

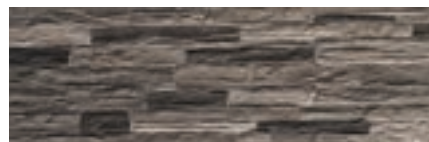

dark

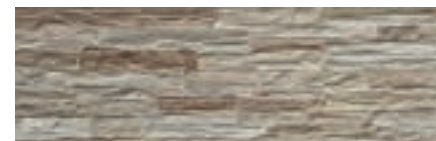

arena

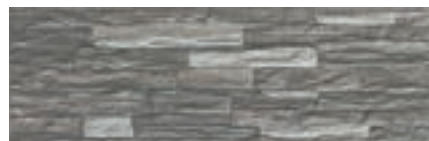

gris

PACKING & SPECIAL PIECES

	Pc/Cj	M2/Cj	Cj/Pl	M2/Pl	Kg/Cj	Kg/Pl		Cód.
17x52	17	1,5	55	82,5	22,3	1246,5	17x52	MP100

Safeer blanco 17x52 / 7"x21"



bellagio / bellagio gold



60x120
24"x48"

9 mm

60x60
24"x24"

9,5 mm

60,8x60,8
24"x24"

8,5 mm

REVESTIMIENTO COORDINADO

coordinated wall tile

BELLAGIO 30X90 cm

Pág. 344



bellagio

PACKING & SPECIAL PIECES

	Pc/Cj	M2/Cj	Cj/PI	M2/PI	Kg/Cj	Kg/PI
60,8x60,8	5	1,85	30	55,5	34	1040
60x60	4	1,44	30	43,2	31,4	962
60x120	2	1,44	36	51,84	29,5	1091

	Matt	Rect. Matt	Gloss	Rect. Gloss
60,8x60,8	-	-	MP141	-
60x60	MP170	-	-	-
60x120	-	MP180	-	MP181

Ver página 428
See page 428



Rodapié
Skirting

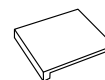

Peldaño
Step

Bellagio 60x120 / 24"x48"



greece



Greece blanco 60,8x60,8 / 24"x24"

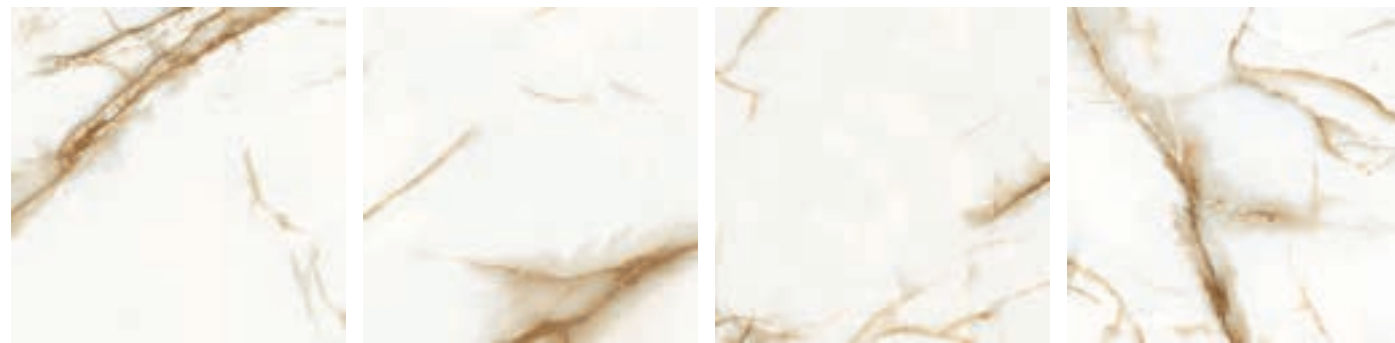
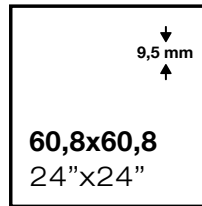

greece blanco



PACKING & SPECIAL PIECES

	Pc/Cj	M2/Cj	Cj/Pl	M2/Pl	Kg/Cj	Kg/Pl
60,8x60,8	4	1,48	30	44,4	31,35	960,5
60x120	2	1,44	36	51,84	29,5	1091

	Cód.	Rect.
60,8x60,8	MP161	-
60x120	-	MP181

Ver página 428
See page 428

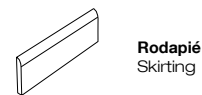

Rodapié
Skirting

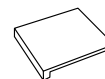

Peldaño
Step

rafaello / shea



Rafaello 60x120 / 24"x48"

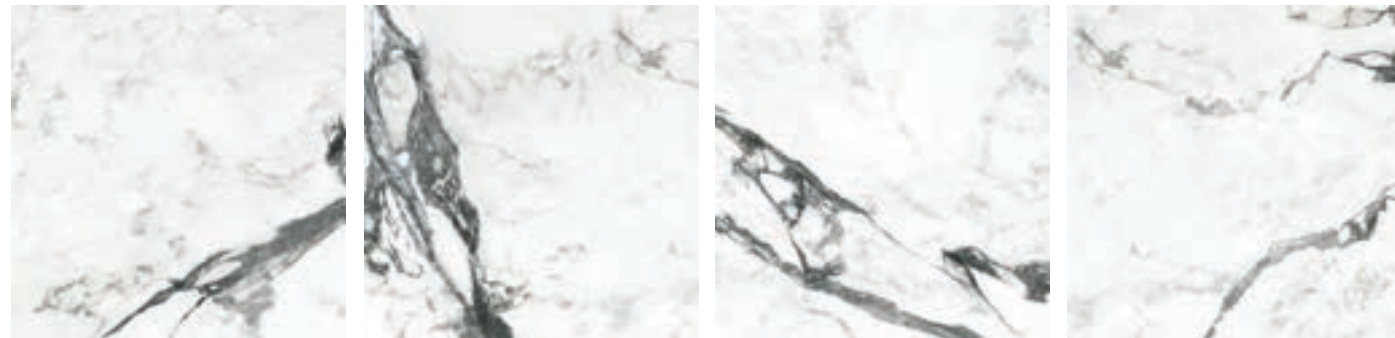
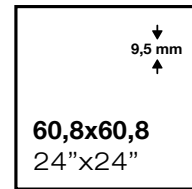
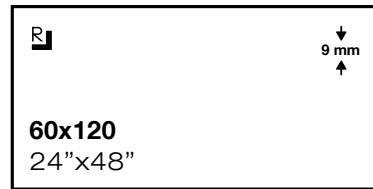

rafaello



PACKING & SPECIAL PIECES

	Pc/Cj	M2/Cj	Cj/Pl	M2/Pl	Kg/Cj	Kg/Pl
60,8x60,8	5	1,85	30	55,5	34	1040
60x120	2	1,44	36	51,84	29,5	1091

	Gloss	Rect. Gloss	Matt	Rect. Matt
60,8x60,8	MP161	-	MP160	-
60x120	-	MP181	-	MP180

Ver página 428
See page 428

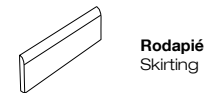

Rodapié
Skirting

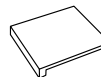

Peldaño
Step

gari



↓
9,5 mm
↑

60,8x60,8
24"x24"

↓
9 mm
↑

60x120
24"x48"

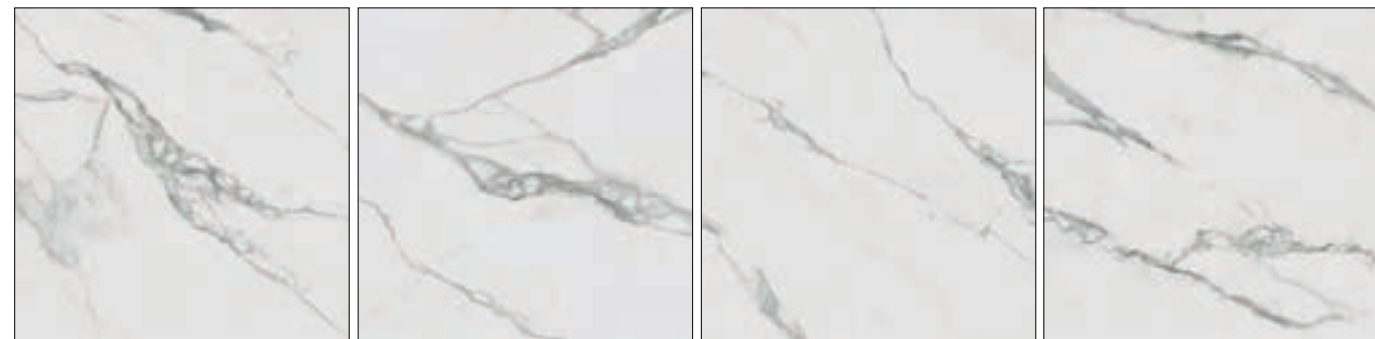

gari blanco

Gari blanco 60x120 / 24"x48"



PACKING & SPECIAL PIECES

	Pc/Cj	M2/Cj	Cj/Pl	M2/Pl	Kg/Cj	Kg/Pl
60,8x60,8	4	1,48	30	44,4	31,35	960,5
60x120	2	1,44	36	51,84	29,5	1091

	Cód.	Rect.
60,8x60,8	MP161	-
60x120	-	MP181

Ver página 428
See page 428



Rodapié
Skirting

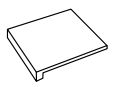

Peldaño
Step

racer / reno

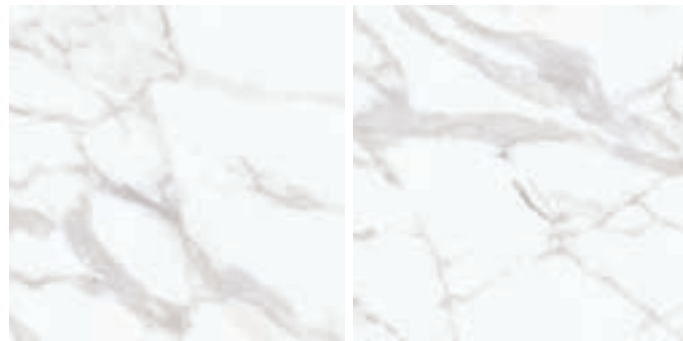
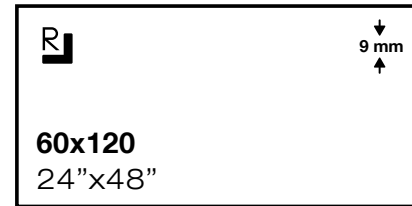
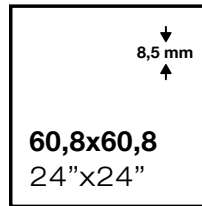

racer blanco

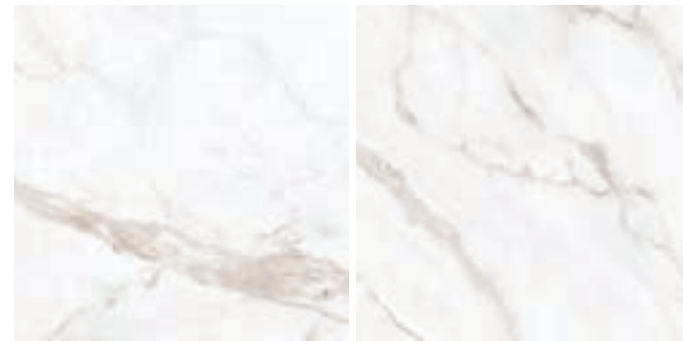

racer crema

PACKING & SPECIAL PIECES

	Pc/Cj	M2/Cj	Cj/Pl	M2/Pl	Kg/Cj	Kg/Pl
60,8x60,8	5	1,85	30	55,5	34	1040
60x120	2	1,44	36	51,84	29,5	1091

	Gloss	Rect. Gloss	Matt	Rect. Matt
60,8x60,8	MP141	-	MP140	-
60x120	-	MP181	-	MP180

Ver página 428
See page 428

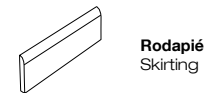

Rodapié
Skirting

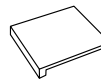

Peldaño
Step

Racer blanco 60x120 / 24"x48"



matt collection



Los modelos Ziro gris 60x60 y Southrock perla, gris y marengo 45x45 se pueden suministrar antideslizantes.
 Ziro gris 60x60 and Southrock perla, gris and marengo 45x45 size can be supplied non-slip.
 Ziro gris 60x60 et Southrock perla, gris and marengo 45x45 peut être fourni antidérapant.
 Ziro gris 60x60 und Southrock perla, gris and marengo 45x45 kann rutschfest geliefert werden.

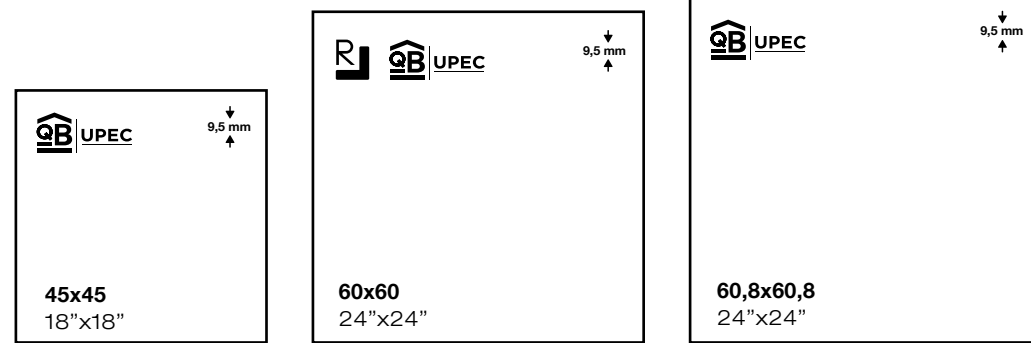

PACKING & SPECIAL PIECES

	Pc/Cj	M2/Cj	Cj/PI	M2/PI	Kg/Cj	Kg/PI
45x45	6	1,22	52	63,44	25,8	1361,6
60x60	4	1,44	30	43,2	31,4	962
60,8x60,8	4	1,48	30	44,4	31,35	960,5

	Cód.	ADZ
Antibes 45x45	MP136	-
Antibes 60x60	MP175	-
Berlín 45x45	MP132	-
Berlín 60,8x60,8	MP160	-
Southrock	MP136	MP135
Ziro 45x45	MP136	-
Ziro 60x60	MP175	-

Ver página 428
See page 428



Rodapié
Skirting

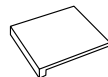

Peldaño
Step

Ziro perla 60x60 / 24"x24"

ANTIBES 45X45 / 60X60 / R10



ivory

pearl

grey

dark grey

BERLÍN 45X45 / 60,8X60,8



perla

gris

SOUTHROCK 45X45



perla

gris

marengo

ZIRO 45X45 / 60X60 / R10

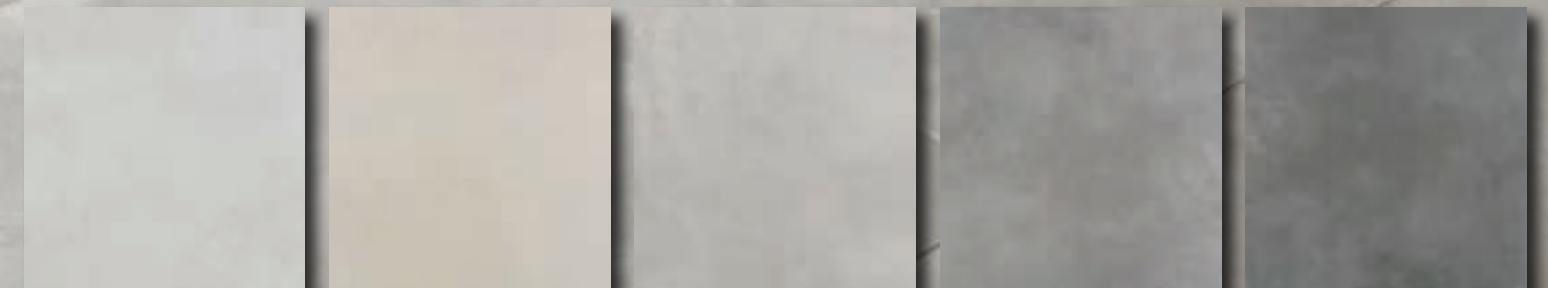

blanco

crema

perla

gris

marengo

glossy collection

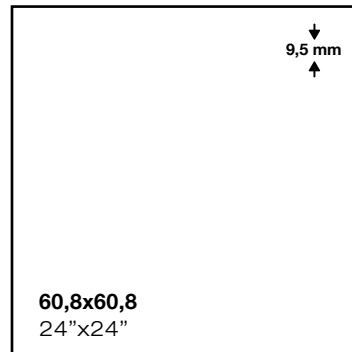

PACKING & SPECIAL PIECES

	Pc/Cj	M2/Cj	Cj/PI	M2/PI	Kg/Cj	Kg/PI
60,8x60,8	4	1,48	30	44,4	31,35	960,5

	Cód.		Cód
Calacatta	MP161	Daino	MP161
Taban	MP141	Reness	MP161
Luany	MP161	Cheyenne	MP141

Ver página 428
See page 428



Rodapié
Skirting

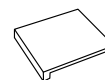

Peldaño
Step

Luany perla 60,8x60,8 / 24"x24"



calacatta blanco

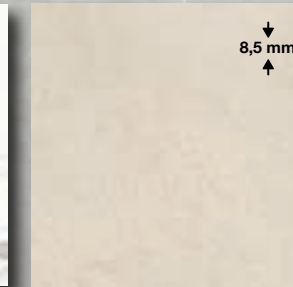

taban marfil



luany crema

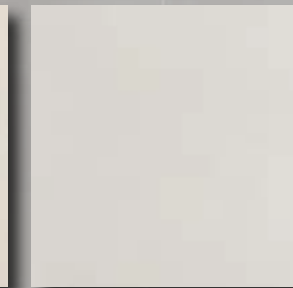

luany perla

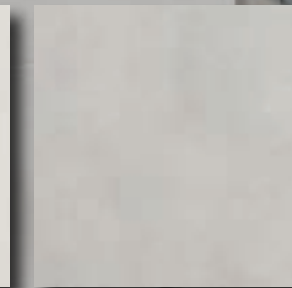

luany gris

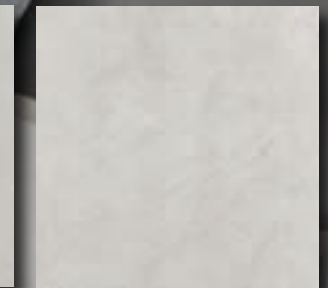

cheyenne perla

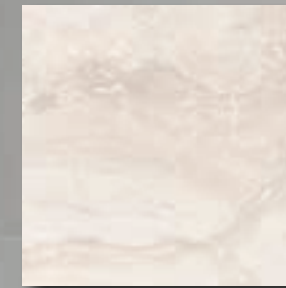

daino reale crema

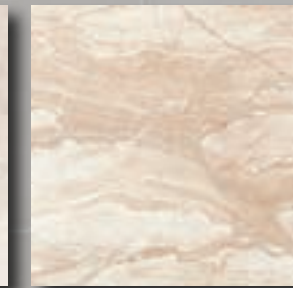

daino reale beige

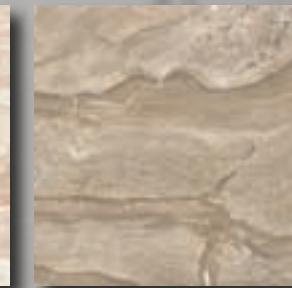

daino reale natural

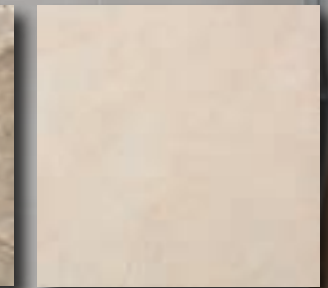

cheyenne crema

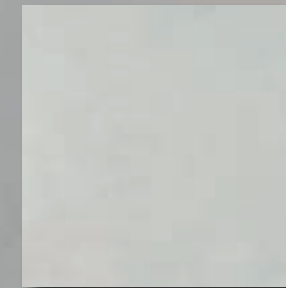

reness perla

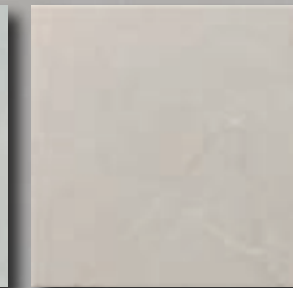

reness crema



reness gold

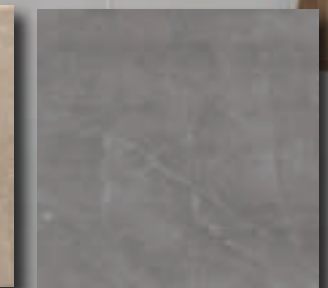

reness gris



ES

Su espesor de 6 MM, es lo que da nombre a esta nueva tipología de producto, que se caracteriza por su ligereza, reducido espesor, versatilidad y resistencia.

EN

6 MM thickness is what gives its name to this new product type, which is characterized by as lightness, reduced thickness, versatility and resistance.

FR

Son épaisseur de 6 MM est ce qui donne son nom à ce nouveau type de produit, qui est caractérisé par sa légèreté, son épaisseur réduite, sa polyvalence et sa résistance.

DE

Seine Stärke von 6 mm gibt diesem neuartigen Produkt seinen Namen zeichnet sich durch Leichtigkeit, geringe Dicke, Vielseitigkeit und Widerstandsfähigkeit aus.

SP
SIX MM PORCELAIN

BIRD•FOLK



ECOLÓGICO

Su espesor nos permite reducir la materia prima necesaria y la energía utilizada para su producción. Además, ocupa menos espacio, lo que hace que se puedan transportar más m² con menos emisiones de CO₂



LIGERO

Sus 6mm de espesor, hacen estas colecciones tan ligeras como manejables. Esta cualidad se hace evidente en el momento de su colocación, facilitándola sobre todo, en formatos más grandes.



FINO

El espesor de esta nueva familia de porcelánico la hace especial. Tan solo sostener una pieza es suficiente para captar las ventajas de su reducido espesor, como su manejabilidad y versatilidad.

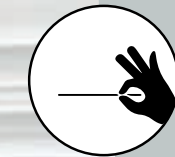

VERSÁTIL

Son innumerables las ventajas de esta nueva familia de espesor reducido, tanto en su fabricación y colocación, como en su transporte, ya que gracias a su espesor, sus cajas contienen mayor número de piezas.



ECOLÓGICAL

Its thickness allows us to reduce the raw material needed and the energy used for its production. Besides, it occupies less space, allowing more m² to be transported with less CO₂ emissions.

LIGHT

Its 6mm thickness makes these collections as light as manageable. This quality becomes obvious in the moment of installation, facilitating it especially in larger formats.

THIN

The thickness of this new porcelain family makes it special. It is enough to hold one piece in order to understand the advantages of its reduced thickness, as well as its easy handling and versatility.

VERSATILE

There are unnumbered advantages of this new family of reduced thickness, as much as in its manufacture and installation, as well as in their transport, because thanks to their thickness, their boxes contain a larger number of pieces.

folk



PO



6MM



No trabado mitad de pieza
Not brick-jointed halfway

6MM

pavimento _ porcelánico _ no rectificado _ mate
floor tile _ porcelain _ non rectified _ matt

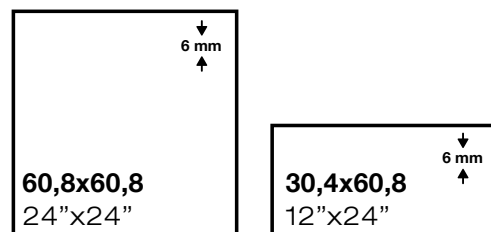

Folk marengo 60,8x60,8_24x24"

PACKING & SPECIAL PIECES

	Pc/Cj	M2/Cj	Cj/PI	M2/PI	Kg/Cj	Kg/PI	Cód.
30,4x60,8	9	1,66	60	99,6	25	1520	MP112
60,8x60,8	5	1,85	30	55,5	34	1040	MP137

Ver página 428
See page 428



Rodapié
Skirting

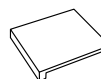

Peldaño
Step



bird

6MM



pavimento _ porcelánico _ no rectificado _ mate
 floor tile _ porcelain _ non rectified _ matt

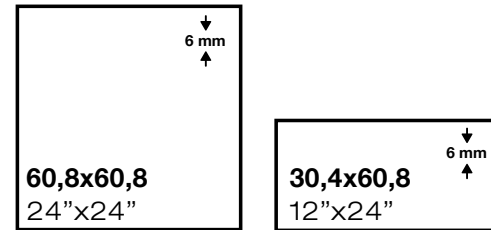

Bird hueso 30,4x60,8_12x24" / Bird gris 60,8x60,8_24x24"

PACKING & SPECIAL PIECES

	Pc/Cj	M2/Cj	Cj/PI	M2/PI	Kg/Cj	Kg/PI	Cód.
30,4x60,8	9	1,66	60	99,6	25	1520	MP112
60,8x60,8	5	1,85	30	55,5	34	1040	MP137

Ver página 428
 See page 428

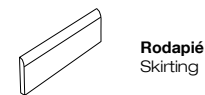

Rodapié
 Skirting

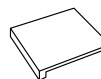

Peldaño
 Step

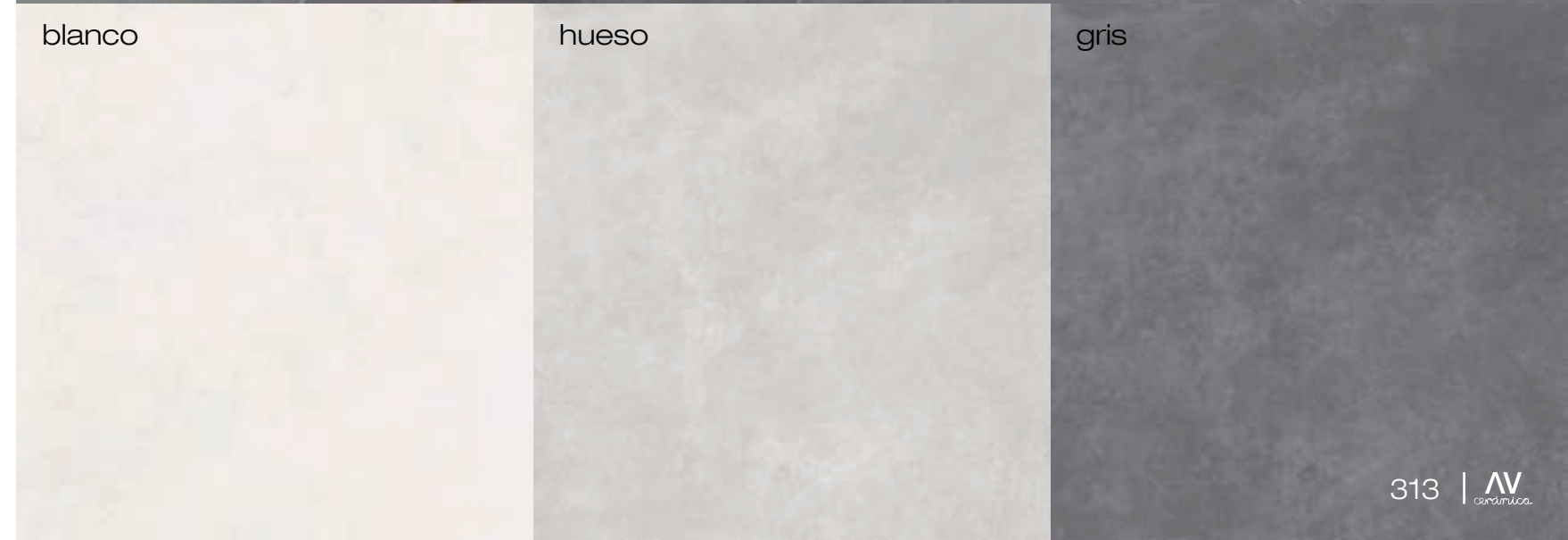

ES

Destinada para revestimiento, con ella se consiguen relieves más trabajados, que el bizcocho sea blanco también ayuda a la luminosidad del producto.

EN

Intended for coating, with it more worked reliefs are achieved, the fact that the cake is white also helps the luminosity of the product.

FR

Destiné à l'enrobage, on obtient avec lui des reliefs plus élaborés, le fait que le gâteau soit blanc contribue également à la luminosité du produit.

DE

Zum Überziehen gedacht, damit erzielen Sie aufwändigere Reliefs, die Tatsache, dass die Scherbe weiß ist, trägt auch zur Leuchtkraft des Produkts bei.

WVB

WHITE BODY WALL TILE

TERRANOVA • SANDRA • ZIRO • ANNIE • BELLAGIO • CARRA
CERES • DRAVA • IRIS • LITHOS • MANHATTAN • NATURE • SERENE
TIMISOARA • ANTIBES • NATIVE • DAFFEN • ETHAN • KAMEN

manhattan

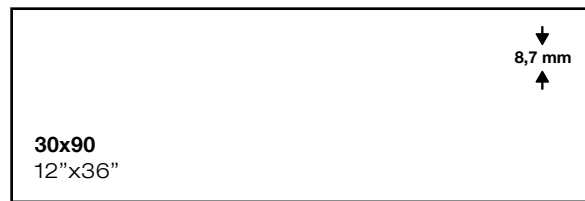

PAVIMENTO COORDINADO
coordinated floor tile
MANHATTAN
Pág. 258



PACKING & SPECIAL PIECES

	Pc/Cj	M2/Cj	Cj/Pl	M2/Pl	Kg/Cj	Kg/Pl
30x90	5	1,35	63	85,05	20,22	1298,86
30x90 Rlv	5	1,35	63	85,05	20,22	1298,86

	Cód.		Cód.
Manhattan	MB140	Rlv Manhattan	MB145

Manhattan grey 30x90 / 12"x36" _ Rlv Manhattan grey 30x90 / 12"x36"

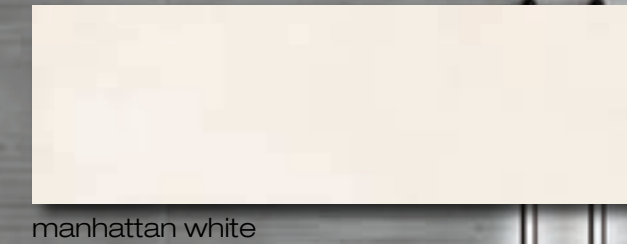

manhattan white

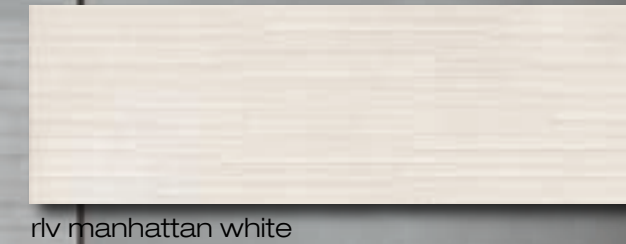

rlv manhattan white

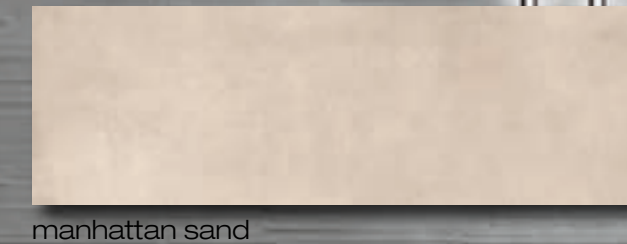

manhattan sand



rlv manhattan sand

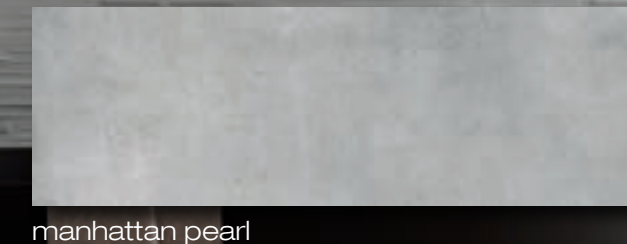

manhattan pearl



rlv manhattan pearl

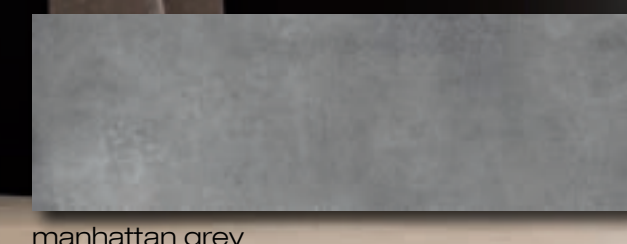

manhattan grey

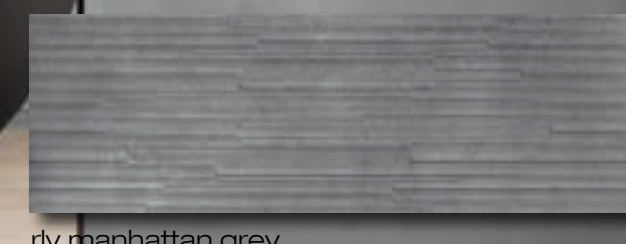

rlv manhattan grey

serene

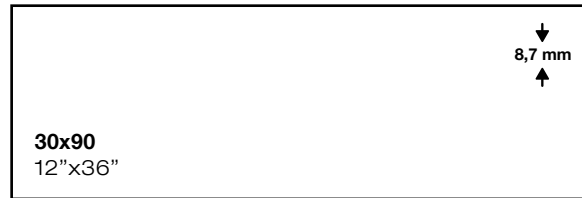

PAVIMENTO COORDINADO
coordinated floor tile

SERENE
Pág. 260



PACKING & SPECIAL PIECES

	Pc/Cj	M2/Cj	Cj/PI	M2/PI	Kg/Cj	Kg/PI
30x90	5	1,35	63	85,05	20,22	1298,86
30x90 Rlv	5	1,35	63	85,05	20,22	1298,86

	Cód.	
Serene	MB140	Rlv Serene MB145

Serene blanco / Rlv Serene blanco 30x90 / 12"x36"



serene blanco

rlv serene blanco

serene perla

rlv serene perla

serene gris

rlv serene gris

drava

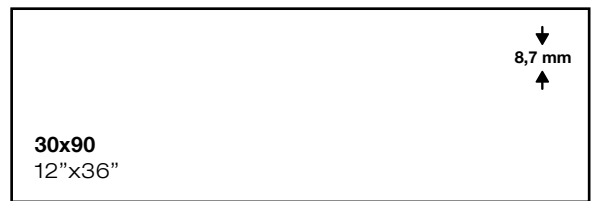

PAVIMENTO COORDINADO
coordinated floor tile

DRAVA / 60,8X60,8 cm

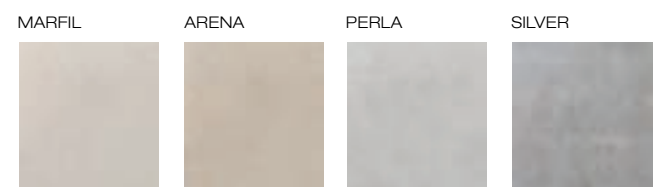

PACKING & SPECIAL PIECES

	Pc/Cj	M2/Cj	Cj/PI	M2/PI	Kg/Cj	Kg/PI
30x90	5	1,35	63	85,05	20,22	1298,86
30x90 Rlv	5	1,35	63	85,05	20,22	1298,86

	Cód.	Cód.
Drava	MB140	MB145
	Rlv Don / Upa	
	Dc Saale	MB146

Drava marfil / Rlv Don marfil / 30x90 / 12"x36"

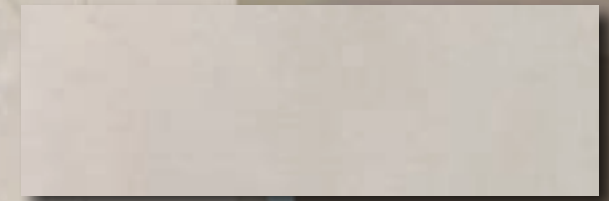

drava marfil

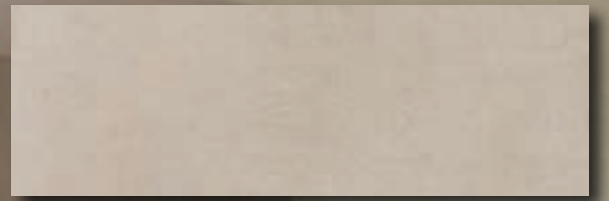

drava arena

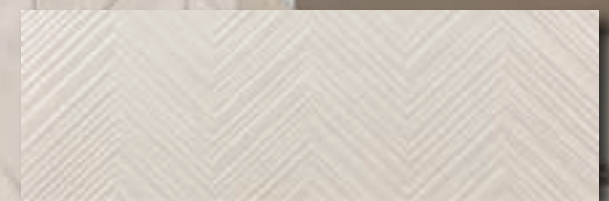

rlv upa marfil

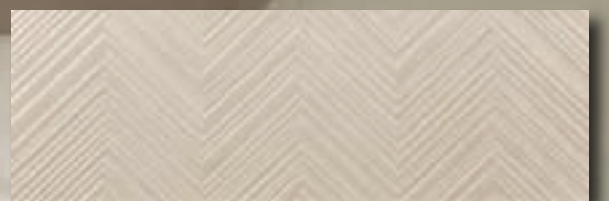

rlv upa arena

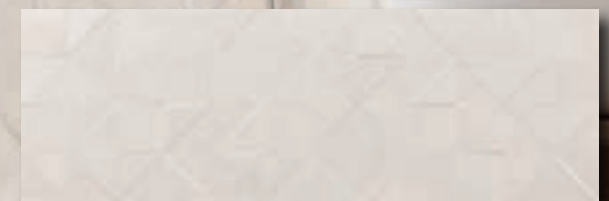

rlv don marfil

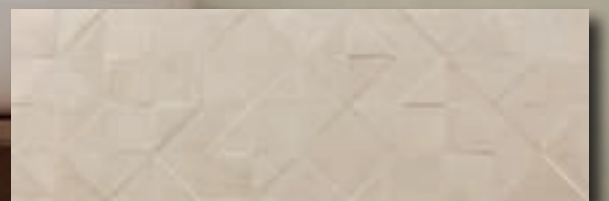

rlv don arena

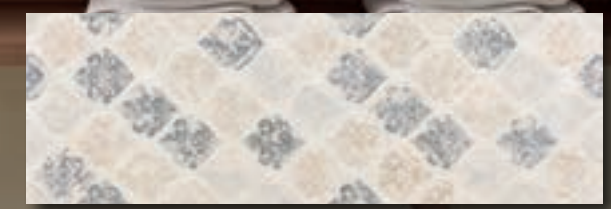

dc saale mix

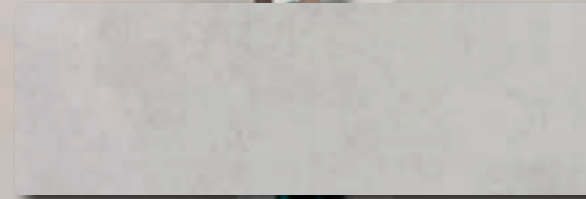

drava perla

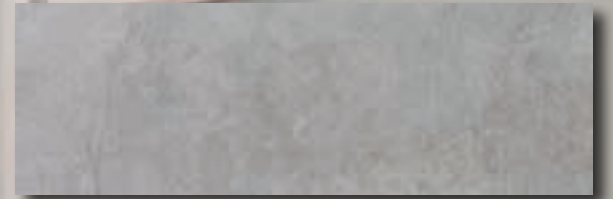

drava silver

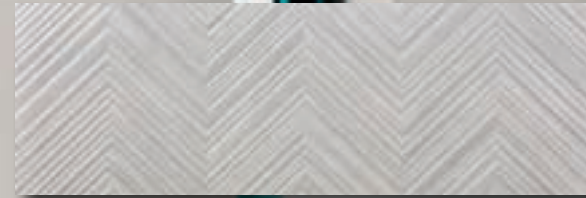

rlv upa perla



rlv upa silver

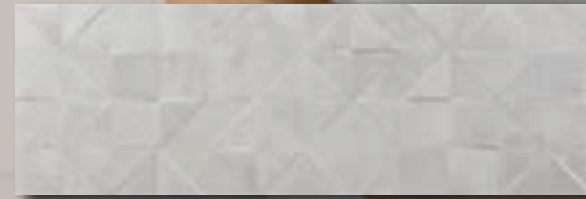

rlv don perla



rlv don silver



dc saale mix

lithos

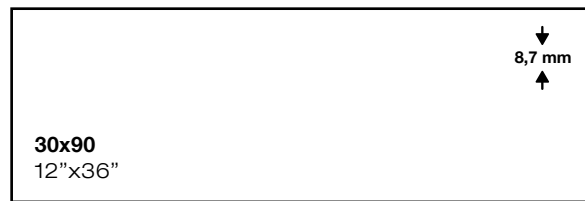

PAVIMENTO RECOMENDADO
recommended floor tile

FANLO / 25X150 cm

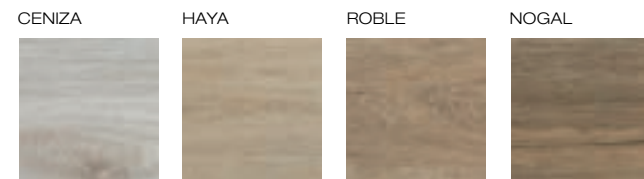

PACKING & SPECIAL PIECES

	Pc/Cj	M2/Cj	Cj/PI	M2/PI	Kg/Cj	Kg/PI
30x90	5	1,35	63	85,05	20,22	1298,86
30x90 Rlv	5	1,35	63	85,05	20,22	1298,86

	Cód.		Cód.
Lithos	MB140	Rlv Tye	MB145

Lithos pearl / Rlv Lithos pearl 30x90 / 12"x36"



lithos pearl

rlv tye pearl

lithos grey

rlv tye grey

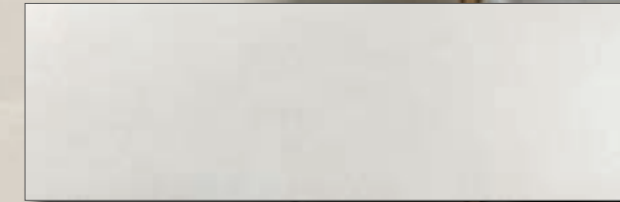

lithos white



riv tye white

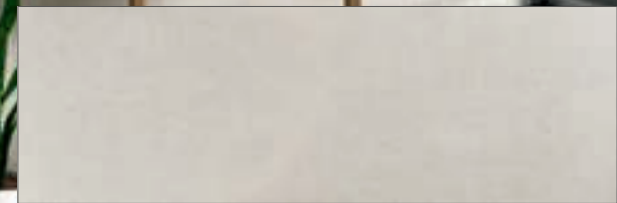

lithos beige

antibes

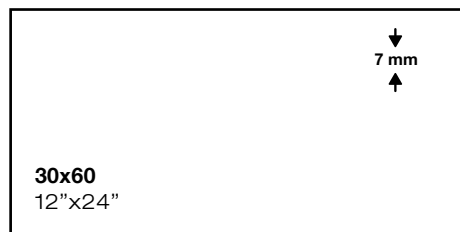

PAVIMENTO COORDINADO
coordinated floor tile

ANTIBES
Pág. 16

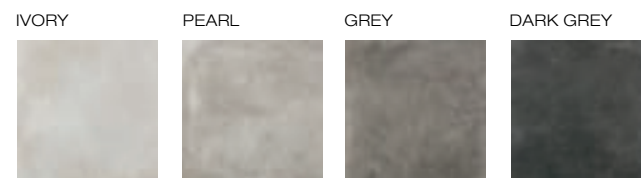

PACKING & SPECIAL PIECES

	Pc/Cj	M2/Cj	Cj/PI	M2/PI	Kg/Cj	Kg/PI
30x60	9	1,62	60	97,2	20	1220

	Cód.
Antibes	MB130

Antibes ivory 30x60 / 12"x24"

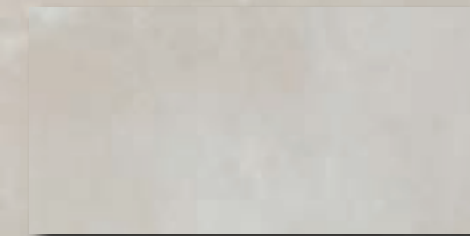

antibes ivory

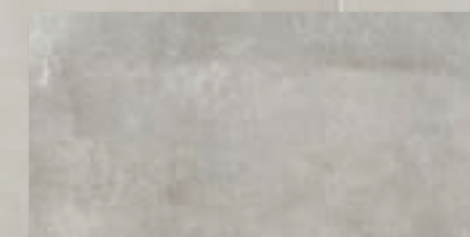

antibes pearl



antibes grey

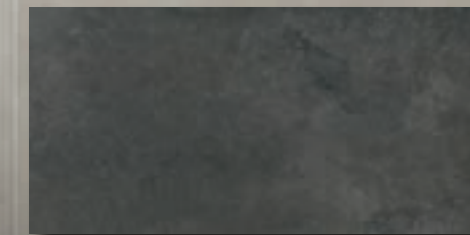

antibes dark grey

ziro

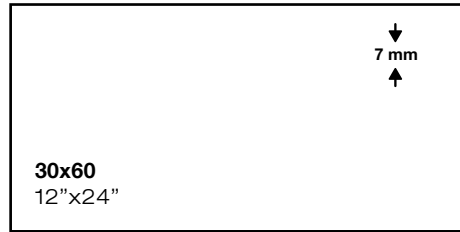

PAVIMENTO COORDINADO
coordinated floor tile

ZIRO
Pág. 20

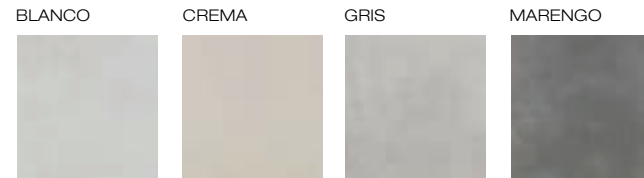

PACKING & SPECIAL PIECES

	Pc/Cj	M2/Cj	Cj/PI	M2/PI	Kg/Cj	Kg/PI
30x60	9	1,62	60	97,2	20	1220

	Cód.
Ziro	MB130

Ziro gris 30x60 / 12"x24" Tabil light 20x120 / 8"x48"

ziro blanco

ziro beige

ziro gris

ziro marengo



ziro



PAVIMENTO COORDINADO
coordinated floor tile

ZIRO
Pág. 20

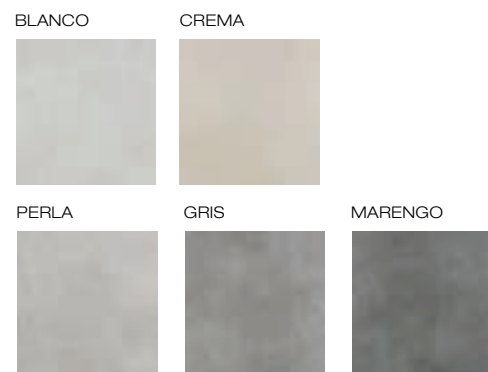

PACKING & SPECIAL PIECES

	Pc/Cj	M2/Cj	Cj/PI	M2/PI	Kg/Cj	Kg/PI
36x80	4	1,15	54	62,1	19,2	1056,8

	Cód.	Cód.
Ziro	MB120	MB125

Dc Bree / Ergo MB126

Ziro crema / Rlv Kata crema 36x80 / 14"x32" _ Ziro crema 45x45 / 18"x18"



ziro blanco

rlv kata blanco

ziro crema

rlv kata crema

*dc bree

*dc ergo

* Diferentes diseños en una caja / Mixed designs in each box

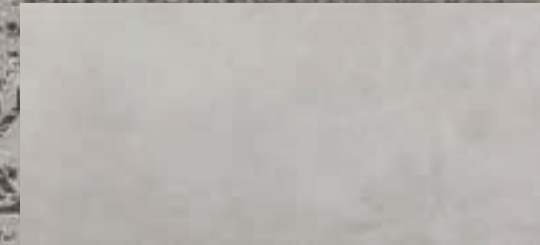

ziro perla



rlv kata perla

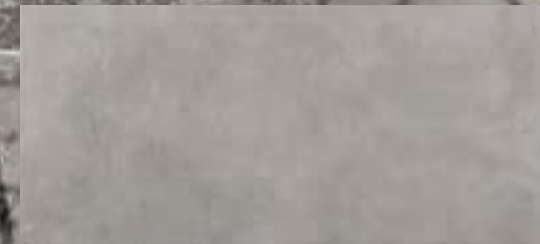

ziro gris

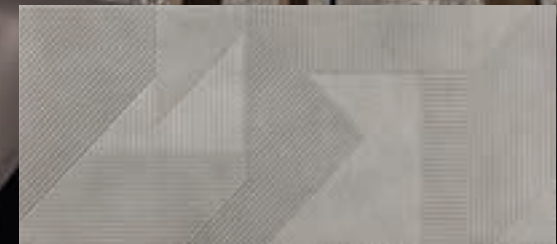

rlv kata gris

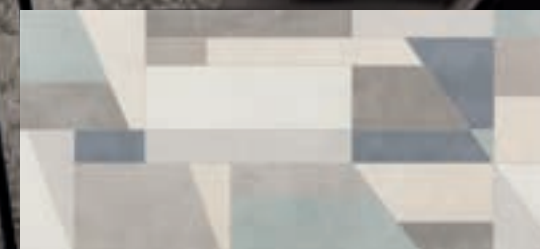

*dc bree



*dc ergo

* Diferentes diseños en una caja / Mixed designs in each box

nature



PAVIMENTO COORDINADO
coordinated floor tile
NATURE
Pág. 264



PACKING & SPECIAL PIECES

	Pc/Cj	M2/Cj	Cj/PI	M2/PI	Kg/Cj	Kg/PI
30x90	5	1,35	63	85,05	20,22	1298,86
30x90 Rlv	5	1,35	63	85,05	20,22	1298,86

	Cód.	Cód.
Nature	MB140	Rlv Nature MB145

Nature gris / Rlv Nature gris 30x90 / 12"x36" _ Nature gris 60x60 / 24"x24"

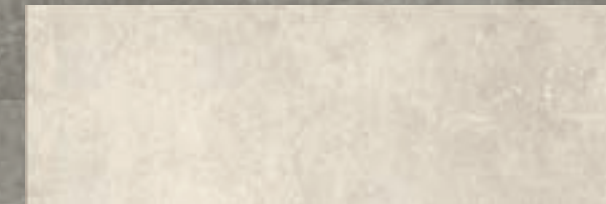

nature perla

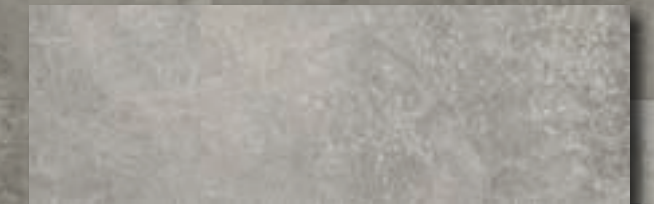

nature gris

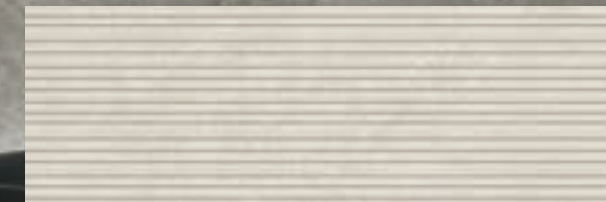

rlv nature perla

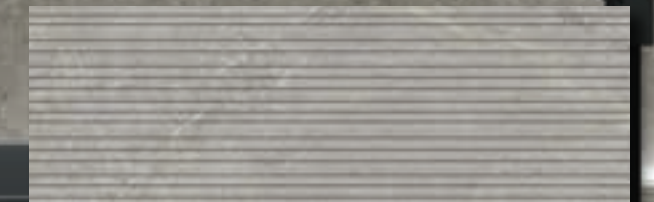

rlv nature gris

kamen



Kamen perla / Dc Lovret mix 33,3x100 / 13"x40"

PACKING & SPECIAL PIECES

	Pc/Cj	M2/Cj	Cj/PI	M2/PI	Kg/Cj	Kg/PI
33,3x100	6	2	48	96	24	1174
33,3x100 Riv	6	2	48	96	24	1174

	Cód.	Cód.
Kamen	MB150	Riv Bilice MB155
	Dc Lovret	MB156

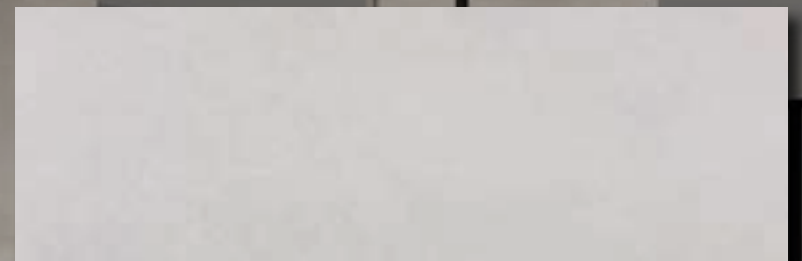

kamen perla

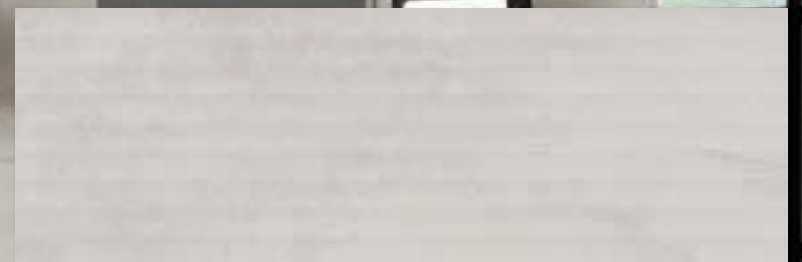

riv bilice perla



riv name perla

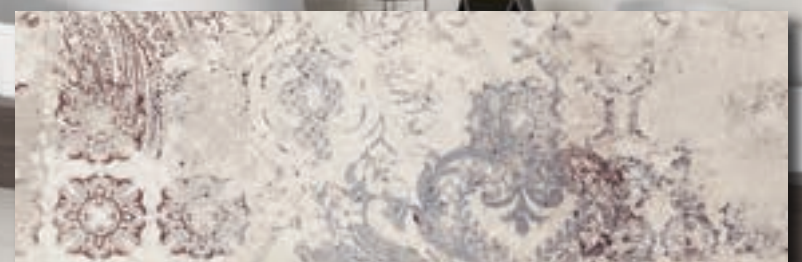

*dc lovret mix

* Diferentes diseños en una caja / Mixed designs in each box

Kamen marfil / Rlv Bilice marfil 33,3x100 / 13"x40" _ Kamen marfil 60,8x60,8 / 24"x24"

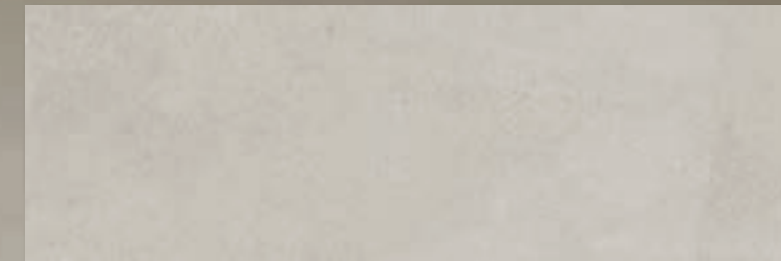

kamen marfil

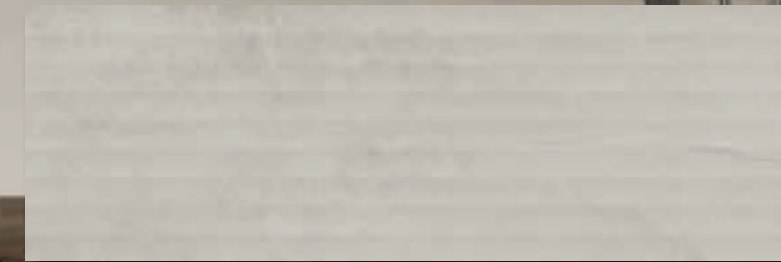

rlv bilice marfil



rlv name marfil

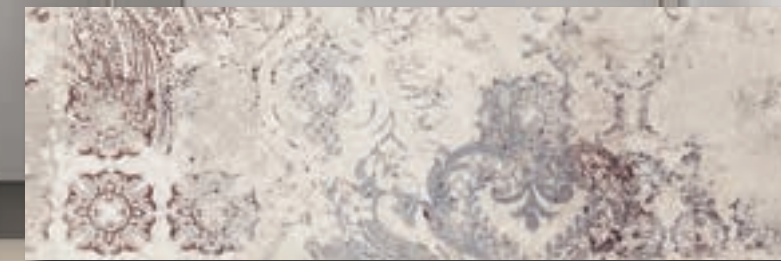

*dc lovret mix

* Diferentes diseños en una caja / Mixed designs in each box

ceres



PAVIMENTO RECOMENDADO
recommended floor tile

FANLO / 25X150 cm

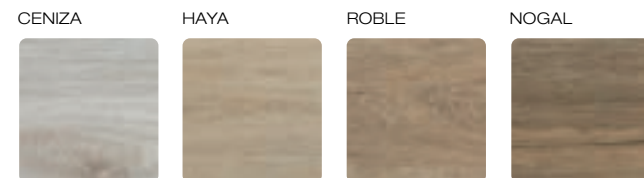

PACKING & SPECIAL PIECES

	Pc/Cj	M2/Cj	Cj/PI	M2/PI	Kg/Cj	Kg/PI
30x90	5	1,35	63	85,05	20,22	1293,86
30x90 Rlv	5	1,35	63	85,05	20,22	1293,86

	Cód.	Cód.
Ceres	MB140	Rlv Hoyo MB145

Ceres beige / Rlv Hoyo beige 30x90 / 12"x36"

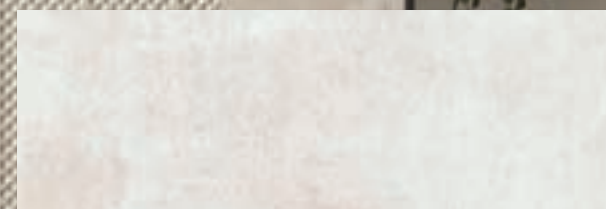

ceres blanco

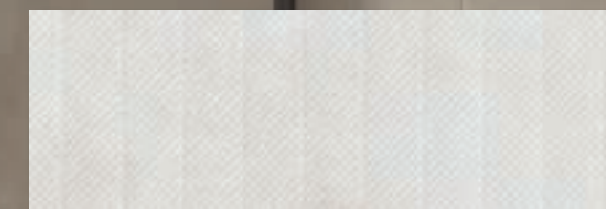

rlv hoyo blanco

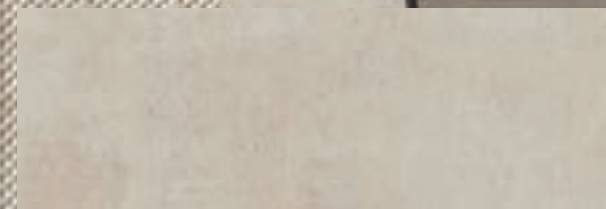

ceres beige



rlv hoyo beige

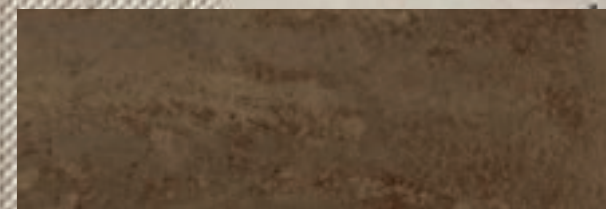

ceres óxido

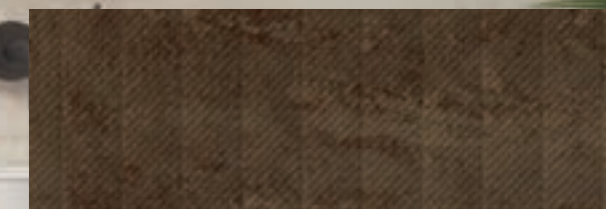

rlv hoyo óxido



ceres acero

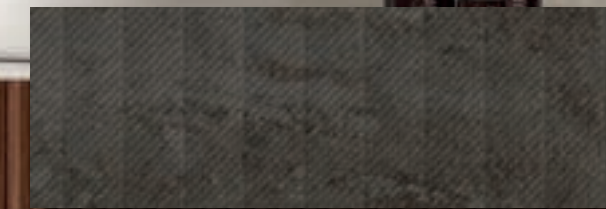

rlv hoyo acero

bellagio



PAVIMENTO COORDINADO
coordinated floor tile

BELLAGIO / BELLAGIO GOLD
Pág. 292



PACKING & SPECIAL PIECES

	Pc/Cj	M2/Cj	Cj/PI	M2/PI	Kg/Cj	Kg/PI
30x90	5	1,35	63	85,05	20,22	1298,86
30x90 Rlv	5	1,35	63	85,05	20,22	1298,86

	Cód.		Cód.
Bellagio	MB140	Rlv Bellagio	MB145

Bellagio / Rlv Bellagio 30x90 / 12"x36"



bellagio

rlv bellagio

carra

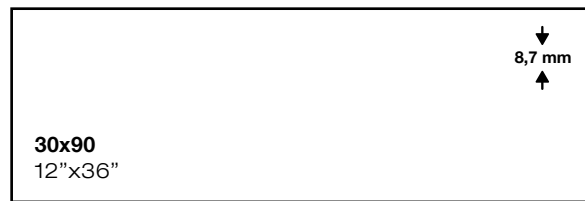

PAVIMENTO RECOMENDADO
recommended floor tile

VALDIVIA

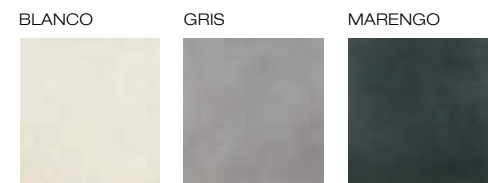

PACKING & SPECIAL PIECES

	Pc/Cj	M2/Cj	Cj/PI	M2/PI	Kg/Cj	Kg/PI
30x90	5	1,35	63	85,05	20,22	1298,86
30x90 Rlv	5	1,35	63	85,05	20,22	1298,86

	Cód.	Cód.
Carra	MB140	Rlv Carra MB145

Carra / Rlv Carra 30x90 / 12"x36"

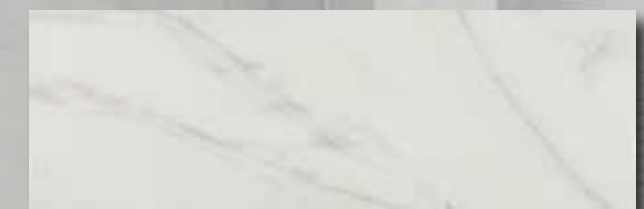

carra

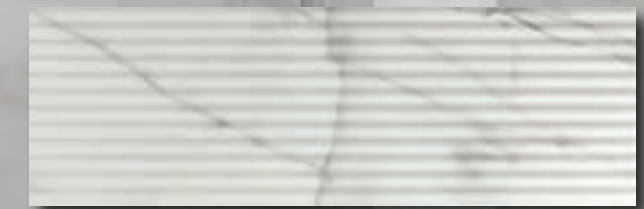

rlv carra

native



PAVIMENTO RECOMENDADO
recommended floor tile

FANLO / 25X150 cm



PACKING & SPECIAL PIECES

	Pc/Cj	M2/Cj	Cj/PI	M2/PI	Kg/Cj	Kg/PI
30x90	5	1,35	63	85,05	20,22	1298,86
30x90 Rlv	5	1,35	63	85,05	20,22	1298,86

	Cód.		Cód.
Native	MB140	Dc Indio	P815

Native white 30x90 / 12"x36" _ Native nut 30x90 / 12"x36" _ Fanlo ceniza 20x120 / 8"x48"



native white

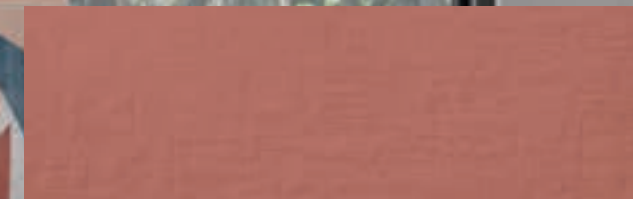

native terra

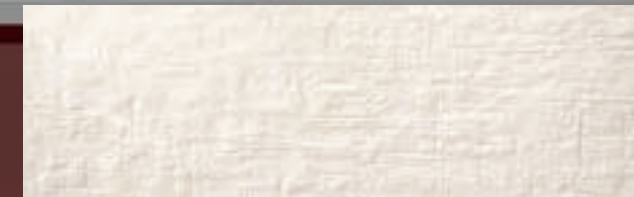

native ivory

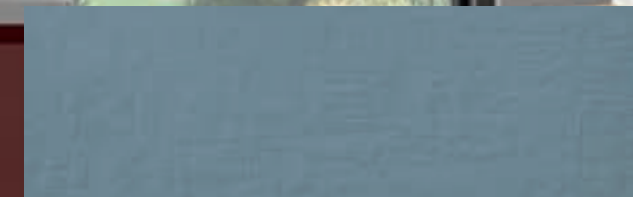

native navy

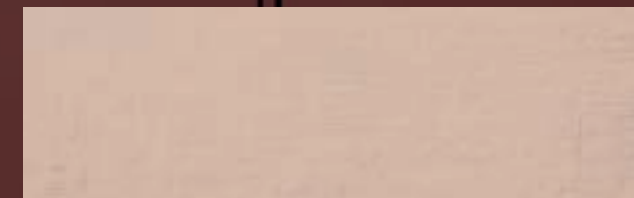

native nut

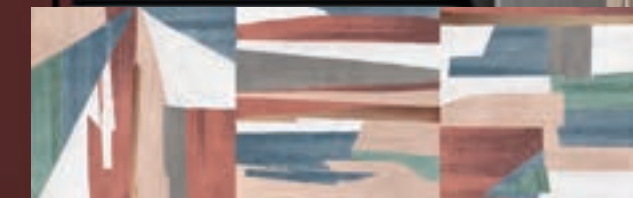

dc indio

iris

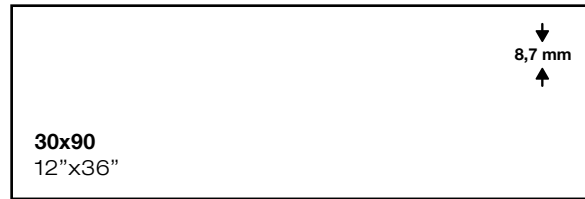

PIEZAS ESPECIALES
special pieces

MALLAS / 30X30 cm



Iris ivory / Dc Canvas 30x90 / 12"x36"

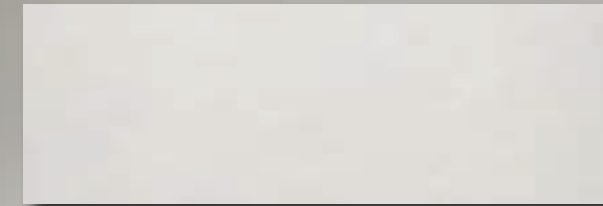

iris snow

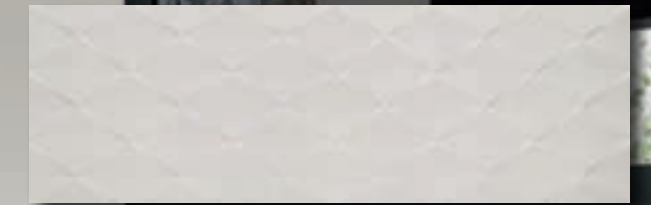

rlv icon snow

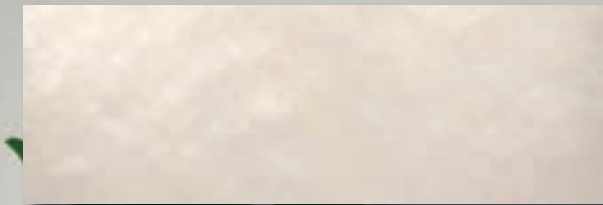

iris ivory

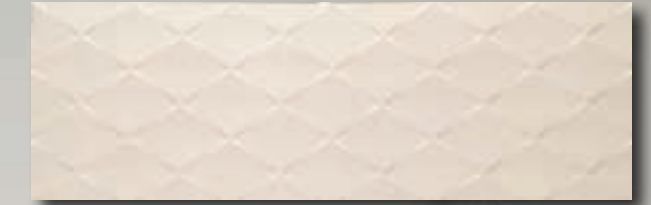

rlv icon ivory

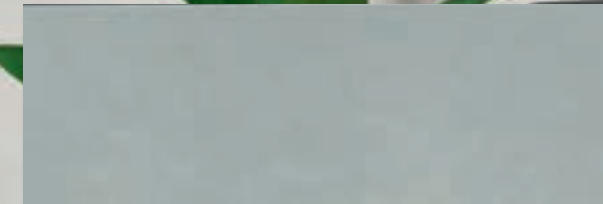

iris acqua



rlv icon acqua



*dc canvas

* Diferentes diseños en una caja / Mixed designs in each box

PACKING & SPECIAL PIECES

	Pc/Cj	M2/Cj	Cj/PI	M2/PI	Kg/Cj	Kg/PI
30x90	5	1,35	63	85,05	20,22	1298,86
30x90 Rlv	5	1,35	63	85,05	20,22	1298,86

	Cód.	Cód.
Iris	MB140	MB145
Malla	P859	MB146

annie / timisoara

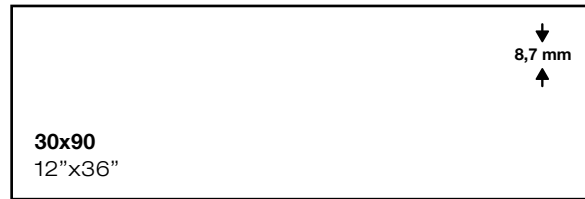

PAVIMENTO RECOMENDADO
recommended floor tile

METHOD



Annie / Rlv Galagos mate 30x90 / 12"x36"

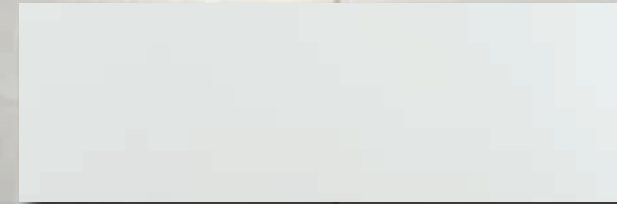

annie

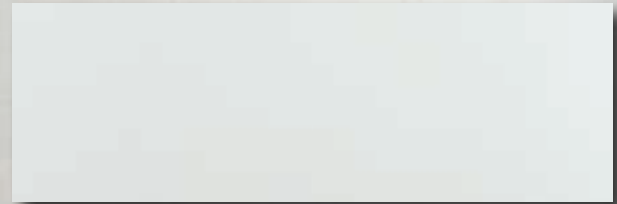

timisoara

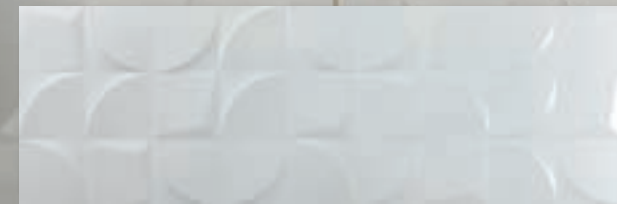

rlv galagos mate

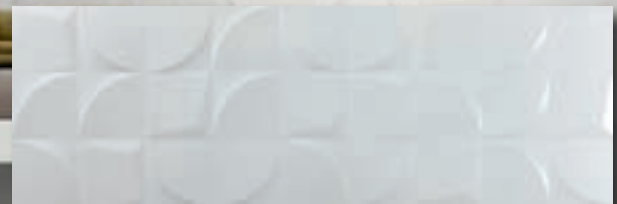

rlv galagos brillo

PACKING & SPECIAL PIECES

	Pc/Cj	M2/Cj	Cj/PI	M2/PI	Kg/Cj	Kg/PI
30x90	5	1,35	63	85,05	20,22	1298,86
30x90 Rlv	5	1,35	63	85,05	20,22	1298,86

	Cód.	Cód.
Annie / Timisoara	MB140	MB145
Rlv Galagos		

daffen / ethan



PAVIMENTO RECOMENDADO
recommended floor tile

FANLO / 25X150 cm



PACKING & SPECIAL PIECES

	Pc/Cj	M2/Cj	Cj/PI	M2/PI	Kg/Cj	Kg/PI
33,3x100	6	2	48	96	24	1174
33,3x100 Rlv	6	2	48	96	24	1174

	Cód.	
Daffen / Ethan	MB150	Rlv Ted
		MB155
	Rlv Hanne	MB155

Daffen blanco / Rlv Ted brillo 30x90 / 12"x36"

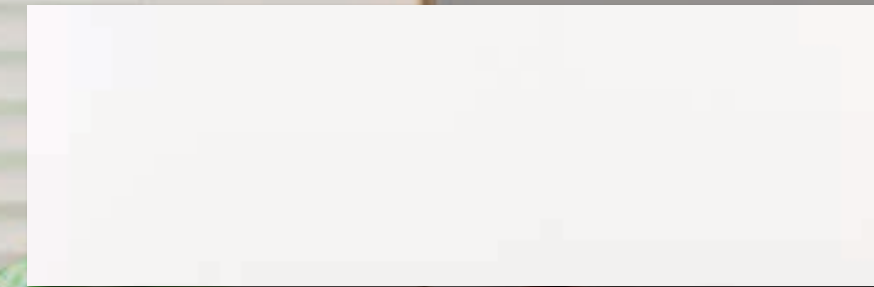

daffen blanco / ethan blanco

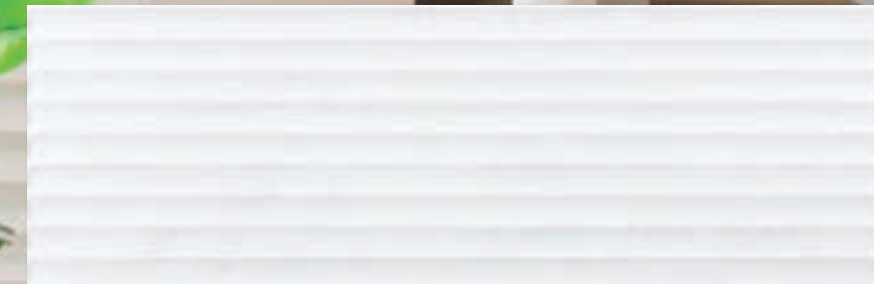

rlv ted brillo / mate

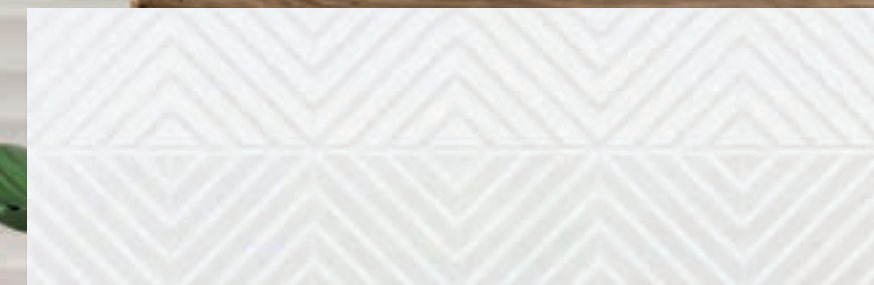

rlv hanne brillo / mate

sandra / terranova



PAVIMENTO RECOMENDADO
recommended floor tile

METHOD



PACKING & SPECIAL PIECES

	Pc/Cj	M2/Cj	Cj/PI	M2/PI	Kg/Cj	Kg/PI
36x80	4	1,15	54	62,1	19,2	1056,8

	Cód.		Cód.
Sandra / Terranova	MB120	Rlv Sandra / Terranova	MB125
		Rlv Noon / Indoc	MB125

Sandra / Rlv Noon 36x80 / 14"x32" _ Southrock perla 45x45 / 18"x18"

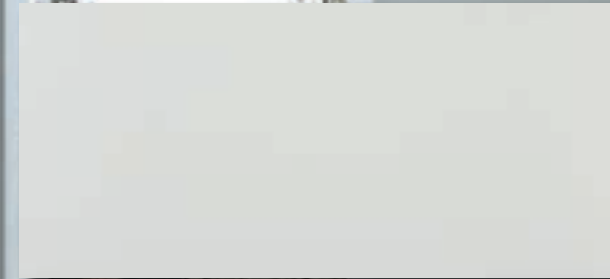

sandra

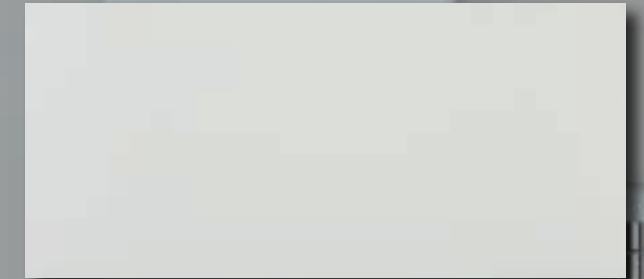

terranova

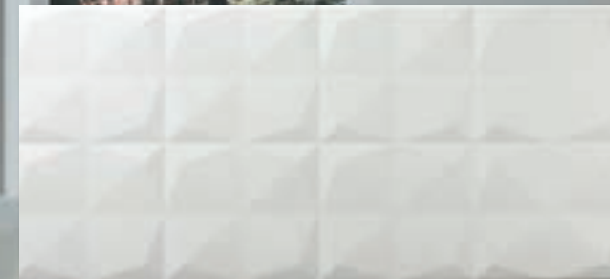

rlv sandra / matt

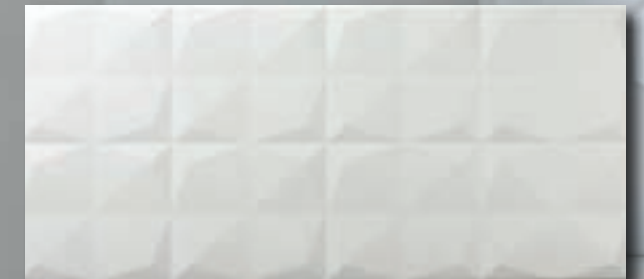

rlv terranova / gloss



rlv noon / matt

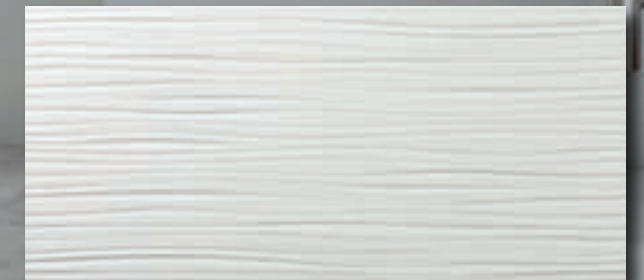

rlv indoc / gloss

ES

El más antiguo, ya que hasta hace unos años era el producto cerámico principal, con menos resistencia que el porcelánico, pero ideal para interiores de vivienda. En brillo, mate y adz.

EN

The oldest, since until a few years ago it was the main ceramic product, with less resistance than porcelain, but ideal for home interiors. In gloss, matte and adz.

FR

Le plus ancien, puisque jusqu'à il y a quelques années, il s'agissait du principal produit céramique, avec moins plus résistante que la porcelaine, mais idéale pour les intérieurs de maison. En brillant, mat et adz.

DE

Das älteste, da es bis vor einigen Jahren das wichtigste Keramikprodukt war, mit weniger widerstandsfähiger als Porzellan, aber ideal für den Innenbereich. In Glanz, Matt und Adz.

RGB

RED BODY FLOOR TILE

FORESTA • FUSTA • TIOGA • MATT COLLECTION • GLOSSY COLLECTION
ALYSA • ATTIS • YASMINE

alysa



PACKING & SPECIAL PIECES

 **Ver página 427**
See page 427



	Pc/Cj	M2/Cj	Cj/PI	M2/PI	Kg/Cj	Kg/PI
45x90	5	2,03	42	85,26	38,6	1646,2
Cód.						
Alysa	MG125					



alysa blanco

alysa bone

alysa gris

Alysa gris 45x90 / 18"x36"

attis



RB



PACKING & SPECIAL PIECES



Ver página 427
See page 427

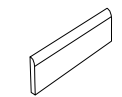

Rodapié
Skirting

	Pc/Cj	M2/Cj	Cj/PI	M2/PI	Kg/Cj	Kg/PI
45x90	5	2,03	42	85,26	38,6	1646,2
Cód.						
Attis	MG125					

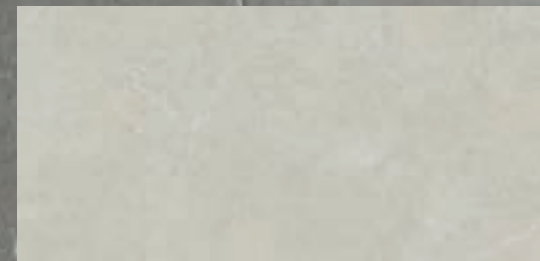

attis perla

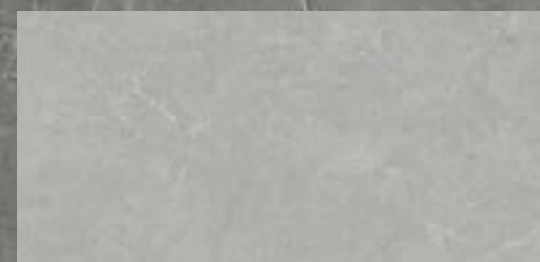

attis gris

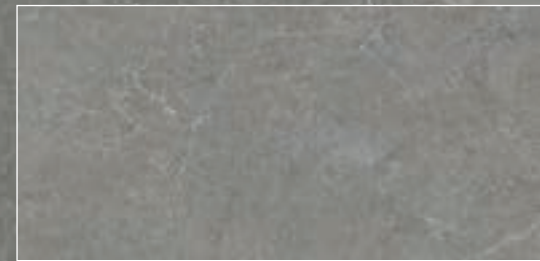

attis grafito



Attis grafito 45x90 / 18"x36"

yasmine



PACKING & SPECIAL PIECES

 **Ver página 427**
See page 427

 **Rodapié Skirting**

	Pc/Cj	M2/Cj	Cj/PI	M2/PI	Kg/Cj	Kg/PI
45x90	5	2,03	42	85,26	38,6	1646,2
Cód.						
Yasmine	MG125					

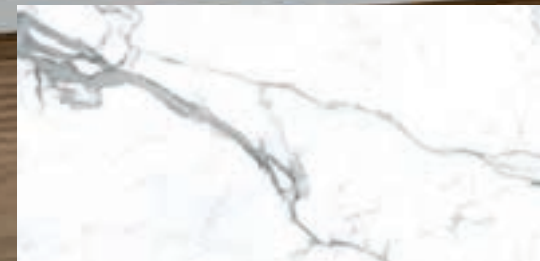

yasmine blanco

Yasmine blanco 45x90 / 18"x36"

foresta



20x60
8"x24"

↓
9,5 mm
↑

PACKING & SPECIAL PIECES

 **Ver página 427**
See page 427

 **Rodapié**
Skirting

	Pc/Cj	M2/Cj	Cj/PI	M2/PI	Kg/Cj	Kg/PI
20x60	9	1,08	80	86,4	21,08	1706,4
	Cód.					
20x60	MG120					

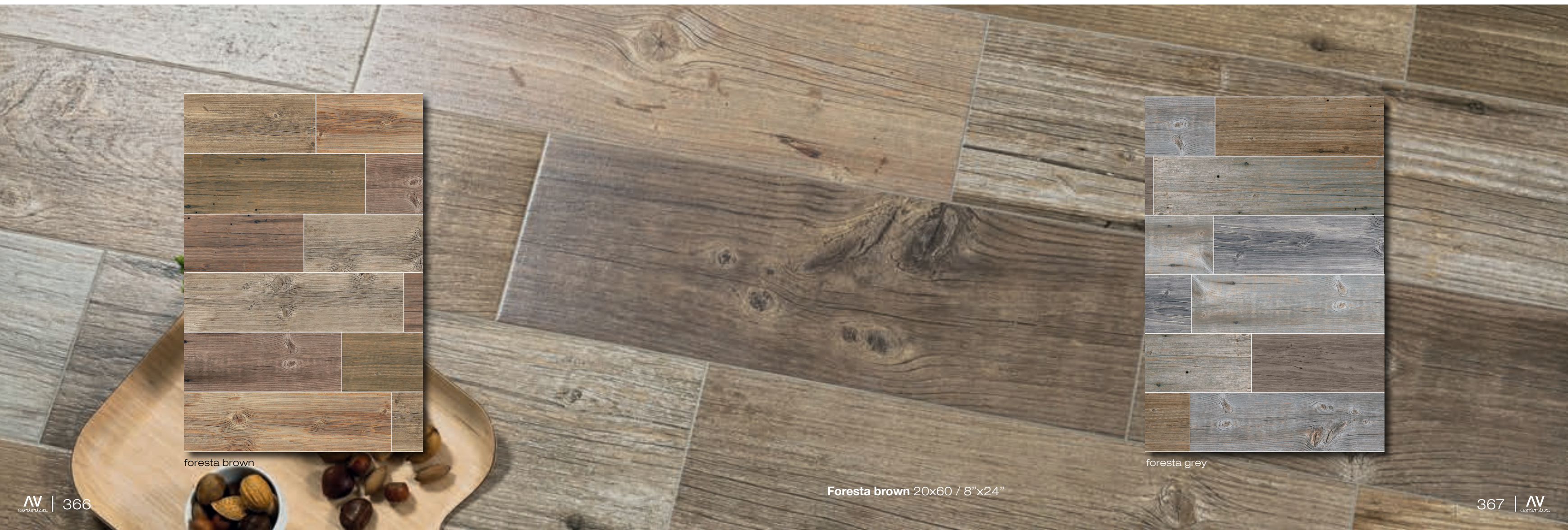

foresta brown



foresta grey

Foresta brown 20x60 / 8"x24"

fusta



20x60
8"x24"

9,5 mm

PACKING & SPECIAL PIECES

Ver página 427
See page 427

Rodapié
Skirting

	Pc/Cj	M2/Cj	Cj/Pl	M2/Pl	Kg/Cj	Kg/Pl
20x60	9	1,08	80	86,4	21,08	1706,4
	Cód.					
20x60	MG120					



fusta nogal



fusta roble



fusta wengue



fusta cerezo

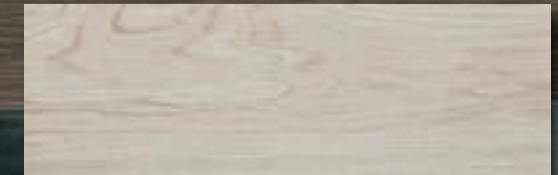

fusta haya

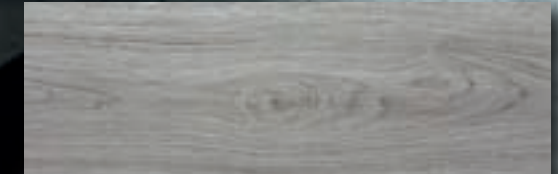

fusta marengo



fusta grafito

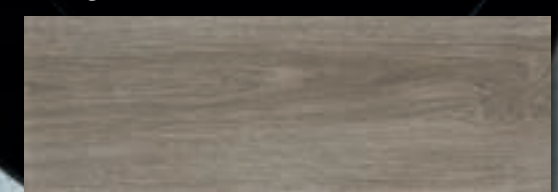

fusta musgo

Fusta wengue 20x60 / 8"x24"

tioga



20x60
8"x24"

↓
9,5 mm
↑

PACKING & SPECIAL PIECES

Ver página 427
See page 427



	Pc/Cj	M2/Cj	Cj/Pl	M2/Pl	Kg/Cj	Kg/Pl
20x60	9	1,08	80	86,4	21,08	1706,4
	Cód.					
20x60	MG120					



tioga crema

tioga nogal

tioga noce

tioga blanco

tioga gris

Tioga crema 20x60 / 8"x24"

gloss / matt collection

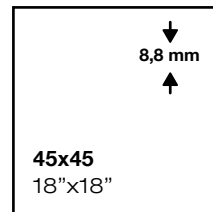

PACKING & SPECIAL PIECES

 **Ver página 427**
See page 427

 **Rodapié Skirting**

	Pc/Cj	M2/Cj	Cj/PI	M2/PI	Kg/Cj	Kg/PI
45x45	7	1,42	52	73,84	26	1372
	Cód.					
45x45	MG110					

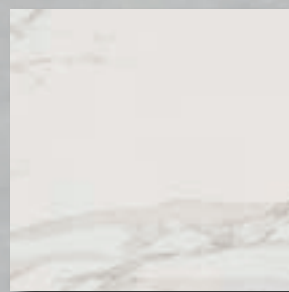

forum blanco

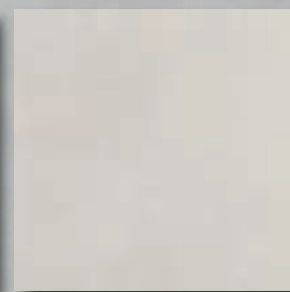

davis perla

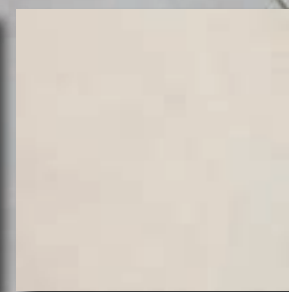

davis crema

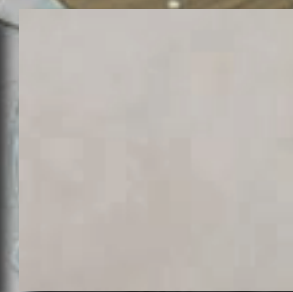

davis gris

Davis gris 45x45 / 18"x18"

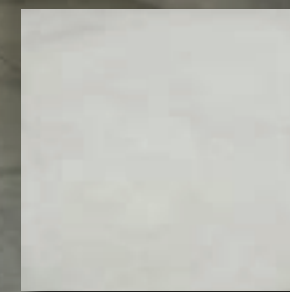

privilege perla

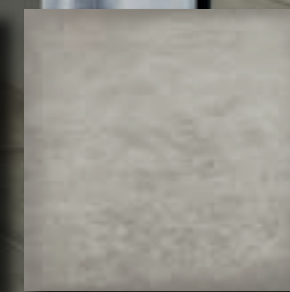

privilege marengo

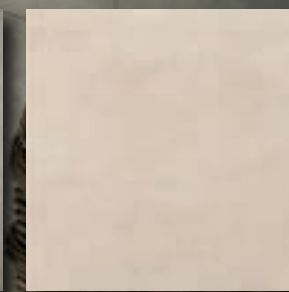

metalica marfil

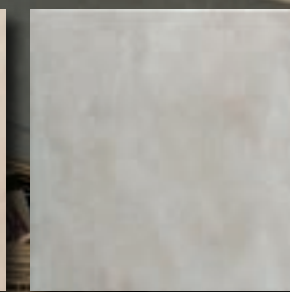

metalica gris

Privilege marengo 45x45 / 18"x18"

ES

El de siempre, el principio de todo, con la tecnología de los últimos años, una mezcla perfecta para cualquier tipo de estancia.

EN

The same as always, the beginning of everything, with the technology of recent years, a perfect mix for any type of stay.

FR

Comme toujours, le début de tout, avec la technologie de ces dernières années, un mélange parfait pour tout type de séjour.

DE

Wie immer, der Anfang von allem, mit der Technologie der letzten Jahre, eine perfekte Mischung für jede Art von Aufenthalt.

RB

RED BODY WALL TILE

BYRON • KEON • ATELERI • AZUR • DAFNE • MARBLEBRICK • FLAT • LAOS • MILER
RODANO • STUC • BETHEL • FLAT • ARTAN • AVART • CALACATTA • GUALDO • LENGU
NORTH • SENER • BLANCOS

bethel



30x90
12"x36"

↓
8,5 mm
↑

PAVIMENTO RECOMENDADO
recommended floor tile

■ TAIGA / 20X120 cm

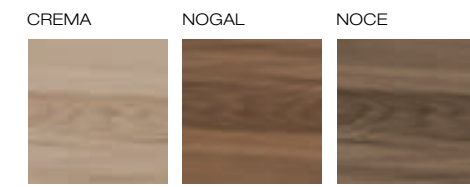

PACKING & SPECIAL PIECES

	Pc/Cj	M2/Cj	Cj/PI	M2/PI	Kg/Cj	Kg/PI
30x90	7	1,9	48	91,2	30,5	1479,7
	Cód.		Cód.		Cód.	
Bethel	MR160	Necker	MR165	Newhalen	MR165	

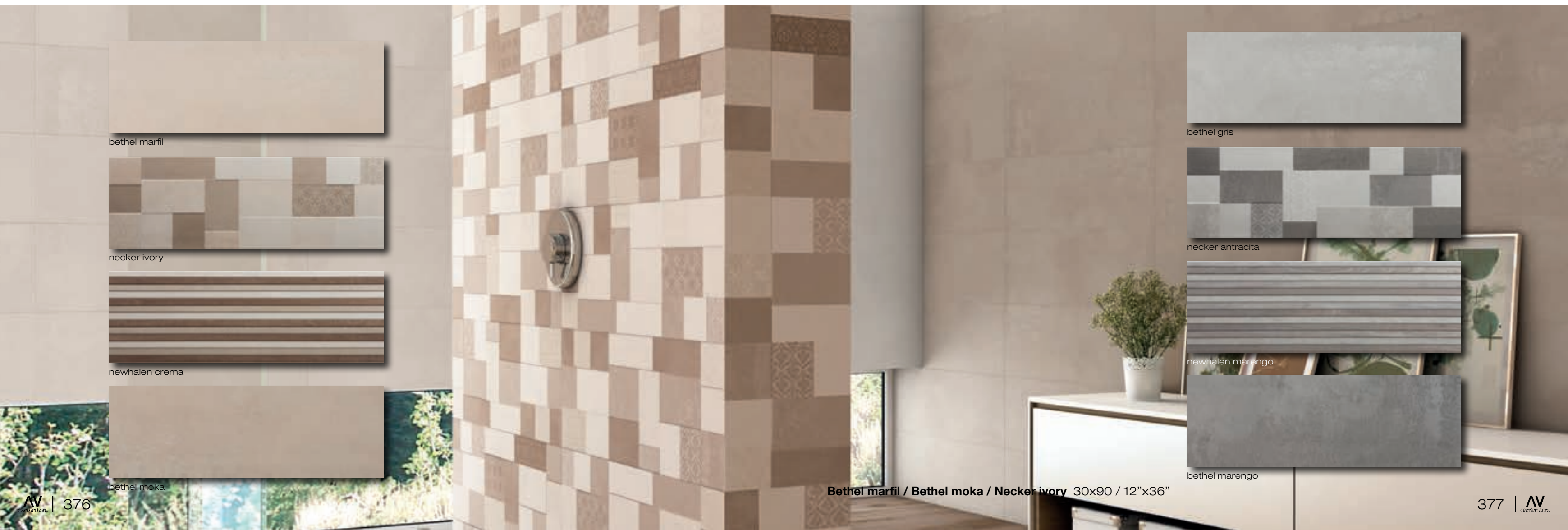

bethel marfil

necker ivory

newhalen crema

bethel moka

bethel gris

necker antracita

newhalen marenco

bethel marenco

Bethel marfil / Bethel moka / Necker ivory 30x90 / 12"x36"

stuc



25x70
10"x28"

8,5 mm

PAVIMENTO COORDINADO
coordinated floor tile

■ **DYLON** / 60,8X60,8 cm



* Diferentes diseños en una caja /
Mixed designs in each box

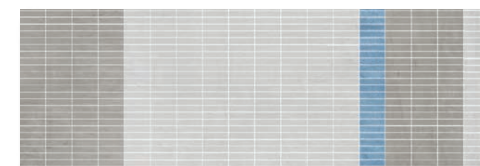

*dc link perla



*dc link marfil

PACKING & SPECIAL PIECES

	Pc/Cj	M2/Cj	Cj/PI	M2/PI	Kg/Cj	Kg/PI
25x70	9	1,58	64	101,12	24,64	1596,96
25x70 Riv	9	1,58	56	88,48	24,64	1399,84
	Cód.		Cód		Cód	
Stuc	MR150	Rlv Flavia / Smart	MR155	Dc Link	MR156	



stuc marfil



rlv flavia marfil

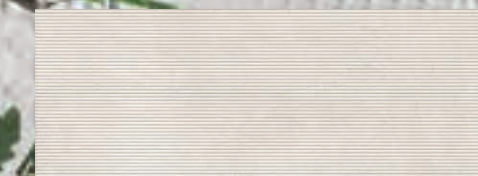

rlv smart marfil



stuc taupe



rlv flavia taupe

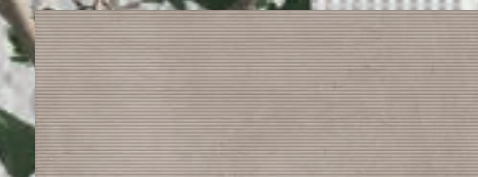

rlv smart taupe



stuc perla



rlv flavia perla



rlv smart perla



stuc gris



rlv flavia gris



rlv smart gris

Stuc perla / Rlv Flavia perla 25x70 / 10"x28"

miler



RB



GRUPO BIII

25x70
10"x28"

↓
8,5 mm
↑

PAVIMENTO COORDINADO
coordinated floor tile

■ **STYL** / 60,8X60,8 cm

IN & OUT

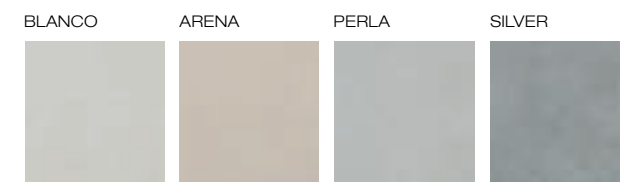

PACKING & SPECIAL PIECES

	Pc/Cj	M2/Cj	Cj/PI	M2/PI	Kg/Cj	Kg/PI
25x70	9	1,58	64	101,12	24,64	1596,96
25x70 Riv	9	1,58	56	88,48	24,64	1399,84
	Cód.		Cód			
Miler	MR150	Rlv Sook	MR155			

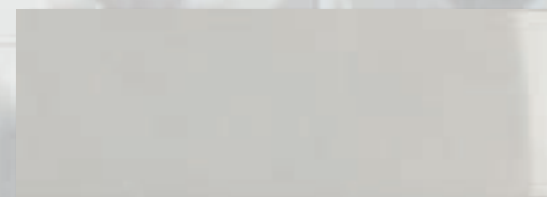

miler blanco



rlv sook arena

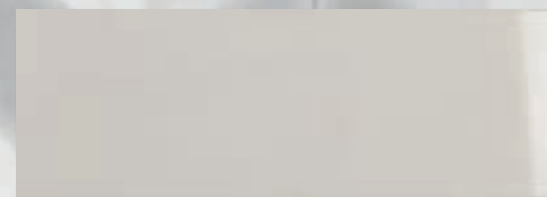

miler arena

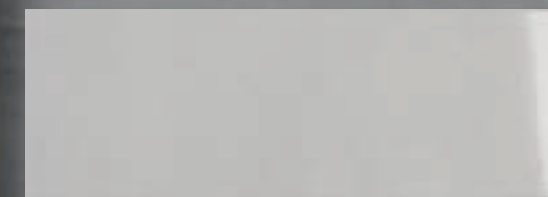

miler perla



rlv sook perla

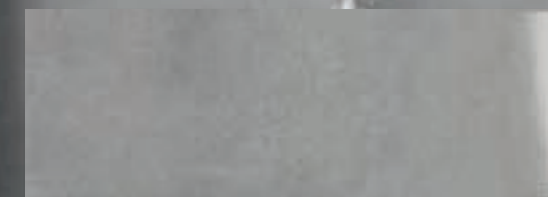

miler silver

Miler silver / Rlv Sook perla 25x70 / 10"x28"

byron



RB



GRUPO BIII

20x60
8"x24"

↓
9,4 mm
↑

PAVIMENTO RECOMENDADO
recommended floor tile

■ **BERLÍN / 45X45 cm**

CREMA



GRIS

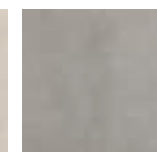

GRAFITO

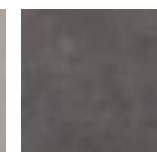

■ **FUSTA / 20X60 cm**

NOGAL

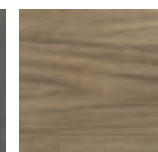

ROBLE



PACKING & SPECIAL PIECES

	Pc/Cj	M2/Cj	Cj/PI	M2/PI	Kg/Cj	Kg/PI
20x60	9	1,08	80	86,4	17,9	1452
	Cód.		Cód			
Byron	MR140	Dc Howe	MR146			



byron gris

dc howe grey

byron grafito

Byron gris / Byron grafito / Dc Howe grey 20x60 / 8"x24"

ateleri



RB



GRUPO BIII

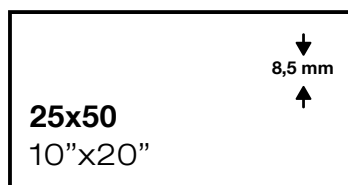

PAVIMENTO RECOMENDADO
recommended floor tile

BERLIN 60,8X60,8 cm



PACKING & SPECIAL PIECES

	Pc/Cj	M2/Cj	Cj/PI	M2/PI	Kg/Cj	Kg/PI
25x50	16	2	48	96	26,5	1292
	Cód.			Cód		
Ateleri	MR110	Rlv Ateleri	MR115			



ateleri gris

rlv ateleri marengo

ateleri marengo

Ateleri gris / Rlv Ateleri marengo 25x50 / 10"x20"



ateleri marfil

rlv ateleri crema

ateleri crema

dafne

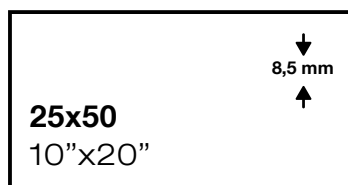

PAVIMENTO COORDINADO
coordinated floor tile

■ RODANO / 60,8X60,8 cm



Dafne marfil / Rlv Tierra natural 25x50 / 10"x20"



dafne perla

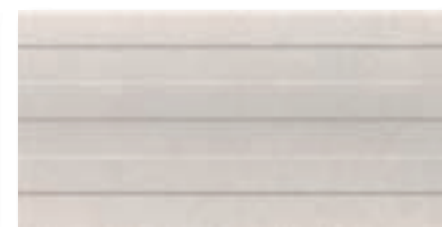

rlv ladon perla



dafne gris

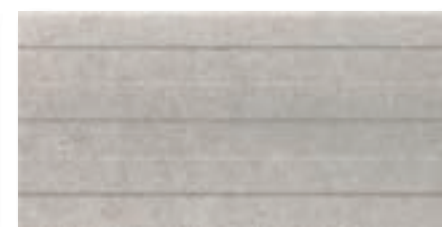

rlv ladon gris

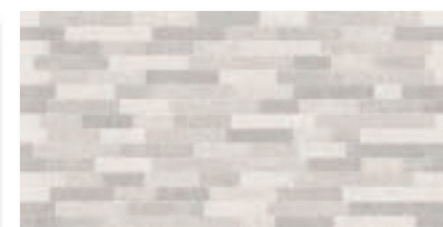

rlv tierra gris



dafne marfil



rlv ladon marfil



dafne natural

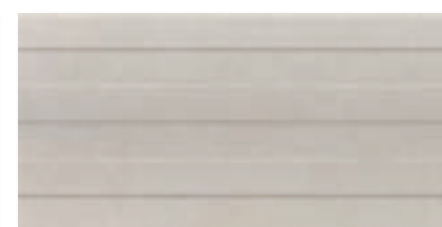

rlv ladon natural



rlv tierra natural

	Pc/Cj	M2/Cj	Cj/Pl	M2/Pl	Kg/Cj	Kg/Pl
25x50	16	2	48	96	26,5	1292

	Cód.
Dafne	MR100
Rlv Ladón / Tierra	MR115

avart

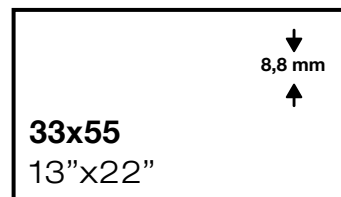

PAVIMENTO COORDINADO
coordinated floor tile

■ **DRAVA** / 60,8X60,8 cm



PACKING & SPECIAL PIECES

	Pc/Cj	M2/Cj	Cj/PI	M2/PI	Kg/Cj	Kg/PI
33x55	10	1,84	48	88,32	28	1364
33x55 Rlv	10	1,84	48	88,32	26,6	1296,8

	Cód.	Cód.	Cód.
Avart	MR100	Rlv Avart	MR105
		Dc Avart	MR106

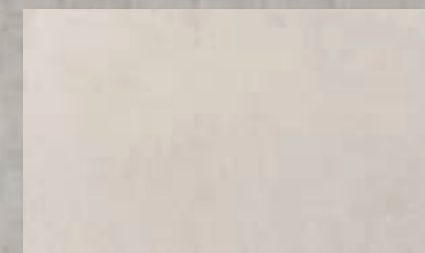

avart marfil



rlv avart marfil

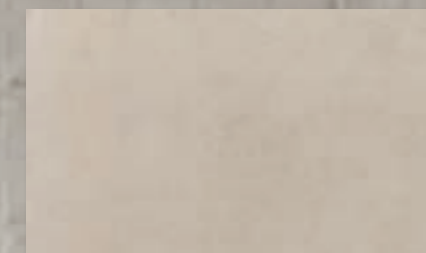

avart arena

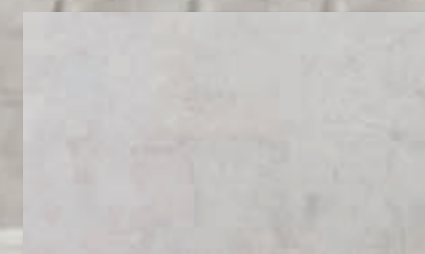

avart perla



rlv avart perla

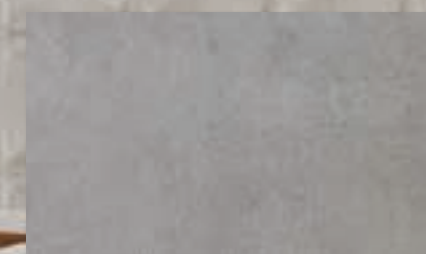

avart silver



dc avart marfil

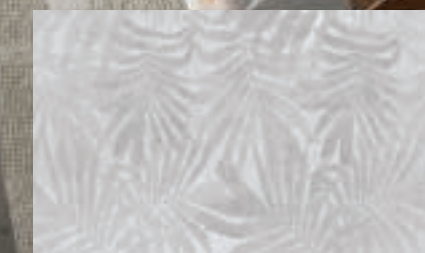

dc avart perla

Avart marfil / Rlv Avart marfil 33x55 / 13"x22"

keon



RB



20x60
8"x24"

9,4 mm

PAVIMENTO COORDINADO
coordinated floor tile

MUTAZ / 60,8X60,8 cm

IN & OUT

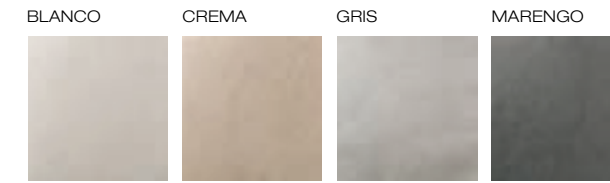

PACKING & SPECIAL PIECES

	Pc/Cj	M2/Cj	Cj/PI	M2/PI	Kg/Cj	Kg/PI
20x60	9	1,08	80	86,4	17,9	1452
	Cód.		Cód		Cód	
Keon	MR140	Rlv Keon	MR145	Rlv Natu	MR145	



keon blanco

rlv natu crema

rlv keon crema

keon crema



Keon crema / Rlv natu crema 20x60 / 8"x24"



keon gris

rlv natu gris

rlv keon gris

keon marengo

rodano



PAVIMENTO COORDINADO coordinated floor tile

■ **RODANO** / 60,8X60,8 cm



PACKING & SPECIAL PIECES

	Pc/Cj	M2/Cj	Cj/PI	M2/PI	Kg/Cj	Kg/PI
25x70	9	1,58	64	101,12	24,64	1596,96
25x70 Riv	9	1,58	56	88,48	24,64	1399,84
	Cód.		Cód		Cód	
Rodano	MR150	Riv Odra	MR155	Dc Volga / Elba	MR156	



rodano marfil

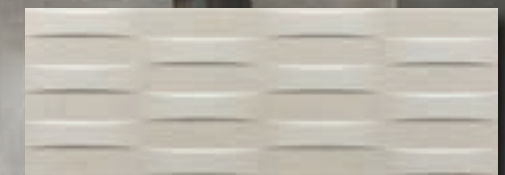

riv odra marfil



rodano natural



riv odra natural



dc volga marfil



rodano perla



riv odra perla



dc elba mix

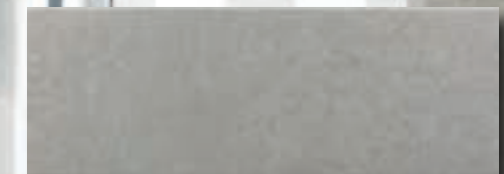

rodano gris



riv odra gris

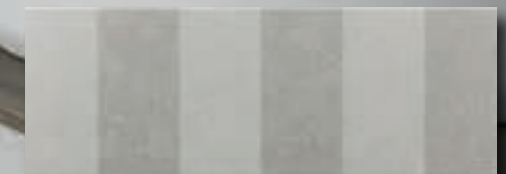

dc volga perla

Rodano perla / Dc Volga perla 25x70 / 10"x28"

artan

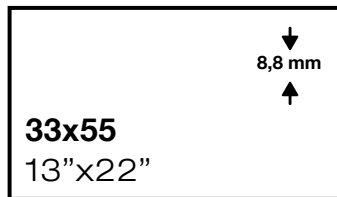

PAVIMENTO RECOMENDADO
recommended floor tile

■ **TIOGA / 20X60 cm**

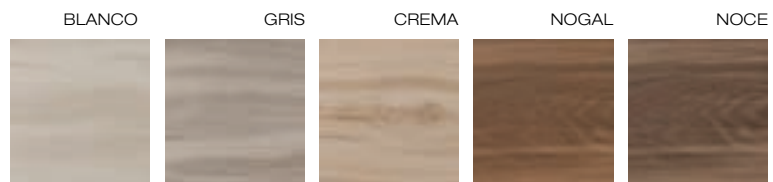

Artan marengo / Rlv Track marengo 33x55 / 13"x22"

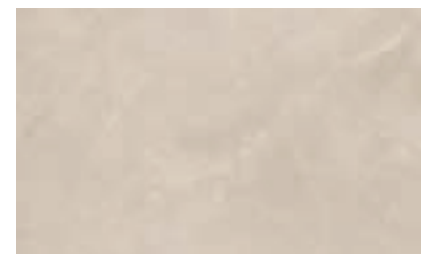

artan crema

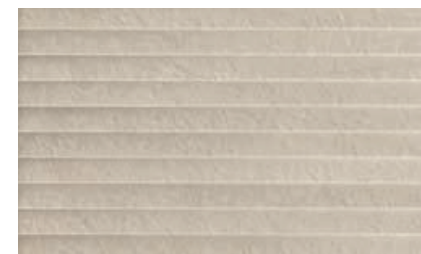

rlv track crema

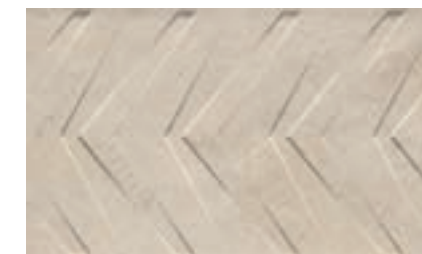

rlv klee crema



artan natural



rlv track natural

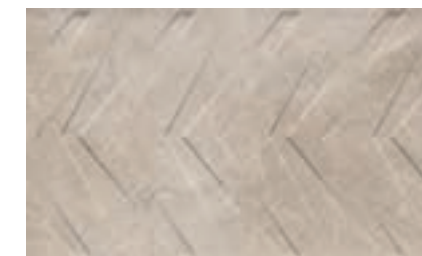

rlv klee natural



artan gris

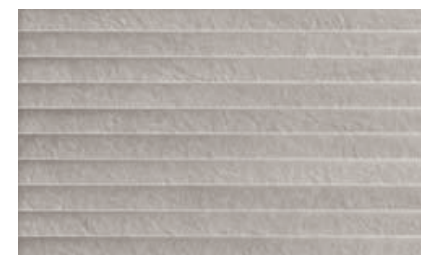

rlv track gris



rlv klee gris



artan marengo



rlv track marengo



rlv klee marengo

	Pc/Cj	M2/Cj	Cj/PI	M2/PI	Kg/Cj	Kg/PI
33x55	10	1,84	48	88,32	28	1364
33x55 Rlv	10	1,84	48	88,32	26,6	1296,8

	Cód.
Artan	MR100
Rlv Klee / Track	MR105

laos



RB



GRUPO BIII

↓
8,5 mm
↑

25x70
10"x28"

PACKING & SPECIAL PIECES

	Pc/Cj	M2/Cj	Cj/PI	M2/PI	Kg/Cj	Kg/PI
25x70	9	1,58	64	101,12	24,64	1596,96
25x70 Riv	9	1,58	56	88,48	24,64	1399,84
	Cód.		Cód			
Laos	MR150	Rlv Luang	MR155			

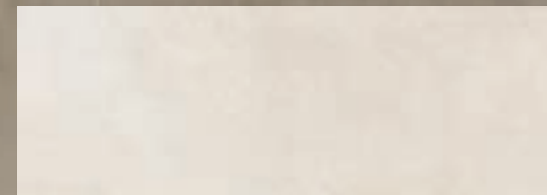

laos marfil

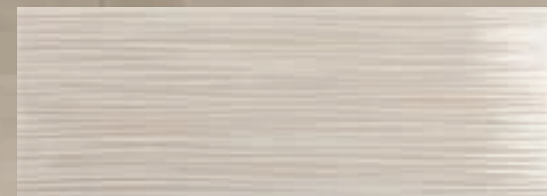

rlv luang marfil

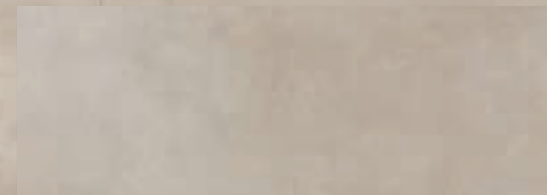

laos noce

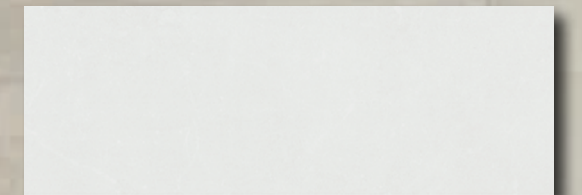

laos blanco



rlv luang perla

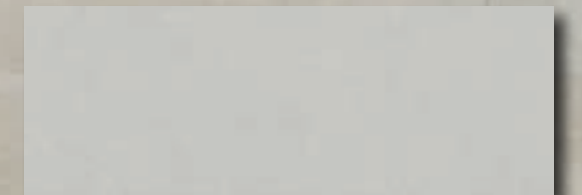

laos perla

Laos noce / Rlv Luang marfil 25x70 / 10"x28"

sener

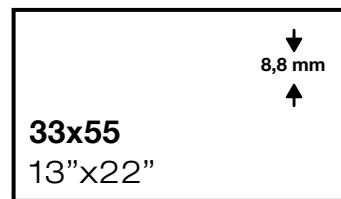

PAVIMENTO COORDINADO
coordinated floor tile

● **RENESS** / 60,8X60,8 cm



PACKING & SPECIAL PIECES

	Pc/Cj	M2/Cj	Cj/PI	M2/PI	Kg/Cj	Kg/PI
33x55	10	1,84	48	88,32	28	1364
33x55 Rlv	10	1,84	48	88,32	26,6	1296,8
	Cód.		Cód.		Cód.	
Sener	MR100	Rlv Sener	MR105	Dc Sener	MR106	

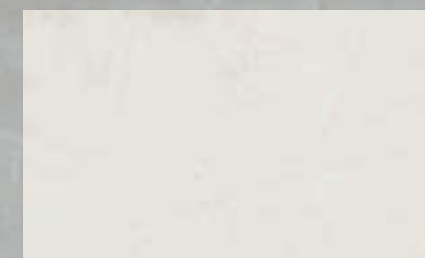

sener crema



rlv sener crema

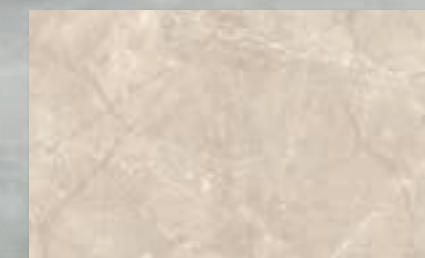

sener gold

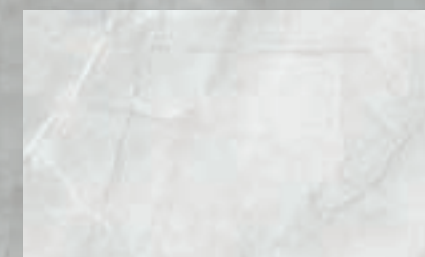

sener perla



rlv sener perla



sener gris



dc sener crema



dc sener gris

Sener perla / Rlv Sener perla 33x55 / 13"x22"

north



RB

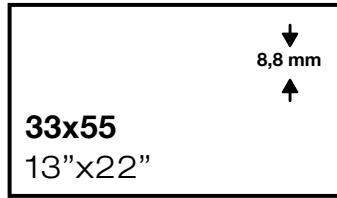

PAVIMENTO RECOMENDADO
recommended floor tile

● **LUANY** / 60,8X60,8 cm



PACKING & SPECIAL PIECES

	Pc/Cj	M2/Cj	Cj/PI	M2/PI	Kg/Cj	Kg/PI
33x55	10	1,84	48	88,32	28	1364
33x55 Riv	10	1,84	48	88,32	26,6	1296,8

	Cód.	Cód.	Cód.
North	MR100	Rlv North	MR105
		Dc North	MR106



North perla / Dc North perla 33x55 / 13''x22''

azur



RB

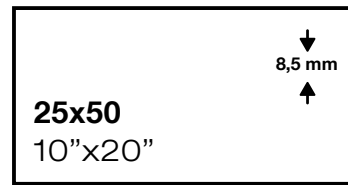

PAVIMENTO COORDINADO
coordinated floor tile

● **FORUM** / 45X45 cm
BLANCO



PIEZAS ESPECIALES
special pieces

AZUR



ZÓCALO OKA
P830 10x25 cm

PACKING & SPECIAL PIECES

	Pc/Cj	M2/Cj	Cj/PI	M2/PI	Kg/Cj	Kg/PI
25x50	16	2	48	96	26,5	1292
	Cód.			Cód		Cód
Azur	MR110	Dc Azur	MR116	Dc Azur Vent.	MR116	MR116



Azur / Dc Azur 25x50 / 10"x20"

calacatta

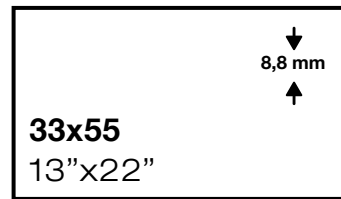

PAVIMENTO RECOMENDADO
recommended floor tile

■ **TIOGA / 20X60 cm**

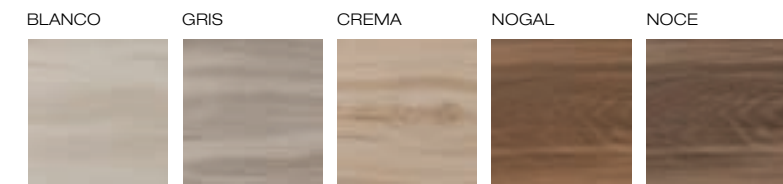

PACKING & SPECIAL PIECES

	Pc/Cj	M2/Cj	Cj/PI	M2/PI	Kg/Cj	Kg/PI
33x55	10	1,84	48	88,32	28	1364
33x55 Rlv	10	1,84	48	88,32	26,6	1296,8
	Cód.			Cód.		
Calacatta	MR100	Rlv Linee / Calacatta		MR105		

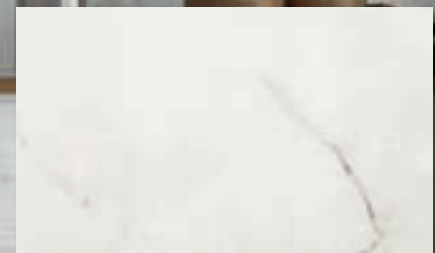

calacatta white matt



rlv linee white matt

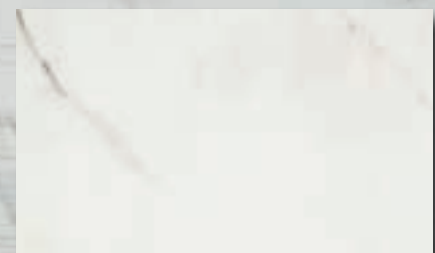

calacatta white gloss



rlv linee white gloss



rlv calacatta white gloss

Calacatta white matt / Rlv Linee white matt 33x55 / 13"x22"

lengo

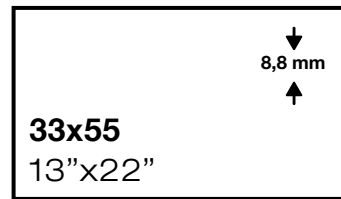

PACKING & SPECIAL PIECES

	Pc/Cj	M2/Cj	Cj/PI	M2/PI	Kg/Cj	Kg/PI
33x55	10	1,84	48	88,32	28	1364
33x55 Riv	10	1,84	48	88,32	26,6	1296,8

	Cód.		Cód.		Cód.
Lengo	MR100	Rlv Lengo / Legua	MR105	Dc Lengo	MR106

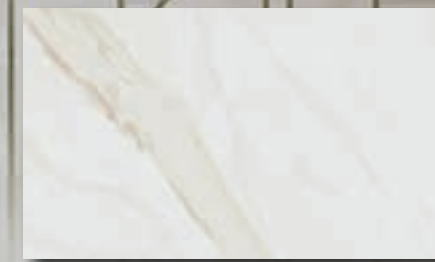

lengo white



rlv lengo white



dc lengo

Dc Lengo 33x55 / 13"x22"



gualdo



RB

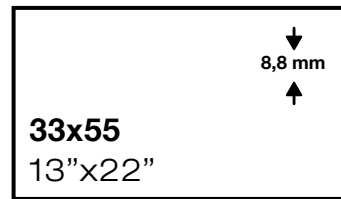

PACKING & SPECIAL PIECES

	Pc/Cj	M2/Cj	Cj/PI	M2/PI	Kg/Cj	Kg/PI
33x55	10	1,84	48	88,32	28	1364
33x55 Riv	10	1,84	48	88,32	26,6	1296,8
	Cód.		Cód.			
Gualdo	MR100	Riv Gualdo / Legua	MR105			

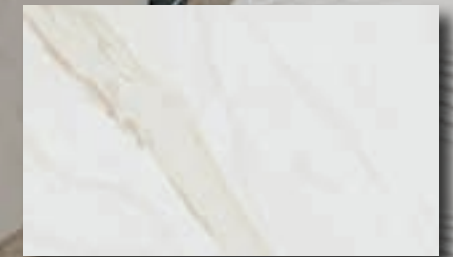

gualdo white



riv gualdo white



riv legua white matt

Riv Gualdo white 33x55 / 13"x22"

marblebrick

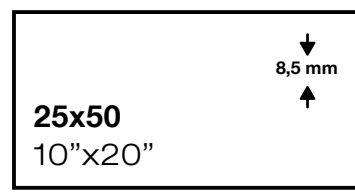

PAVIMENTO RECOMENDADO
recommended floor tile

■ **TIOGA** / 20X60 cm

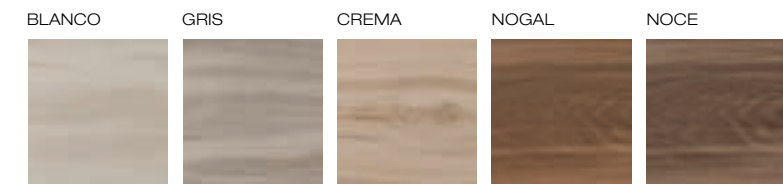

PACKING & SPECIAL PIECES

	Pc/Cj	M2/Cj	Cj/PI	M2/PI	Kg/Cj	Kg/PI
25x50	14	1,75	48	84	25,8	1258,4
	Cód.					
Marblebrick	MR120					



marblebrick blanco

marblebrick brown

marblebrick perla

marblebrick mix

Marblebrick blanco 25x50 / 10"x20"

flat



30x90
12"x36"

↓
8,5 mm
↑

PACKING & SPECIAL PIECES

PAVIMENTO RECOMENDADO
recommended floor tile



	Pc/Cj	M2/Cj	Cj/PI	M2/PI	Kg/Cj	Kg/PI
30x90	7	1,9	48	91,2	30,5	1479,7
	Cód.		Cód.		Cód.	
Flat	MR160	Cerro	MR165	Lake	MR165	

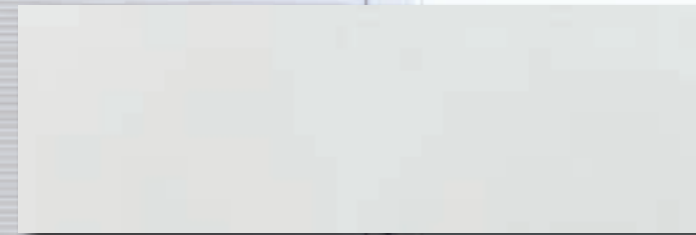

flat blanco brillo

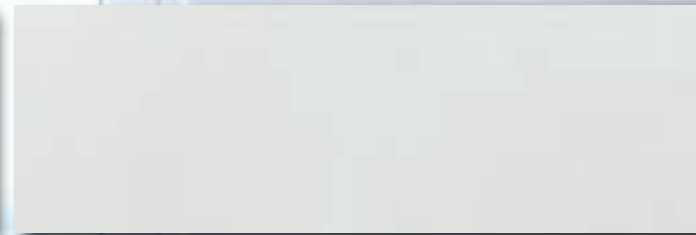

flat blanco mate



lake brillo

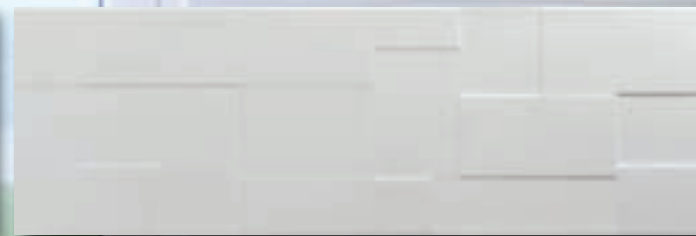

cerro brillo

Flat blanco / Lake brillo 30x90 / 12"x36"

flat



25x70
10"x28"

↓
8,5 mm
↑

PAVIMENTO RECOMENDADO

recommended floor tile

■ **TIOGA** / 20X60 cm

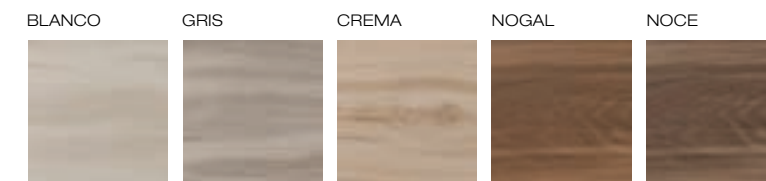

PACKING & SPECIAL PIECES

	Pc/Cj	M2/Cj	Cj/PI	M2/PI	Kg/Cj	Kg/PI
25x70	9	1,58	64	101,12	24,64	1596,96
25x70 Riv	9	1,58	56	88,48	24,64	1399,84
	Cód.		Cód		Cód	
Flat	MR150	Ondas	MR155	Liner	MR155	

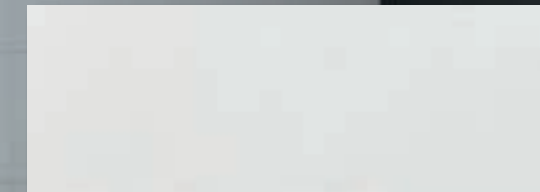
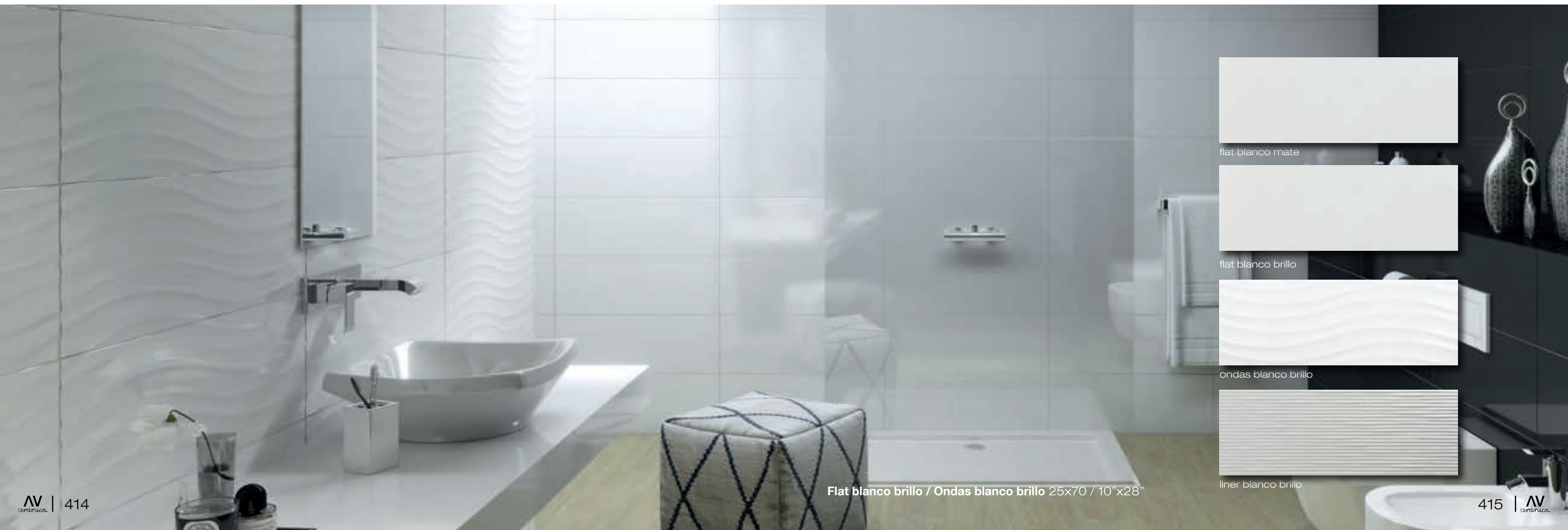

flat blanco mate

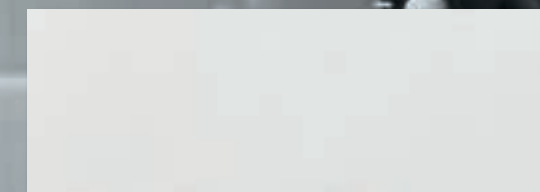

flat blanco brillo

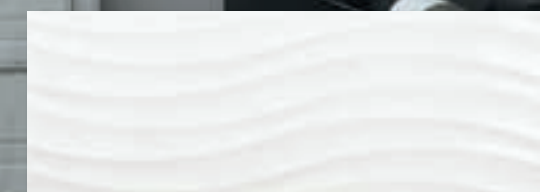

ondas blanco brillo



liner blanco brillo

Flat blanco brillo / Ondas blanco brillo 25x70 / 10"x28"

blancos



PACKING & SPECIAL PIECES

	Pc/Cj	M2/Cj	Cj/PI	M2/PI	Kg/Cj	Kg/PI
25x50	16	2	48	96	26,5	1292
20x60	9	1,08	80	86,4	21,08	1706,4
25x70	9	1,58	64	101,12	24,64	1596,9
30x60	8	1,44	60	46,08	22,5	740
30x90	7	1,9	48	91,2	30,5	1479,7

PASTA ROJA / RED BODY	Cód.
Fresh mate 25x50	MR110
Next White / Mate 20x60	MR140
Flat Blanco / Mate 25x70	MR150
Flat Brillo / Mate 30x90	MR160
Blanco Brillo / Mate 31,6x60	MR130
Blanco Brillo / Mate 33,3x55	MR100

	Pc/Cj	M2/Cj	Cj/PI	M2/PI	Kg/Cj	Kg/PI
36x80	4	1,15	54	62,1	19,2	1056,8
31,6X60	8	1,52	48	72,96	26	1268
33,3X55	10	1,84	48	88,32	28	1364
33X100	6	2	48	96	24	1174

PASTA BLANCA / WHITE BODY	Cód.
Annie / Timisoara 30x90	MB140
Blanco Brillo / Mate 30x60	MB130
Sandra Mate 36x80	MB120
Terranova Brillo 36x80	MB120
Daffen / Ethan 33,3x100	MB150

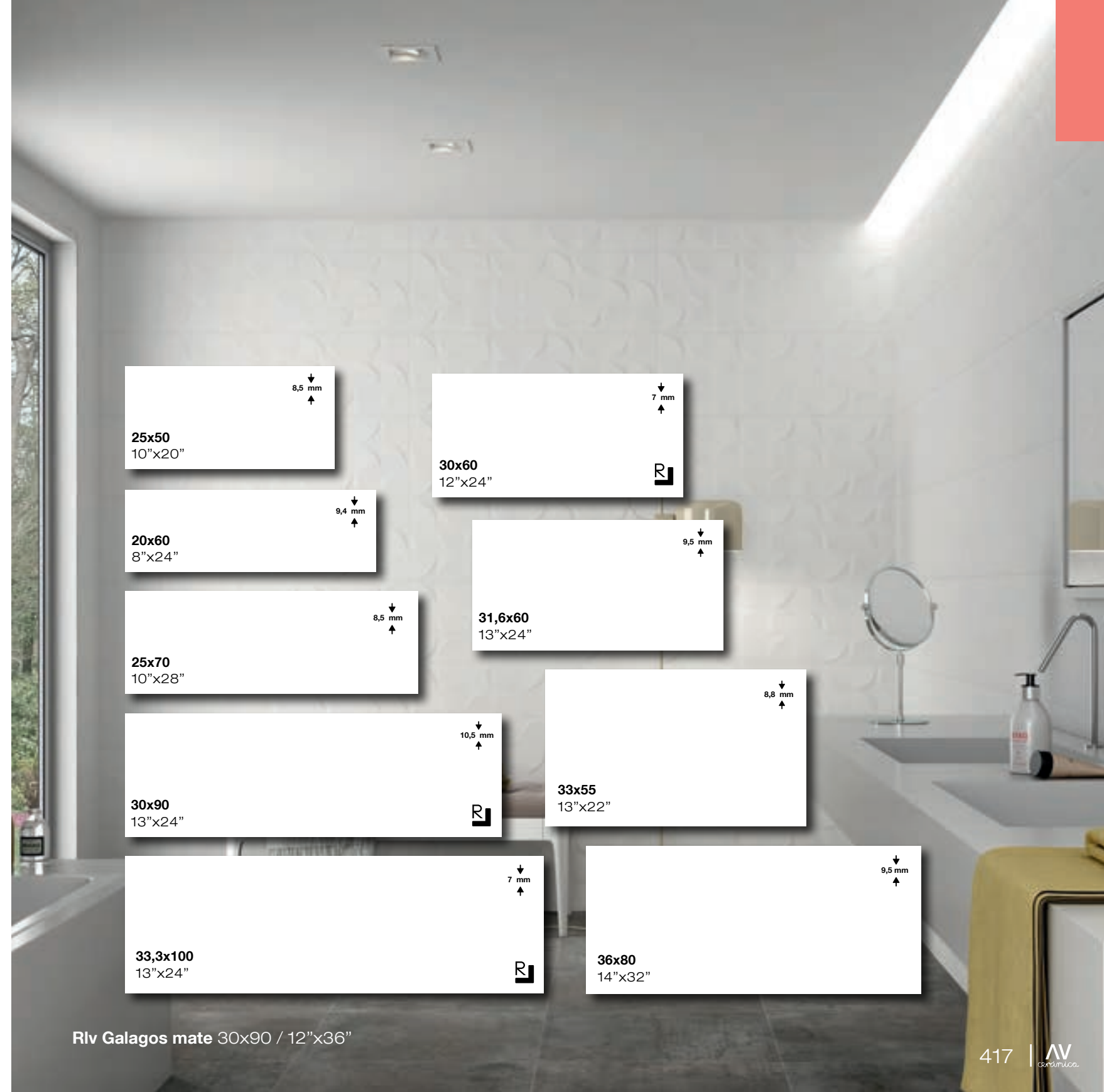

Riv Galagos mate 30x90 / 12"x36"



ÁREA TÉCNICA
TECHNICAL AREA
DOMAINE TECHNIQUE
TECHNISCHER BEREICH

Soluciones Técnicas Technical Solutions

La adherencia entre la pieza y el soporte junto con una buena colocación juegan un papel imprescindible en la vida útil de la cerámica. El avance de las tecnologías ha dado lugar a una nueva era debido a la mejora en las propiedades de la cerámica, tales como la disminución de la porosidad, la alta resistencia a la abrasión y al hielo y la creación de grandes formatos y acabados de ensueño.

Dicha evolución cerámica da lugar al avance de los adhesivos, pasando de una adherencia mecánica, en el que se necesita una gruesa capa de material, frente a la adherencia química actual, la cual, a parte de reducir la cantidad de material a utilizar, mejora la adherencia y por consiguiente su durabilidad.

Algunas recomendaciones para garantizar la correcta colocación de la baldosa cerámica son utilizar herramientas y útiles adecuados, tales como llana dentada, maza de goma blanca, nivel de burbuja y ventosa. La instalación será siempre con doble encolado, junta mínima de 2 mm, excepto espesados, que dejaremos una junta mínima de 5 mm. No utilizaremos productos que contengan negro de humo o carbón micronizado. Como también, una buena limpieza del soporte para eliminar cualquier resto de yeso o pintura, utilizando siempre limpiadores finalizadores de obra, que no contengan ácido fluorhídrico. A parte de considerar siempre las indicaciones del fabricante.

The adhesion between the piece and the support together with a good placement play an essential role in the useful life of the ceramic. The advancement of technologies has given rise to a new era due to the improvement in the properties of ceramics, such as reduced porosity, high resistance to abrasion and ice and the creation of large formats and dream finishes. .

This ceramic evolution gives rise to the advancement of adhesives, moving from a mechanical adherence, in which a thick layer of material is needed, compared to current chemical adherence, which, apart from reducing the amount of material to be used, improves adherence and consequently its durability.

Some recommendations to guarantee the correct placement of the ceramic tile are to use suitable tools and tools, such as notched trowel, white rubber mallet, spirit level and suction cup. As well as a good cleaning of the support to remove any remaining plaster, painting etc. Apart from always considering the manufacturer's indications.

Recomendaciones de colocación y limpieza Placement and cleaning recommendations

grandes formatos
big sizes



formato 33x100
33x100 size



limpieza
cleaning



Certificación Certification

Nuestra constante inquietud por avanzar y satisfacer las necesidades más exigentes del mercado, nos permite tener un producto cerámico de calidad con un diseño de última tendencia. Este compromiso se ha visto reconocido por los distintos certificados de calidad. Alcanzamos con creces los requisitos que nos convierten en una empresa certificada ISO 9001:2015 en el diseño, producción y distribución de nuestras colecciones cerámicas. Disponemos de un sistema productivo basado en la calidad de nuestros productos y la confianza de nuestros clientes.

Our constant concern to advance and satisfy the most demanding needs of the market, allows us to have a quality ceramic product with a cutting-edge design. This commitment has been recognized by the various quality certificates. We more than reach the requirements that make us an ISO 9001: 2015 certified company in the design, production and distribution of our ceramic collections. We have a production system based on the quality of our products and the trust of our customers.



Descarga nuestros certificados aquí.



ISO 14021:2016



Modelos UPEC UPEC series

El sello UPEC es un certificado francés expedido por el Centre Scientifique du Bâtiment (CSTB), el cual garantiza la seguridad y calidad de los productos cerámicos de Navarti conforme a unas especificaciones técnicas concretas. Para la obtención de este sello, clasificado dentro del certificado NF, los materiales de Navarti han sido sometidos a unos rigurosos controles de calidad. Cada sigla de la palabra UPEC hace referencia a un rasgo específico del material:

- U** - resistencia al desgaste
- P** - resistencia a la perforación o rotura
- E** - resistencia a la humedad y al agua
- C** - resistencia a los agentes químicos



The UPEC seal is a French certificate issued by the Centre Scientifique du Bâtiment (CSTB), which guarantees the safety and quality of Navarti ceramic products according to specific technical specifications. To obtain this seal, classified within the NF certificate, Navarti materials have been subjected to rigorous quality controls. Each acronym of the word UPEC refers to a specific feature of the material:

- U - wear resistance
- P - resistance to puncture or breakage
- E - resistance to moisture and water
- C - resistance to chemical agents

SERIE ANTIBES / ANTIBES SERIES

PÁG. 310

FORMATO	ESPESOR	PECULIARIDAD	COLORES	CLASIFICACIÓN
45X45	9,5 mm	-	dark grey	U4 P4 E3 C2
45X45	9,5 mm	-	grey	U4 P4 E3 C2
45X45	9,5 mm	-	ivory	U4 P4 E3 C2
45X45	9,5 mm	-	pearl	U4 P4 E3 C2
60X60	9,5 mm	rectificado	dark grey	U4 P3 E3 C2
60X60	9,5 mm	rectificado	grey	U4 P3 E3 C2
60X60	9,5 mm	rectificado	ivory	U4 P3 E3 C2
60X60	9,5 mm	rectificado	pearl	U4 P3 E3 C2

SERIE ZIRO / ZIRO SERIES

PÁG. 310

FORMATO	ESPESOR	PECULIARIDAD	COLORES	CLASIFICACIÓN
45X45	9,5 mm	-	blanco	U4 P4 E3 C2
45X45	9,5 mm	-	crema	U4 P4 E3 C2
45X45	9,5 mm	-	gris	U4 P4 E3 C2
45X45	9,5 mm	-	marengo	U4 P4 E3 C2
45X45	9,5 mm	-	perla	U4 P4 E3 C2
60X60	9,5 mm	rectificado	blanco	U4 P3 E3 C2
60X60	9,5 mm	rectificado	crema	U4 P3 E3 C2
60X60	9,5 mm	rectificado	gris	U4 P3 E3 C2
60X60	9,5 mm	rectificado	marengo	U4 P3 E3 C2
60x60	9,5 mm	rectificado	perla	U4 P3 E3 C2

SERIE SOUTHROCK / SOUTHROCK SERIES

PÁG. 310

FORMATO	ESPESOR	PECULIARIDAD	COLORES	CLASIFICACIÓN
45X45	9,5 mm	-	gris	U2S P3 E3 C2
45X45	9,5 mm	-	marengo	U2 P3 E3 C2
45X45	9,5 mm	-	perla	U3 P3 E3 C2

SERIE BERLÍN / BERLIN SERIES

PÁG. 310

FORMATO	ESPESOR	PECULIARIDAD	COLORES	CLASIFICACIÓN
45X45	9,5 mm	-	gris	U2S P3 E3 C2
45X45	9,5 mm	-	perla	U2S P3 E3 C2
60,8x60,8	9,5 mm	-	gris	U2S P3 E3 C2
60,8x60,8	9,5 mm	-	perla	U2S P3 E3 C2

Modelos IN & OUT IN & OUT series

SERIE	FORMATO	ESPESOR	NAT	COLORES	PÁG.
MUTAZ	30,3X61,3	9 mm	CLASE 3	blanco / crema / gris / marengo	284
STYL	30,3X61,3	9 mm	CLASE 3	blanco / arena / perla / silver	264
RLV ELYT (STYL)	30,3X61,3	9 mm	CLASE 3	blanco / arena / perla / silver	264
TOWNS	30,3X61,3	9 mm	CLASE 3	white / taupe / pearl / gris	282
RLV NIMES (TOWNS)	30,3X61,3	9 mm	CLASE 3	white / taupe / pearl / gris	282

SERIE	FORMATO	ESPESOR	NAT	COLORES	PÁG.
AMYP	60,8X60,8	9,5 mm	CLASE 3	ivory / musgo / antracita	288
MUTAZ	60,8X60,8	9,5 mm	CLASE 3	blanco / crema / gris / marengo	284
STYL	60,8X60,8	9,5 mm	CLASE 3	blanco / arena / perla / silver	264
TOWNS	60,8X60,8	9,5 mm	CLASE 3	white / taupe / pearl / gris	282



AMYP ANTRACITA 60,8x60,8 / 24"x24"

Rlv & Dc index

- White Body Wall Tile / Pasta Blanca
- Glazed Porcelain / Porcelánico Esmaltado
- Technical Porcelain / Porcelánico Técnico
- Red Body Wall Tile / Revestimiento Pasta Roja
- Polished Porcelain / Porcelánico Pulido

		33,3x100cm / 13"x24"	60x60 / 24"x24"	30x90cm / 11,8"x35,4"	36x80cm / 14"x31,2"	25x70cm / 9,8"x27,5"	30x60cm / 11,8"x23,6"	20x60cm / 7,9"x23,6"	33x55cm / 13"x21,6"	25x50cm / 9,8"x19,7"	60X120 / 24"x48"
Annie	Rlv Galagos		352								
Artan	Rlv Track									394	
	Rlv Klee										
Avart	Rlv Avart									388	
	Dc Avart										
Azur	Dc Azur										402
	Dc Azur Vent.										
Bellagio	Rlv Bellagio		344								
Bethel	Necker		376								
	Newhalen										
Byron	Dc Howe							382			
Calacatta	Rlv Calacatta									382	
	Rlv Linee										
Carra	Rlv Carra		346								
Ceres	Rlv Hoyo		342								
Daffen	Rlv Ted		354								
	Rlv Hanne										
Dafne	Rlv Ladon										386
	Dc Tierra										
Drava	Rlv Upa										
	Rlv Don		346								
	Dc Saale										
Elder	Dc Tinsel										120
Ethan	Rlv Ted		354								
	Rlv Hanne										
Flat	Ondas									414	
	Liner										
	Lake									412	
Cerro	Rlv Gualdo										408
	Rlv Legua										
Iris	Dc Canvas										
	Rlv Icon		350								
Kamen	Rlv Name										
	Rlv Bilice		338								
	Dc Lovret										
Keon	Rlv Natu										390
	Rlv Keon										

		33,3x100cm / 13"x24"	60x60 / 24"x24"	30x90cm / 11,8"x35,4"	36x80cm / 14"x31,2"	25x70cm / 9,8"x27,5"	30,3x61,3cm / 11,8"x23,6"	20x60cm / 7,9"x23,6"	33x55cm / 13"x21,6"	25x50cm / 9,8"x19,7"	60X120 / 24"x48"
Laos	Rlv Luang										396
Lengo	Rlv Lengo										406
	Dc Lengo										
Lithos	Rlv Tye			324							
Manhattan	Dc Tinsel										258
	Rlv Manhattan			316							
Miller	Rlv Sook							380			
Native	Dc Indio			348							
Nature	Rlv Nature			336							
North	Rlv North Mix										400
	Dc North										
	Rlv Odra										
Rodano	Dc Volga										392
	Dc Elba										
Sandra	Rlv Sandra										356
	Rlv Noon										
Sener	Rlv Sener										398
	Dc Sener										
Serene	Rlv Serene			318							
Stuc	Rlv Flavia										378
	Rlv Smart										
	Dc Link										
Styl	Rlv Elyt										264
Terranova	Rlv Terranova										356
	Rlv Indoc										
Timisoara	Rlv Galagos			352							
Towns	Rlv Nimes										282
Ziro	Rlv Kata										332
	Dc Bree										
	Dc Ergo										
	Dc Tinsel										

RLV CERES ÓXIDO 30x90 / 12"x36"





PELDAÑO INCISIÓN ZIRO / INCISION STEP



PELDAÑO GRADONE ZIRO / GRADONE STEP



RODAPIÉ ROMO ZIRO / SKIRTING

Piezas especiales por tipología de producto · Special pieces by product type

PAVIMENTO PASTA ROJA / RED BODY FLOOR TILES

Producto	20X60 (7,4x60)	45X45 (7,4x45)	45x90 (9X90)
RODAPIÉ ROMO	P645	P650	P655

PAVIMENTO PORCELÁNICO PULIDO _ GRANILLA PULIDA _ POLIMAT _ SUGAR LAPPATO
POLISHED PORCELAIN FLOOR TILE _ HIGHLY POLISHED _ POLIMAT _ SUGAR LAPPATO

Producto	60X120 (30X120)	120X120 (30X120)	90x180 (30x180)	75X75
PELDAÑO GRADONE	P325	P330	P350	P335
	60X60 / 30X60	90x90 (30x90)	75x150 (30x150)	
	P340	P345	P355	
Producto	60X120 (30X120)	120X120 (30X120)	90x180 (30x180)	75X75
ÁNGULO GRADONE	P360	P365	P405	P370
	60X60 / 30X60	90x90 (30x90)	75x150 (30x150)	
	P375	P400	P410	
Producto	60X120 (30X120)	120X120 (30X120)	90x180 (30x180)	75X75
PELDAÑO	P415	P420	P440	P425
	60X60 / 30X60	90x90 (30x90)	75x150 (30x150)	
	P430	P435	P445	
Producto	60X120 (30X120)	120X120 (30X120)	90x180 (30x180)	75X75
ÁNGULO ROMO	P450	P455	P475	P460
	60X60 / 30X60	90x90 (30x90)	75x150 (30x150)	
	P465	P470	P480	

PAVIMENTO PORCELÁNICO ESMALTADO / GLAZED PORCELAIN FLOOR TILE

Producto	60X120 (30X120)	120X120 (30X120)	45x90 (30X90)	75X75
PELDAÑO GRADONE	P010	P015	P020	P030
	60X60 / 30X60 / 30,3X61,3 / 60,8X60,8 (30X60)		20X120 (20X120)	90X180 (30X180)
	P035		P040	P045
	45X45 (30X45)	90X90 (30X90)	25X100 (25X100)	25X150 (25X150)
	P025	P050	P055	P060
	75X150 (30X150)	20X75 (20X75)	23X120 (23X120)	
	P085	P090	P095	
Producto	60X120 (30X120)	120X120 (30X120)	45x90 (30X90)	75X75
ÁNGULO GRADONE	P100	P105	P110	P120
	60X60 / 30X60 / 30,3X61,3 / 60,8X60,8 (30X60)		20X120 (20X120)	90X180 (30X180)
	P125		P130	P140
	45X45 (30X45)	90X90 (30X90)	25X100 (25X100)	25X150 (25X150)
	P115	P170	P140	P145
	75X150 (30X150)	20X75 (20X75)	23X120 (23X120)	
	P165	P175	P180	

Producto	60X120 (30X120)	120X120 (30X120)	45x90 (30X90)	75X75
PELDAÑO ROMO	P185	P190	P195	P205
	60X60 / 30X60 / 30,3X61,3 / 60,8X60,8 (30X60)		20X120 (20X120)	90X180 (30X180)
	P210		P215	P220
	45X45 (30X45)	90X90 (30X90)	25X100 (25X100)	25X150 (25X150)
	P200	P225	P230	P235
	75X150 (30X150)	20X75 (20X75)	23X120 (23X120)	
	P240	P245	P250	
Producto	60X120 (30X120)	120X120 (30X120)	45x90 (30X90)	75X75
ÁNGULO ROMO	P255	P260	P265	P275
	60X60 / 30X60 / 30,3X61,3 / 60,8X60,8 (30X60)		20X120 (20X120)	90X180 (30X180)
	P280		P285	P290
	45X45 (30X45)	90X90 (30X90)	25X100 (25X100)	25X150 (25X150)
	P270	P295	P300	P305
	75X150 (30X150)	20X75 (20X75)	23X120 (23X120)	
	P310	P315	P320	

RODAPIE ROMO PORCELÁNICO PULIDO / POLISHED PORCELAIN ROMO SKIRTING

60X60 / 30X60 (9X60)	75X75	90X90 / 45X90 (9X90)	120X120 / 60X120 (9X120)	75X150 (8X150)
P595	P600	P605	P610	P615

RODAPIE ROMO PORCELÁNICO / PORCELAIN ROMO SKIRTING

75X150 (8X150)	25X150 (8X150)	25X100 (8X100)	23X120 (9X120)	20X75 (9X75)
P485	P490	P495	P500	P505
120X120 / 60X120 / 20X120 (9X120)	90X90 / 45X90 (9X90)	75X75 (9X75)	45X45 (9X45)	
P510	P515	P520	P530	
60X60 / 30X60 / 30,3X61,3 (9X60 / 61,3)	33,3X33,3 (8X33,3)			
P525	P535			

PELDAÑO EXTRUSIONADO ANGULAR / ANGLE EXTRUDED STEP

PRODUCTO	32X120
PELDAÑO EXTRUSIONADO BOLZANO NATURAL, GREY Y HAYA	P061
PRODUCTO	33,3X33,3
PELDAÑO EXTRUSIONADO BELGRAVIA GREY, BEIGE Y PEARL	P141



PELDAÑO GRADONE METHOD BONE

packing list

PAVIMENTO PASTA ROJA / RED BODY FLOOR TILES

FORMATO	PZ / CJ	M2 / CJ	CJ/PL	M2/PL	KG/CJ	KG/PL
20x60	9	1,08	80	86,4	21,08	1706,4
31x31	16	1,6	54	86,4	28,2	1542,8
45x45	7	1,42	52	73,84	26	1372

REVESTIMIENTO PASTA ROJA / RED BODY WALL TILES

FORMATO	PZ / CJ	M2 / CJ	CJ/PL	M2/PL	KG/CJ	KG/PL
20x60	9	1,08	80	86,4	17,9	1452
25x50	16	2	48	96	26,5	1292
25x50 PIEDRAS	14	1,75	64	112	23,3	1511,2
25x50 RLV	12	1,5	48	72	22,5	1100
25x70	9	1,58	64	101,12	24,64	1596,96
30x90	5	1,35	48	64,8	27,8	1354,4
30x90 RLV	6	1,62	48	77,76	28,8	1402,4
31,6x60	8	1,52	48	72,96	26	1268
33,3x55	10	1,84	48	88,32	28	1364
33,3x55 RLV	10	1,84	48	88,32	26,6	1296,8
34x50	9	1,5	48	72	24,7	1205,6

PORCELÁNICO PASTA ROJA / PORCELAIN RED BODY

FORMATO	PZ / CJ	M2 / CJ	CJ/PL	M2/PL	KG/CJ	KG/PL
31,2x31,2	12	1,17	51	59,67	26	1346

REVESTIMIENTO PASTA BLANCA / WHITE BODY WALL TILES

FORMATO	PZ / CJ	M2 / CJ	CJ/PL	M2/PL	KG/CJ	KG/PL
20x60	9	1,08	64	69,12	17,9	1165,6
25x50	14	1,75	48	84	24,75	1208
25x75 (ARG)	1	1,31	48	62,88	21	1028
30,3x60,5	7	1,28	60	76,8	20,6	1256
36x80	4	1,15	54	62,1	18,5	1019
7,5x30 Rvto	25	0,56	121	67,76	9	1109









REVESTIMIENTO PASTA BLANCA RECTIFICADA / RECTIFIED WHITE BODY WALL TILES

FORMATO	PZ / CJ	M2 / CJ	CJ/PL	M2/PL	KG/CJ	KG/PL
30x60	8	1,44	32	46,08	24,3	797,6
30x60 (F)	9	1,62	72	116,64	20	1460
30x90	4	1,08	64	69,12	18,75	1220
33,3x100	6	2	48	96	24	1172
33,3x100 RLV	5	1,67	48	80,16	25	1220
40x120 (ARG)	3	1,44	20	28,8	25,5	530









PORCELÁNICO / PORCELAIN TILES

FORMATO	PZ / CJ	M2 / CJ	CJ/PL	M2/PL	KG/CJ	KG/PL
120x120	1	1,44	36	51,84	35	1300
120x120 (CONT 40")	1	1,44	36	51,84	38,4	1402,4
15x90	9	1,21	45	54,45	27,6	1262
16.3x51.7	9	0,76	55	41,8	20	1120
17x52	10	0,89	55	48,95	21,4	1197
17x52 (F)	17	1,5	55	82,5	21,75	1216,25
20x120	6	1,44	44	63,36	32	1428
20x120 (F)	7	1,68	44	73,92	32	1428
20x75	7	1,05	72	75,6	18,4	1344,8
22,3x22,3	20	1	45	45	22,5	1032,5
22,5x180	3	1,21	40	48,4	34	1380
23x120	5	1,38	45	62,1	21,4	1433,9
25.8x29 HEXAGON	18	1	48	48	22,5	1100
25x100	6	1,5	36	54	28,5	1046
25x150	4	1,5	40	60	35	1420
30,3x61,3	7	1,3	40	52	26	1060
30x180	3	1,62	30	48,6	45	1370
30x60	7	1,26	40	50,4	24,1	984
30x60 (C)	6	1,08	48	51,84	22	1076
45x45	6	1,22	52	63,44	25,2	1330,4
45x45 (F)	7	1,42	52	73,84	26,13	1378,76
45x45 (RECTIF.)	6	1,22	52	63,44	26,3	1387,6
45x90	3	1,21	44	53,24	28,7	1282,8
60,5x60,5(20mm)	2	0,73	30	21,9	32,8	1004
60,8x60,8	4	1,48	30	44,4	31	950
60,8x60,8 (F)	5	1,85	30	55,5	33,5	1025
60x120	2	1,44	32	46,08	34	1108
60x120 (F)	2	1,44	36	51,84	27,7	1017,2
60x120 (20mm)	1	0,72	32	23,04	34,5	1124
60x60	4	1,44	30	43,2	30,2	926
60x60 (F)	5	1,8	30	54	31	950
61x61(20mm)	2	0,74	30	22,2	33	1010
75,5x75,5(20mm)	1	0,57	45	25,65	27,1	1239,5
75x150	1	1,13	40	45,2	28	1140
75x75	3	1,69	30	50,7	41,2	1256
76x76 (20mm)	1	0,58	45	26,1	27,35	1250,75
90x180	1	1,62	24	38,88	45,5	1112
90x90	2	1,62	27	43,74	42	1154



















CARACTERÍSTICAS TÉCNICAS REVESTIMIENTO MONOPOROSA / TECHNICAL FEATURES FOR MONOPOROSA WALL TILES











	GRUPO BIII (GL) Absorción de agua > 10% GROUP BIII (GL) Water absorption > 10%	NORMAS DE ENSAYO STANDARD	VALORES PRESCRITOS NORMA EN 14411 / VALUE REQUIRED BY EN 14411 STANDARD	VALOR MEDIO AVERAGE VALUE
	Características dimensionales Dimensional features	ISO 10545-2		Cumple la norma Conforms to standard
	Absorción de agua Water absorption	ISO 10545-3	> 10%	16%
	Resistencia a la flexión Modulus of rupture Fuerza de rotura Breaking strength	ISO 10545-4	> 15 N / mm2 > 600 N	15 - 25 N / mm2 400 N
	Resistencia a la abrasión superficial Resistance to surface abrasion	ISO 10545-7	Clase indicada por el fabricante Abrasion class indicated by the manufacturer /	No aplica Not apply
	Dilatación térmica lineal Linear thermal expansion	ISO 10545-8	Método de ensayo disponible Test method available	<7,0 x 10-6 °C-1
	Resistencia al choque térmico Thermal shock resistance	ISO 10545-9	Método de ensayo disponible Test method available	Resiste Resists
	Resistencia al cuarteo Crazing resistance / Résistance au tressaillage	ISO 10545-11	Exigida Required Exigée	Resiste Resists Résiste
	Resistencia química Chemical resistance	ISO 10545-13	Método de ensayo disponible Test method available Mínimo GB Minimum GB	Cumple la norma Conforms to standard Clase GA Class GA
	Resistencia a las manchas Resistance to stains	ISO 10545-14	Mínimo clase 3 Minimum class 3	Cumple la norma Conforms to standard

CARACTERÍSTICAS TÉCNICAS PAVIMENTO PASTA ROJA / TECHNICAL FEATURES CERAMIC FLOOR TILES

	GRUPO BIla (GL) 3% < Absorción de agua < 6% GROUP BIla (GL) 3% < Water absorption < 6%	NORMAS DE ENSAYO STANDARD	VALORES PRESCRITOS NORMA EN 14411 / VALUE REQUIRED BY EN 14411 STANDARD	VALOR MEDIO AVERAGE VALUE
	Características dimensionales Dimensional features	ISO 10545-2		Cumple la norma Conforms to standard Satisfait à la norme
	Absorción de agua Water absorption	ISO 10545-3	3% < E < 6%	5%
	Resistencia a la flexión Modulus of rupture Fuerza de rotura Breaking strength	ISO 10545-4	> 22 N / mm² > 1000 N	30 - 40 N / mm2 1100 - 1900 N
	Resistencia a la abrasión superficial Resistance to surface abrasion	ISO 10545-7	Clase indicada por el fabricante Abrasion class indicated by the manufacturer	No aplica Not apply
	Dilatación térmica lineal Linear thermal expansion	ISO 10545-8	Método de ensayo disponible Test method available	<7,0 x 10-6 °C-1
	Resistencia al choque térmico Thermal shock resistance	ISO 10545-9	Método de ensayo disponible	Resiste Resists
	Resistencia al cuarteo Crazing resistance	ISO 10545-11	Exigida Required	Resiste Resists
	Resistencia química Chemical resistance	ISO 10545-13	Método de ensayo disponible Test method available Mínimo GB Minimum GB	Cumple la norma Conforms to standard / Clase GA Class GA
	Resistencia a las manchas Resistance to stains	ISO 10545-14	Mínimo clase 3 Minimum class 3	Cumple la norma Conforms to standard

CARACTERÍSTICAS TÉCNICAS GRES PORCELÁNICO ESMALTADO / TECHNICAL FEATURES GLAZED PORCELAIN TILES

	GRUPO BIa (GL) Absorción de agua < 0,5% GROUP BIa (GL) Water absorption < 0,5%	NORMAS DE ENSAYO STANDARD	VALORES PRESCRITOS NORMA EN 14411 / VALUE REQUIRED BY EN 14411 STANDARD	VALOR MEDIO AVERAGE VALUE
	Características dimensionales Dimensional features	ISO 10545-2		Cumple la norma Conforms to standard
	Absorción de agua / Water absorption	ISO 10545-3	< 0,5%	0,1%
	Resistencia a la flexión Modulus of rupture Fuerza de rotura Breaking strength	ISO 10545-4	> 35 N / mm2 > 1300 N	35 - 45 N / mm2 1600 - 2400 N
	Resistencia a la abrasión superficial Resistance to surface abrasion	ISO 10545-7	Clase indicada por el fabricante Abrasion class indicated by the manufacturer /	Según Modelos According to models
	Dilatación térmica lineal Linear thermal expansion	ISO 10545-8	Método de ensayo disponible Test method available	<7,0 x 10-6 °C-1
	Resistencia al choque térmico Thermal shock resistance	ISO 10545-9	Método de ensayo disponible Test method available	Resiste Resists
	Resistencia al cuarteo Crazing resistance	ISO 10545-11	Exigida Required	Resiste Resists
	Resistencia a la helada / Frost resistance	ISO 10545-12	Método de ensayo disponible Test method available	Resiste Resists
	Resistencia química Chemical resistance	ISO 10545-13	Método de ensayo disponible Test method available Mínimo GB Minimum GB	Cumple la norma Conforms to standard Clase GA Class GA
	Resistencia a las manchas Resistance to stains	ISO 10545-14	Mínimo clase 3 Minimum class 3	Cumple la norma Conforms to standard
	GRUPO BIb (GL) Absorción de agua 0,5% < E < 3% GROUPE BIb (GL) Water absorption 0,5% < E < 3%	NORMAS DE ENSAYO STANDARD	VALORES PRESCRITOS NORMA EN 14411 / VALUE REQUIRED BY EN 14411 STANDARD	VALOR MEDIO AVERAGE VALUE
	Características dimensionales Dimensional features	ISO 10545-2		Cumple la norma Conforms to standard
	Absorción de agua Water absorption	ISO 10545-3	0,5% < E < 3%	2%
	Resistencia a la flexión Modulus of rupture Fuerza de rotura Breaking strength	ISO 10545-4	> 30 N / mm2 > 1100 N	30 - 40 N / mm2 > 1100 N
	Resistencia a la abrasión superficial Resistance to surface abrasion	ISO 10545-7	Clase indicada por el fabricante Abrasion class indicated by the manufacturer	Según Modelos According to models
	Dilatación térmica lineal Linear thermal expansion	ISO 10545-8	Método de ensayo disponible Test method available	<7,0 x 10-6 °C-1
	Resistencia al choque térmico Thermal shock resistance	ISO 10545-9	Método de ensayo disponible Test method available	Resiste Resists
	Resistencia al cuarteo Crazing resistance	ISO 10545-11	Exigida Required	Resiste Resists
	Resistencia química Chemical resistance	ISO 10545-13	Método de ensayo disponible Test method available Mínimo GB Minimum GB	Cumple la norma Conforms to standard Clase GA Class GA
	Resistencia a las manchas Resistance to stains	ISO 10545-14	Mínimo clase 3 Minimum class 3	Cumple la norma Conforms to standard

	GRUPO BIa (GL) Absorción de agua < 0,5% GROUP BIa (GL) Water absorption < 0,5%	NORMAS DE ENSAYO STANDARD	VALORES PRESCRITOS NORMA EN 14411 / VALUE REQUIRED BY EN 14411 STANDARD	VALOR MEDIO AVERAGE VALUE
	Características dimensionales Dimensional features	ISO 10545-2		Cumple la norma Conforms to standard
	Absorción de agua Water absorption / Absorption d'eau	ISO 10545-3	< 0,5%	0,1%
	Resistencia a la flexión Modulus of rupture	ISO 10545-4	> 35 N / mm ² > 1300 N	35 - 45 N / mm ² 1600 - 2400 N
	Resistencia a la abrasión profunda (mm ³) Resistance to deep abrasion (mm ³) / Résistance à l'abrasion profonde (mm ³)	ISO 10545-6	Máx. 175 mm ³	110 - 130 mm ³
	Dilatación térmica lineal / Linear thermal expansion / Dilatation thermique linéaire	ISO 10545-8	Método de ensayo disponible Test method available	<7,0 x 10 ⁻⁶ °C ⁻¹
	Resistencia al choque térmico Thermal shock resistance / Résistance au choc thermique	ISO 10545-9	Método de ensayo disponible Test method available	Resiste Resists
	Resistencia a la helada Frost resistance / Résistance au gel	ISO 10545-12	Método de ensayo disponible Test method available	Resiste Resists
	Resistencia química Chemical resistance	ISO 10545-13	Método de ensayo disponible Test method available Mínimo UB Minimum UB	Cumple la norma Conforms to standard Clase UA Class UA
	Resistencia a las manchas Resistance to stains	ISO 10545-14	Mínimo clase 3 Minimum class 3	Cumple la norma Conforms to standard
	Resistencia al deslizamiento Slip Resistance	DIN 51130 DIN 51097 UNE-ENV 12633 ASTM C 1028		Según Modelos According to models



FOLLOW OUR LATEST NOVELTIES

En Navarti, apostamos por un futuro más limpio. Es por ello que hemos creado este apartado con el fin de mantener actualizado el catálogo a tiempo real y poder compartir las últimas novedades de una manera más dinámica.

Escanea nuestro QR y descubre más...

At Navarti, we are committed to a brighter future cleansed. That is why we have created this section in order to keep updated the catalog in real time and being able to share the latest news in a more dynamic.

Scan our QR and discover more...

scan me



NAVARTI

cerámica

La reproducción de los colores es aproximada.

Navarti se reserva el derecho de alterar o modificar los productos aquí relacionados.

The reproduction of the colors is approximate.

Navarti reserves the right to alter or amend the products here stated.

Los códigos de precios y referencias deben verificarse ya que puede haber errores tipográficos. Es recomendable consultar la web ya que cualquier producto de este catálogo puede sufrir cambios en códigos de venta, formatos o packing.

Price codes and product codes should be checked, since there may be typographical errors. We always recommend consulting the website as the products could undergo price code, format or packing changes.

En la web también pueden consultar las características técnicas, consejos de colocación , elementos de merchandising o los diversos ambientes de cada una de las colecciones.

On the website you can also find the technical specifications, installation suggestions, merchandising elements and a variety of room scene pictures for each of the inspirations.